

DIGITAL COMBAT SIMULATOR

# F/A-18C



F/A-18C

Early Access  
Guide



Updated 18 July 2023



# INTRODUCTION

Thank you for your purchase of DCS: F/A-18C!

DCS: F/A-18C brings to Digital Combat Simulator an iconic aircraft of modern naval aviation. This module features the most realistic PC simulation of the F/A-18C, which includes accurately simulated flight dynamics, avionics, sensors, and weapon systems. This module simulates the F/A-18C as it existed in United States Navy and Marine Corps service circa 2005.

The F/A-18C is one of the most successful naval strike fighters in modern history; and has served as the backbone of U.S. Navy carrier air wings for decades, as well as serving in the air forces of several other nations ranging from Europe, to the Middle East, to the Pacific region. Known for its dual-role design, mission versatility, and of course its ability to operate from aircraft carriers at sea, the F/A-18C is also one of the most maneuverable aircraft in close-range air-to-air combat with a robust fly-by-wire control system and high angle-of-attack capabilities.

When used in conjunction with the [DCS: Supercarrier](#) module, the DCS: F/A-18C gives DCS players the most authentic U.S. Naval Aviation experience available for the PC, short of strapping on a G-suit yourself and tasting the salty air first-hand.

Hook up, salute, and launch yourself into naval aviation!

Key features:

- Detailed, fully-clickable, 6DOF cockpit along with a highly detailed external model.
- APG-73 Fire Control Radar (with air-to-air and air-to-ground modes), ATFLIR and Litening II targeting pods, and Joint Helmet Mounted Cueing System (JHMCS).
- Air-to-air weapons include the M61 20mm Vulcan cannon, AIM-9 Sidewinder heat-seeking missiles, AIM-7 Sparrow semi-active radar-homing missiles, and AIM-120 AMRAAM active radar-homing missiles.
- A large assortment of air-to-ground munitions, including (but not limited to) AGM-88 HARM anti-radar missiles, AGM-65 IR- and laser-guided Maverick anti-armor missiles, AGM-84D Harpoon anti-ship missiles, AGM-84E/H SLAM long-range attack missiles, AGM-62 Walleye TV-guided glide bombs, AGM-154 JSOW glide bombs, JDAM inertially aided munitions, and Paveway laser-guided bombs.
- DL16 datalink, providing a high degree of situational awareness and teamwork between wingmen.
- ALR-67(V) radar warning receiver, ALE-47 countermeasure dispensers, and ALQ-165 ECM jamming system.
- Complete integration with DCS: Supercarrier module.
- Fly missions in the Black Sea region or one of the many DLC maps like the Persian Gulf, Syria, and more.
- Multiplayer cooperative and head-to-head gameplay.
- Feature-rich Mission and Campaign editors allow user-created content.
- Huge array of land, air, and sea units to flight along and against.

Sincerely,  
The DCS: F/A-18C Team  
30 May 2018

## Disclaimers

*The manufacturers and intellectual property right owners of the vehicles, weapons, sensors, and other systems represented within DCS World in no way endorse, sponsor or are otherwise involved in the development of DCS World and its modules.*

*This software is for entertainment purposes only.*

*The appearance of U.S. Department of Defense (DoD) visual information does not imply or constitute DoD endorsement.*

# TABLE OF CONTENTS

Introduction .....	2
Table of Contents .....	3
Latest Changes .....	11
<b>DCS: WORLD FUNDAMENTALS .....</b>	<b>13</b>
Health Warning!.....	14
Installation and Launch .....	15
Configure Your Game .....	16
Fly a Mission .....	21
Game Problems.....	21
Useful Links .....	21
Flight Control.....	22
Changing Airspeed .....	23
Changing Altitude.....	23
Changing Heading .....	23
<b>THE F/A-18C .....</b>	<b>25</b>
Aircraft History .....	26
The VFAX Programs.....	26
The YF-17 "Cobra" .....	27
Development of the F-18 .....	28
F/A-18A and B Deployment.....	29
F/A-18C and D Deployment.....	29
Weapons & Munitions.....	31
M61A1 Vulcan 20mm Cannon.....	31
AIM-9 Sidewinder .....	31
AIM-120 AMRAAM .....	32
AIM-7 Sparrow.....	32
AGM-154 Joint Standoff Weapon (JSOW).....	33
AGM-84 Harpoon, SLAM, and SLAM-ER.....	33
AGM-88 HARM .....	34
AGM-65 Maverick .....	34
AGM-62 Walleye II .....	34
Mk. 20 Rockeye and CBU-99 .....	35
Paveway II Laser Guided Bomb.....	35

Paveway III Laser Guided Bomb.....	35
Joint Direct Attack Munition (JDAM).....	36
Mark 80-Series General-Purpose Bomb .....	36
Rockets .....	37
Fuel Tanks .....	37
AN/ASQ-228 ATFLIR.....	37
AN/AAQ-28 Litening II Targeting Pod .....	37
AN/AWW-13 Advanced Datalink .....	37
AN/ASQ-T50 TCTS Pod .....	38
Training Bombs.....	38
Cockpit Overview .....	39
Left Instrument Panel .....	40
Center Instrument Panel.....	45
Heads-Up Display (HUD).....	45
Right Instrument Panel .....	53
Left Vertical Panel .....	58
Left Console.....	61
Right Vertical Panel .....	64
Right Console.....	67
Audio Tones.....	71
Control Stick & Throttles.....	72
Control Stick .....	72
Throttles .....	75
Heads-Up Display (HUD) .....	79
Digital Display Indicator (DDI) & Advanced Multi-Purpose Color Display (AMPCD) Pages .....	81
Support (SUPT) Pages .....	81
Tactical (TAC) Pages .....	91
<b>PROCEDURES .....</b>	<b>94</b>
Cold Start.....	95
Airfield Taxi .....	102
Airfield Takeoff .....	103
Airfield VFR Landing.....	104
Aircraft Carrier Taxi.....	107
Aircraft Carrier Launch .....	110
Case 1 Carrier Recovery .....	111

<b>NAVIGATION</b> .....	<b>117</b>
Navigation.....	118
INS Alignment.....	118
Alignment Procedure.....	119
Waypoint Navigation.....	124
Time on Target (TOT) Navigation.....	126
Modifying a Waypoint.....	129
Offset Aimpoints.....	129
Adding or Deleting a Waypoint.....	136
Inserting a Waypoint.....	137
Entering GRID Coordinates.....	137
TACAN Navigation.....	139
TACAN Yardstick.....	141
DATA Option Sublevel.....	142
A/C (Aircraft) Sublevel.....	142
WYPT (Waypoint) Sublevel.....	143
TCN (TACAN) Sublevel.....	144
Automatic Direction Finder (ADF) Navigation.....	146
Additional HSI Symbology.....	147
Setting a Course.....	148
Autopilot Relief Modes.....	149
Using Coupled Autopilot Mode.....	150
Instrument Carrier Landing System (ICLS).....	153
<b>RADIO COMMUNICATIONS</b> .....	<b>155</b>
Voice Communications.....	156
UFC Radio Functions.....	157
<b>APG-73 FIRE CONTROL RADAR</b> .....	<b>159</b>
Air-to-Air Radar.....	160
Basic Air-to-Air Radar Information.....	160
A/A Waypoint and Bearing and Range.....	161
Range While Search (RWS) Mode.....	165
Single Target Track (STT) Mode.....	168
Spotlight (SPOT) Sub-Mode.....	171
Air-to-Air Radar HOTAS Controls.....	172
Range While Search (RWS) DATA.....	174

Air Combat Maneuvering (ACM) Modes .....	175
Track While Scan (TWS) Mode for the F/A-18C .....	177
Latent Track While Scan (LTWS) Mode .....	181
AZ/EL Format .....	185
Expand Mode .....	188
FLIR Sensor Mode .....	188
HOTAS Controls .....	189
Changing Radar Scan Centerpoint .....	190
Air-to-Ground Radar .....	191
Display Controls .....	191
AG Radar Display .....	193
HOTAS Controls .....	194
AG Radar Search Modes Operation .....	195
Radar Tracking Designations .....	202
<b>DL16 DATALINK .....</b>	<b>204</b>
DL16 Datalink & MIDS .....	205
MIDS MFD Format .....	206
MIDS DL16 UFC Control .....	207
MIDS Secure Voice .....	208
MSI Trackfiles .....	208
Situational Awareness (SA) Page .....	209
SA Sensor Sub-Level .....	212
HAFU Symbology .....	214
Target Under Cursor (TUC) Data .....	218
Correlated HUD Indication .....	220
<b>ADVANCED TARGETING FORWARD LOOKING INFRARED POD .....</b>	<b>221</b>
AN/ASQ-228 ATFLIR .....	222
Sensor Control Panel .....	222
ATFLIR Activation .....	223
Air-to-Ground Mode .....	225
Tracking Modes .....	228
Using the LTD/R and LST .....	229
SETUP Menu .....	230
Setting Laser Codes .....	231
Designating and Tracking Ground Targets .....	232

Designating Targets Using the Laser.....	233
Using Laser Spot Tracking.....	233
Manually Controlling Level and Gain .....	234
Air-to-Air Mode .....	236
Acquiring Air Targets .....	236
<b>LITENING II TARGETING POD .....</b>	<b>238</b>
AN/AAQ-28 Litening II.....	239
Targeting Pod Activation .....	240
Air-to-Ground (A/G) Mode .....	242
Locating and Tracking Surface Targets .....	245
Designating Targets Using the Laser.....	246
Using Laser Spot Tracking.....	247
Air to Air (AA) Page.....	249
Tracking Aircraft.....	251
<b>JOINT HELMET-MOUNTED CUEING SYSTEM .....</b>	<b>252</b>
Helmet Mounted Display (HMD).....	253
HMD Power.....	253
HMD Built-In Tests .....	253
HMD Alignment .....	254
HMD Format DDI Page .....	257
Basic HMD Information .....	260
AIM-9 Undesignated Target .....	261
AIM-9 Self-Track .....	261
AIM-120 and AIM-7 Undesignated .....	261
HMD ACM Modes.....	262
A/A Designated Target .....	263
<b>AIR-TO-AIR EMPLOYMENT.....</b>	<b>265</b>
Air-to-Air Master Mode .....	266
M61A1 Gun, Air-to-Air Mode (A/A GUNS).....	267
A/A GUNS SMS Page.....	267
A/A GUNS HUD .....	269
Radar Tracking Mode.....	272
Training Mode with FEDS Cue .....	275
AIM-9 Sidewinder Air-to-Air Missile .....	276
AIM-9 on the SMS Page.....	276

AIM-9 HUD .....	278
AIM-7 Sparrow Air-to-Air Missile .....	284
AIM-7 SMS Page .....	284
AIM-7, No Radar Tracking.....	286
AIM-7, Radar Tracking.....	288
AIM-7 with L&S Target .....	290
AIM-120 Advanced Medium Range Air-to-Air Missile (AMRAAM) .....	293
AIM-120 SMS Page.....	293
AIM-120, No Radar Tracking .....	295
AIM-120, Radar Tracking Pre-Launch.....	297
AIM-120, Radar Tracking Post-Launch .....	301
<b>AIR-TO-GROUND EMPLOYMENT .....</b>	<b>303</b>
Air-to-Ground Master Mode .....	304
Air-to-Ground Markpoints .....	305
Designating Markpoints .....	305
Getting Markpoint Coordinates .....	306
Navigating to Markpoints .....	307
Air-to-Ground SMS Bombing Page.....	308
A/G Stores Programming .....	310
Air-to-Ground Bombing HUD.....	312
Unguided CCIP Bombing Mode HUD .....	312
Automatic (AUTO) Bombing Mode HUD .....	315
Manual (MAN) Bombing Mode HUD .....	321
High Drag (HD) Bomb Delivery.....	322
JHMCS Air-to-Ground Mode .....	323
Laser-Guided Bombing .....	326
Paveway II Series.....	326
Paveway III Series .....	328
INS/GPS-Guided Weapons.....	334
Weapon Selection.....	335
Air-to-Ground Gun and Rockets .....	347
A/G Gun SMS Page.....	348
Rockets SMS Page.....	349
A/G Gun and Rocket HUD .....	350
AGM-65 Maverick.....	352



AGM-65E Laser-Maverick on SMS Page .....	352
AGM-65E Laser-Maverick Format Page, Unlocked .....	354
AGM-65E Laser-Maverick Format Page, Locked .....	355
AGM-65E Format and Setting Laser Codes .....	357
How to Launch an AGM-65E.....	357
AGM-65F Infrared-Guided Maverick on SMS Page.....	358
AGM-65F Infrared Maverick Format Page.....	360
AGM-65F Infrared Maverick Targeting .....	362
AGM-65F Infrared Maverick Tracking .....	364
AGM-88 HARM.....	366
Loading .....	366
HOTAS .....	366
HARM Select .....	366
Self-Protect (SP) Mode.....	369
Target Of Opportunity (TOO) Mode .....	373
Pre-Briefed (PB) Mode .....	379
AGM-84D Harpoon.....	383
Harpoon SMS Format.....	383
Harpoon HSI .....	386
Harpoon HUD.....	387
AGM-84E Stand-Off Land Attack Missile (SLAM) .....	388
Weapon Selection.....	388
SLAM Stores Format .....	388
SLAM and Datalink SMS Page.....	389
SLAM and Datalink Pod Combined Employment.....	396
SLAM Terminal Seeker .....	398
SLAM HSI Format.....	400
SLAM HUD .....	401
AGM-84H SLAM-ER (Expanded Response) .....	402
Creating a SLAM-ER Turn Points (STPs).....	402
AWW-13 Datalink Format.....	403
AGM-62 Walleye II ER/DL with AWW-13 Datalink Pod .....	406
Walleye SMS Page.....	407
AN/AWW-13 Datalink Pod Only Selected .....	407
Walleye Only Selected .....	408

Walleye and Datalink Pod Both Selected .....	410
Walleye HUD.....	412
<b>DEFENSIVE SYSTEMS .....</b>	<b>413</b>
Integrated Countermeasures Control Panel (ICMCP) .....	414
EW Page .....	416
EW Symbols.....	418
EW BIT .....	418
ALR-67(V) Azimuth Indicator .....	419
ALR-67(V) Control Indicator Panel .....	420
Right Instrument Panel Warning / Advisory / Threat Display Panel .....	421
Airborne Self-Protection Jammer (ASPJ) .....	422
Employing the ASPJ.....	424
HOTAS Controls.....	425
<b>APPENDICES .....</b>	<b>426</b>
ALIC Codes & RWR Symbols Appendix .....	427
Air Defense Radar Systems .....	427
Naval Radar Systems.....	428
Airborne Radar Systems.....	429
Other Threat Symbols.....	429
Formulas Appendix .....	430
Fuel/Endurance Calculations .....	430
Speed/Time/Distance Calculations.....	430
Fuel/Range Calculations.....	430
Distance Conversion .....	430
Altitude/Elevation Conversion.....	430
Latitude/Longitude Conversion .....	430

# LATEST CHANGES

Significant changes to the guide will be noted on this page.

## Jun 2019

- TACAN Yardstick
- HSI DATA, A/C (Aircraft) Sublevel
- HSI DATA, WYPT (Waypoint) Sublevel
- PRECISE Coordinate Entry
- LAT/LONG Option from HSI/DATA A/C
- Updated information on bomb fuzing
- Additional detail and images regarding AUTO bombing mode
- High drag bomb section
- Laser-Guided Bombing
- INS/GPS-Guided Weapons
- AGM-65 Maverick
- AGM-88 HARM
- Bullseye and BRA Indications
- Latent Track While Scan (LTWS) Mode
- Multi-Sensor Integration (MSI)
- Single Target Track (STT) Mode
- Datalink, Situational Awareness Page, and IFF
- A/A Gun, Training Mode with FEDS Cue
- AIM-9 Sidewinder Air-to-Air Missile
- AIM-7, FLOOD Mode
- Helmet Mounted Display (HMD)

## Dec 2019

- Track While Scan (TWS) Mode
- AGM-84D Harpoon
- AGM-62 Walleye II ER/DL with AWW-13 Datalink Pod

## Sep 2020

- Air-to-Ground Radar, MAP and EXP modes
- INS/GPS-Guided SMS options
- AGM-84E Stand-Off Land Attack Missile (SLAM)

## Nov 2020

- Entering GRID Coordinates
- AZ/EL Format
- Litening II Targeting Pod
- JHMCS Air-to-Ground Mode
- Air-to-Ground Markpoints

## Dec 2020

- MIDS MFD Format
- Paveway III Series laser-guided bombs

- AZ/EL surveillance data

**Jan 2021**

- TXDSG functionality
- Aircraft History
- Employing the ASPJ

**Feb 2021**

- F/A-18C stores

**Mar 2021**

- Spotlight (SPOT) Sub-Mode
- AN/ASQ-228 ATFLIR

**May 2021**

- HARM Pre-Briefed (PB) Mode
- WACQ Uncaged Mode

**Jun 2021**

- AGM-84H SLAM-ER (Expanded Response)
- Offset Aimpoints
- One-Look RAID

**Jul 2021**

- HMD Alignment

**Mar 2023**

- Update to new manual formatting and structure
- Updated Appendix with latest ALIC codes, HARM classes, and RWR symbols

**Author's note:** The DCS F/A-18C Early Access Guide has been migrated to a new standardized format and structure. As part of this update, several user-reported errors or confusing descriptions have been updated. In addition, the appendix at the end of the manual that lists hostile radar symbols with their corresponding ALIC codes and HARM classes has also been updated to reflect the current threat radars within DCS World.

As a whole, the F/A-18C Early Access Guide requires a larger revision to not only bring it up to date with the current state of the DCS F/A-18C module, but to bring it up to the high standards that are expected of DCS aircraft modules. It is my intention to complete the F/A-18C manual with the same level of dedication and attention to detail; however this process will take time (as similar updates are being performed for the A-10C, A-10C II, F-16C, and AH-64D manuals), and I appreciate your patience.

# DCS: WORLD FUNDAMENTALS



US Navy photo  
by PO2 James Evans

# HEALTH WARNING!

Please read before using this computer game or allowing your children to use it.

A very small proportion of people may experience a seizure or loss of consciousness when exposed to certain visual images, including flashing lights or light patterns that can occur in computer games. This may happen even with people who have no medical history of seizures, epilepsy, or "photosensitive epileptic seizures" while playing computer games.

These seizures have a variety of symptoms, including light-headedness, dizziness, disorientation, blurred vision, eye or face twitching, loss of consciousness or awareness even if momentarily.

Immediately stop playing and consult your doctor if you or your children experience any of the above symptoms.

The risk of seizures can be reduced if the following precautions are taken, (as well as a general health advice for playing computer games):

Do not play when you are drowsy or tired.

Play in a well-lit room.

Rest for at least 10 minutes per hour when playing the computer game.

# INSTALLATION AND LAUNCH

To install DCS World and the DCS: F/A-18C module, you will need to be logged into Windows with Administrator rights.

DCS World is the PC simulation environment that the DCS: F/A-18C simulation operates within. When DCS World is launched, you in turn launch DCS: F/A-18C.

As part of DCS World, a map of the Caucasus region, the Su-25T "Frogfoot" attack aircraft, and TF-51 training aircraft are also included for free.

After purchasing DCS: F/A-18C from our e-Shop, start DCS World by executing the icon on your desktop. Upon initialization, the DCS World Main Menu page is opened. From the Main Menu, you can read DCS news, change your wallpaper by selecting any of the icons at the bottom of the page, or select any of the options along the right side of the page.

Select the Module Manager icon at the top of the Main Menu. Upon initial entry into the Module Manager, a pop-up window titled Install Modules should automatically display, listing any DCS products that you have purchased and have yet to install. Ensure DCS: F/A-18C is checked, and then click OK. Alternatively, you can select the Modules tab, scroll down until you locate the DCS: F/A-18C entry, and click Install. In either case, DCS World will close and automatically proceed with an update to download and install the necessary files. After the download and installation is complete, DCS World will automatically restart.

To get started quickly, you can select Instant Action and play any of the missions listed for the F/A-18C.

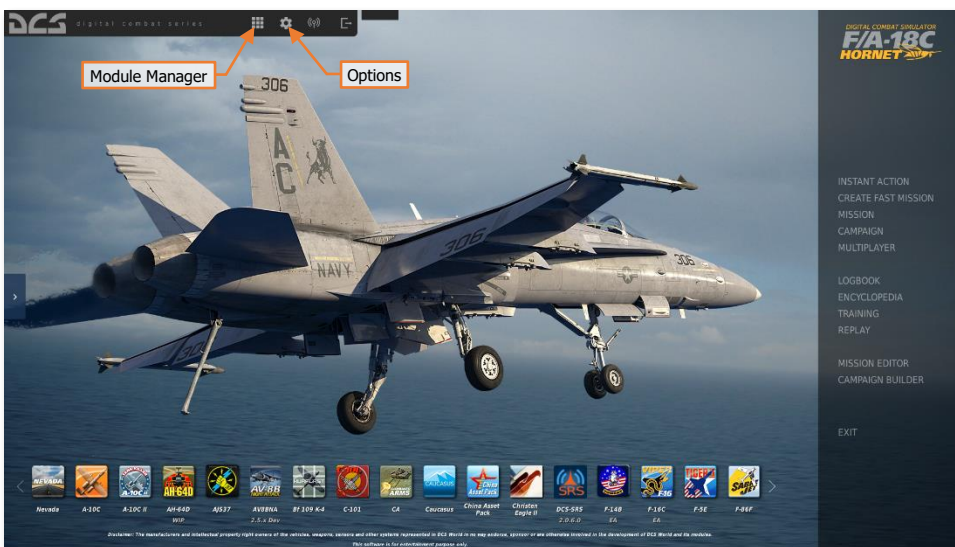

## Configure Your Game

Before jumping into the cockpit, the first thing we suggest is to configure your game. To do so, select the Options button at the top of the Main Menu screen. You can read a detailed description of all Options in the DCS User Manual. For this Early Access Guide, we will just cover the basics.

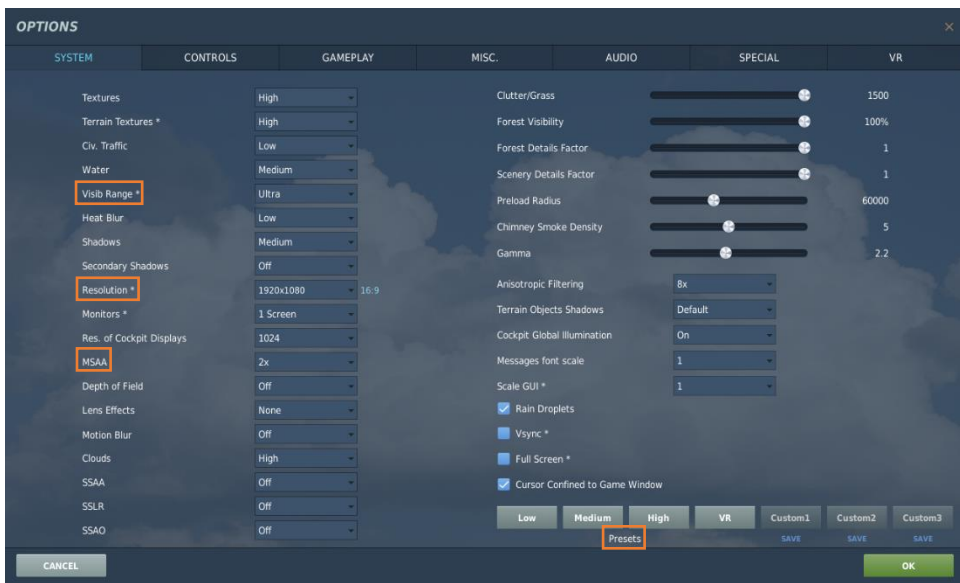

**SYSTEM Tab.** This tab allows you to configure your graphics options to best balance aesthetics with performance.

There are **Presets** options along the bottom of the page, but you can further adjust your graphics settings to best suit your computer. If you have lower performance, we suggest selecting the "Low" button and then increase graphics options to find your best balance.

Items that most affect performance include **Visibility Range**, **Resolution**, and **MSAA**. If you wish to improve performance, you may wish to first adjust these system options.

Items that have an asterisk (\*) displayed next to them will require a restart of DCS World to take effect.

Note that some missions may enforce different Civ. Traffic settings that override the individual user selection on this tab. This may result in higher or lower levels of expected civilian traffic scenery, or none at all.



**CONTROLS Tab.** This tab provides an interface to set up your controls and functional bindings.

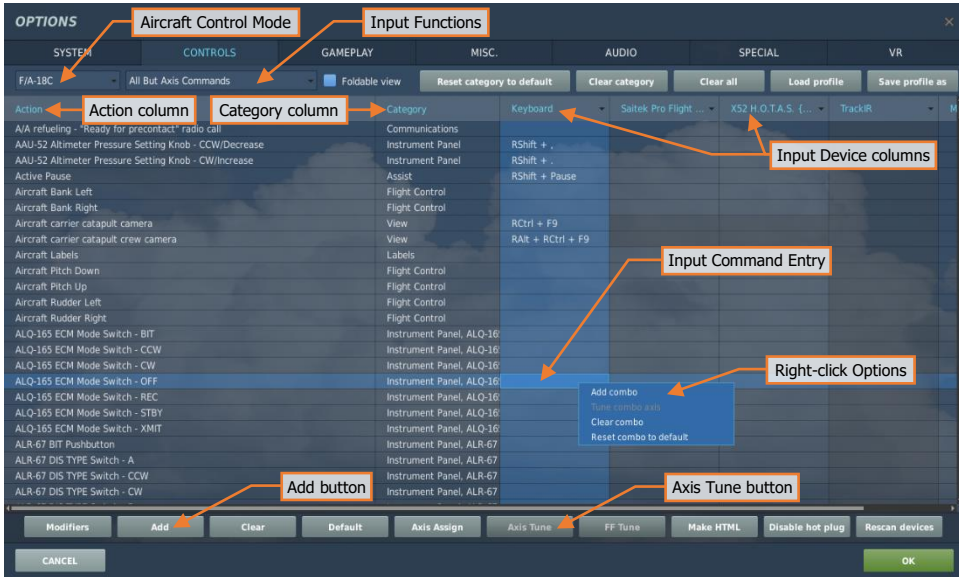

- **Aircraft Control Mode.** From this drop-down menu, select "F/A-18C".
- **Input Functions.** This displays various categories of input functions, such as axis devices, views, cockpit functions, etc. Additionally, "Search..." can be selected from the Input Functions drop-down to manually filter the Action column according to keyword matches.
- **Action column.** This column along the left side of the screen displays the action associated with the corresponding input command entries.
- **Category column.** This column to the right of the Action column displays the function group or cockpit panel each Action is grouped within.
- **Input Device columns.** These columns display which input devices have been detected, including your keyboard, mouse, joysticks, throttles, or rudder pedals, and which input commands from the respective input devices will perform the corresponding Action.
- **Add button.** To assign an input command to an Action, left-click the input command entry that corresponds with the desired Action under the desired input device column, then press the Add button along the bottom row. Alternatively, a double left-click on the desired command entry using mouse can be used, or right-clicking on the command entry and selecting "Add combo". Any of these methods will display the ASSIGNMENT PANEL.

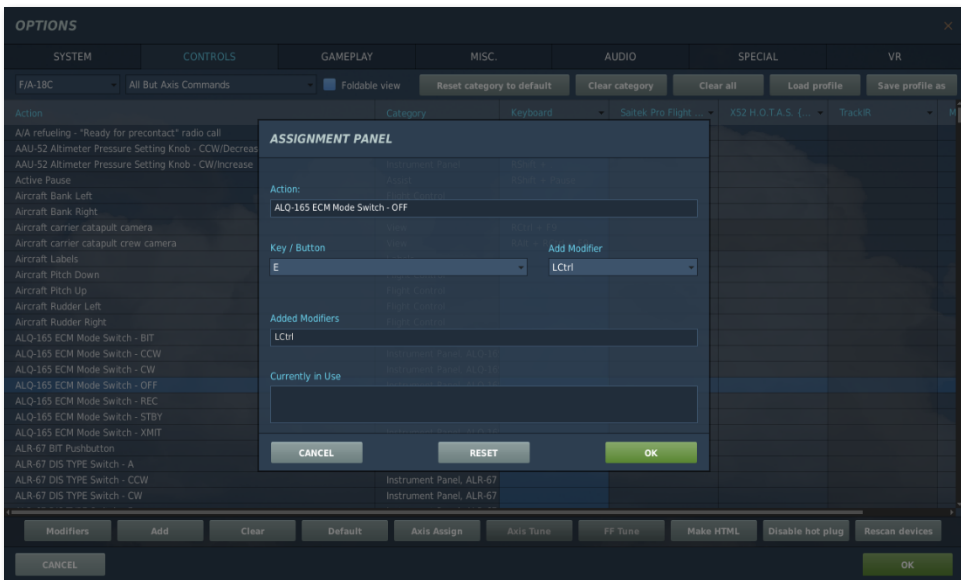

- **ASSIGNMENT PANEL.** When this panel is displayed, simply press the button (or combination of buttons) or move the axis of the device to assign it to that Action.
  - *Example 1:* If setting a pitch axis for a joystick, first select **AXIS COMMANDS** from the Input Functions drop down. Find the box where your Joystick input device and the "Pitch" Action intersect and double-click the left mouse button in the box. In the **ASSIGNMENT PANEL**, move your joystick forward and back to assign the axis. Press **OK** when finished.
  - *Example 2:* If setting a keyboard or controller device button, first select **All But Axis Commands** as the Input Function category, or the category that contains the desired Action you wish to edit. Find the box where your input device and the Action intersect, and double-click the left mouse button in the box. In the **ASSIGNMENT PANEL**, press the keyboard or controller device button you wish to assign to the Action. Press **OK** when finished.
  - If you make a mistake during the assignment process, press the **RESET** button and try again.
  - If another Action is already assigned to that button or button combination, that Action will be shown under **Currently In Use**.
- **Default button.** After assigning a command to an Action, you may revert to the default command assignment for that command entry by clicking on the corresponding entry to highlight, and then clicking the **Default** button. This can also be accomplished by right-clicking on the command entry and selecting "Reset combo to default".
- **Clear button.** If you wish to remove all commands from an input device for that Action, click on the corresponding command entry to highlight, and then click the **Clear** button. This can also be accomplished by right-clicking on the command entry and selecting "Clear combo".
- **Axis Tune button.** This button becomes available if an axis command entry is highlighted. When this button is clicked, the **AXIS TUNE PANEL** is displayed. This can also be accomplished by right-clicking on the command entry and selecting "Tune combo axis".

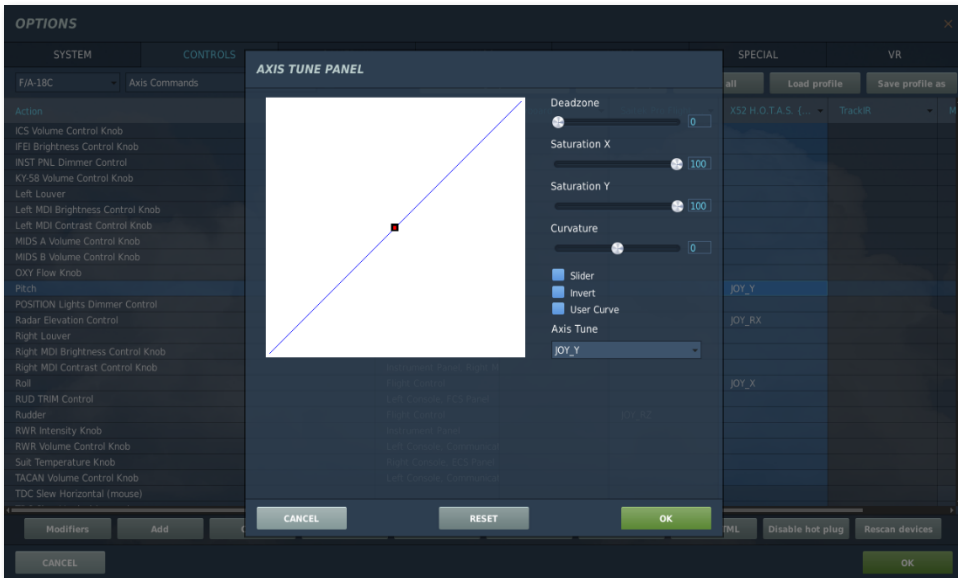

- **AXIS TUNE PANEL.** When this panel is displayed, the selected axis can be assigned a dead zone, different response curves, and other tuning.

**GAMEPLAY Tab.** This tab primarily allows you to adjust the game to be as realistic or casual as you want it to be. Choose from various difficulty settings like labels, tooltips, unlimited fuel and weapons, etc. You can also set your preferred language and units of measurement.

Turning Mirrors off can assist with improving performance.

Note that some missions may enforce different gameplay settings that override the individual user selection on this tab. This may result different gameplay behavior than the user expects, such as enforcing no labels or restricting information on the F10 map.

**MISC Tab.** This tab contains miscellaneous features to further tune the game to your preference.

Note that some missions may enforce different gameplay settings that override the individual user selection on this tab. This may result different gameplay behavior than the user expects, such as enforcing no external views or Battle Damage Assessment overlays.

**AUDIO Tab.** Use this tab to adjust the audio levels within the game, enable/disable various audio effects, or manage your Voice Chat settings.

**SPECIAL Tab.** Use this tab to modify module-specific options by selecting the DCS: F/A-18C from the module list along the left side of the screen.

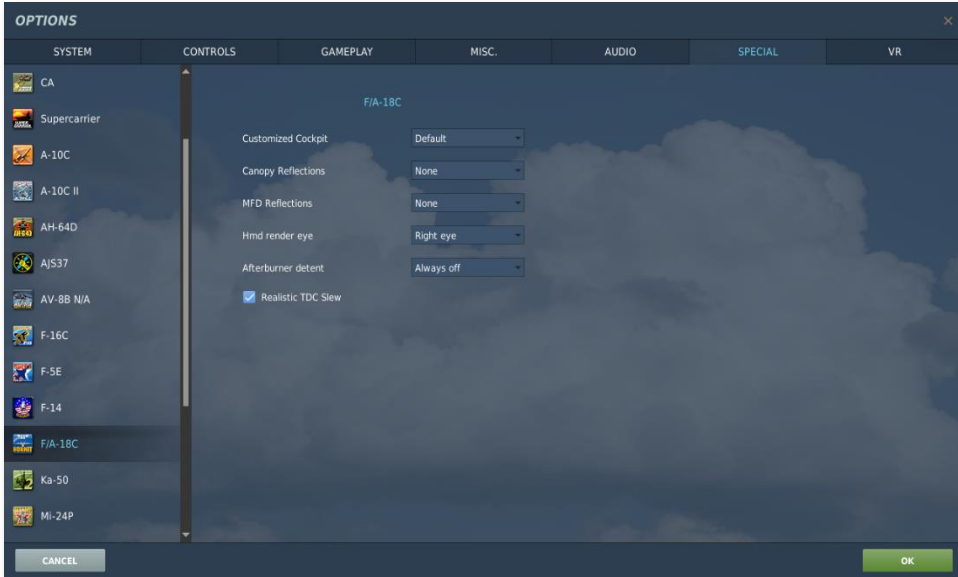

- **Customized Cockpit.** Only one option is available at this time, set to "Default".
- **Canopy Reflections.** May be set to "None" or "Static".
- **MFD Reflections.** May be set to "None" or "Static".
- **HMD Render Eye.** May be set to "Right eye", "Left Eye" or "Both eyes." When using a VR headset, this will determine which eyepiece(s) render the JHMCS flight symbology.
- **Afterburner Detent.** May be set to "Always off", "Carrier only", or "Always on".
  - **Always off.** In-game throttle will enter afterburner range based on throttle axis input by the user.
  - **Carrier only.** When operating onboard an aircraft carrier, Throttle Quadrant action "Cycle Afterburner Detent – ON/OFF" will determine whether the in-game throttle will enter into afterburner range with throttle axis input by the user.
  - **Always on.** Throttle Quadrant action "Cycle Afterburner Detent – ON/OFF" will always determine whether the in-game throttle will enter into afterburner range with throttle axis input by the user.
- **Realistic TDC Slew.** Throttle Grip action "Throttle Designator Controller – DEPRESS" is required to be simultaneously and continuously depressed for TDC Slew inputs to be recognized. Un-checking this option removes this requirement for user input hardware that does not permit such action.

**VR Tab.** This tab allows you to enable support for a wide variety of VR Headsets and adjust their functionality. When using VR, be particularly aware of the Pixel Density setting as it can have a dramatic effect on game performance.

## Fly a Mission

Now that you have configured your game, let's get to why you purchased DCS: F/A-18C, to fly some missions! You have several options to fly a single or multi-player mission.

On the Main Menu page, you have the options to fly the F/A-18C in an INSTANT ACTION mission, CREATE FAST MISSION, load a MISSION, play a CAMPAIGN, go through a TRAINING lesson, or create a mission in the MISSION EDITOR. You also have the option to jump online and fly with others in MULTIPLAYER.

- **INSTANT ACTION.** Simple missions that place you in the task of your choice. These missions are grouped according to which map they take place in, so selecting a different map from the list along the right side of the Instant Action mission list may provide additional missions to choose from.
- **CREATE FAST MISSION.** Set various mission criteria to allow a mission to be created for you.
- **MISSION.** More in-depth, stand-alone combat missions.
- **CAMPAIGN.** Linked missions to create a campaign narrative.
- **MULTIPLAYER.** Create your own multiplayer session or join a multiplayer session already in progress.
- **TRAINING.** Lessons that provide step-by-step instructions in tasks such as starting the F/A-18C, takeoff and landing, navigation, or employing weapons.
- **MISSION EDITOR.** Use this very powerful tool to create your own missions.



INSTANT ACTION  
 CREATE FAST MISSION  
 MISSION  
 CAMPAIGN  
 MULTIPLAYER  
  
 LOGBOOK  
 ENCYCLOPEDIA  
 TRAINING  
 REPLAY  
  
 MISSION EDITOR  
 CAMPAIGN BUILDER  
  
 EXIT

To get started, we suggest one of the "Free Flight" INSTANT ACTION missions. Later, you can also use these missions to practice starting up the aircraft, takeoffs, landings, navigation, and sensor / weapon employment.

## Game Problems

If you encounter a problem, particularly with controls, we suggest you back up and then delete the **Saved Games\DCS\Config** folder in your home directory, which is created by DCS on your operating system drive at first launch. Restart the game and this folder will be rebuilt automatically with default settings, including all the controller input profiles.

If problems persist, we suggest consulting our [online technical support forums](#).

## Useful Links

- [DCS World homepage](#)
- [DCS: F/A-18C Forum](#)

### *Note about this manual*

(N/I). This denotes a system or function within this manual that is not implemented in DCS: F/A-18C.

# FLIGHT CONTROL

Primary aircraft flight controls include the Control Stick, Throttles, and Rudder Pedals. The stick is used to roll the aircraft left and right to perform turns, and pitch the nose up and down to climb or descend. The throttles are used to control engine power and airspeed. The pedals are used in flight to yaw the airplane left and right using the rudder (like a boat); and on the ground to turn the nose wheel when taxiing.

If you are flying with only a keyboard, the primary flight control keys will be the arrow keys to control roll and pitch, **[Numpad+]** and **[Numpad-]** to control throttle, and **[Z]** / **[X]** to control the rudder pedals. If you do have a joystick, it may be equipped with a throttle handle and/or a twist grip, which will allow you to control the rudder pedals.

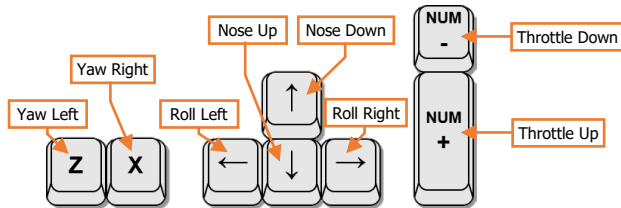

When flying from the cockpit, the Controls Indicator display may be toggled by pressing **[RCtrl]+[Enter]** to see a visual reference of the positions of your flight controls.

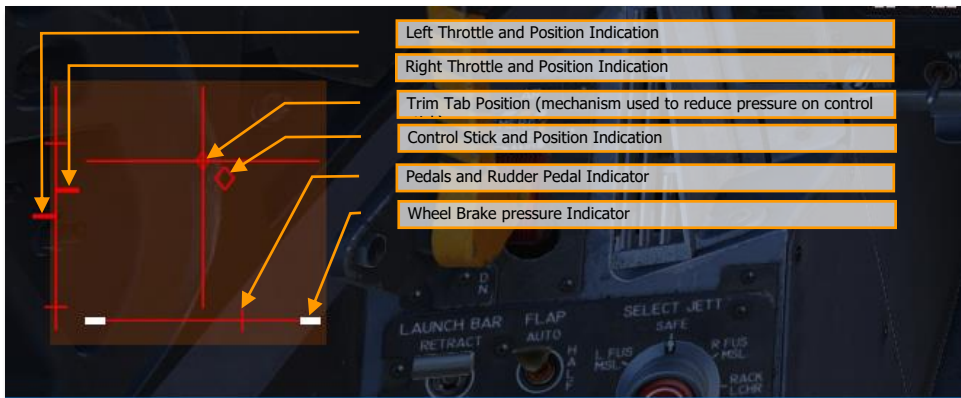

Figure 1: Controls Indicator display

## Changing Airspeed

There are several methods to increase or decrease airspeed:

- **Aircraft engine power.** When advancing the throttles, the engines will produce more thrust. Likewise, retarding the throttles will produce less thrust.
- **Aircraft pitch angle and pitch rate.** Generally, pitching the nose up above the horizon will cause the aircraft to slow down; and pitching the nose down below the horizon will cause the aircraft to speed up. Rapid pitch changes can also affect speed, regardless of whether it is a pitch change in the horizontal plane or in the vertical plane. Higher pitch rates increase the Angle-of-Attack (AoA), which increases drag, leading to a loss in airspeed.
- **Speedbrake.** Opening the speedbrake will cause an increase in drag, which can cause a loss of speed, or reduce the rate the airspeed increases while in a dive.
- **Landing Gear.** Lowering the landing gear will produce additional drag like the speedbrake, but they should only be lowered when below 300 knots to prevent damage.

The Airspeed & Velocity Scale on the HUD can be used to monitor airspeed, along with the Airspeed/Mach Indicator on the center section of the instrument panel.

## Changing Altitude

Changing the pitch of the aircraft can increase or decrease the altitude.

- **Increase altitude.** Pitching the nose up above the horizon will increase altitude, but this will cause a loss in airspeed unless engine power is increased to compensate. If the aircraft starts to stall, lower the nose and/or increase engine power.
- **Decrease altitude.** Pitching the nose down below the horizon will decrease altitude, but this will cause an increase in airspeed unless engine power is reduced to compensate. Additionally, the speedbrakes can be used to maintain current airspeed in shallow dives.

The Barometric Altitude & Altitude Scale and Radar Altimeter on the HUD can be used to monitor altitude, along with the Altimeter on the center portion of the instrument panel. Climb/descent rates can be monitored on the HUD Vertical Velocity Scale, along with the Vertical Velocity Indicator on the center instrument panel.

## Changing Heading

Changing the heading of the aircraft in the horizontal plane is accomplished by rolling, or banking, the aircraft in the desired direction. As the bank angle is increased, the stick must be pulled back in pitch to prevent a loss in altitude. At steeper bank angles, pulling back on the stick can increase the turn rate by pitching the nose in the direction of the turn. Just prior to reaching the desired heading, the stick should be used to roll the aircraft back to level flight, so that the aircraft wings return to level just as the desired heading is reached.

Note the following:

- Steep bank angles will require more pitch input to the stick to prevent altitude loss.
- During steep turns, higher pitch rates will increase the turn rate but will also increase the wings' angle-of-attack and cause the aircraft to slow down. If you lose too much speed, the aircraft may become uncontrollable. Increasing engine power or decreasing the turn rate will prevent speed loss.

- Keeping the Flight Path Marker on the Horizon Line throughout the turn will prevent altitude loss. A combination of pitch and roll inputs using the stick can be used to maintain altitude throughout the turn.

The Magnetic Heading Tape on the HUD can be used to monitor heading, which is displayed on either the top or bottom of the HUD, depending on the selected master mode. The Steering Cue shows the relative direction to your steerpoint. If you turn the aircraft to align the Flight Path Marker with the Steering Cue, you will be flying to your steerpoint.

The Electronic Horizontal Situation Indicator (EHSI) also provides the aircraft's heading. The top of the magnetic heading compass that is aligned with the lubber line at the top of instrument is the current heading.



# THE F/A-18C



# AIRCRAFT HISTORY

The McDonnell-Douglas F/A-18 was a groundbreaking aircraft from its very first flight. It holds the honors of being of the US Navy's first carrier-based true multirole fighter, the first aircraft with carbon-fiber wings, and the first fighter aircraft with a fully digital fly-by-wire flight control system. What began as the "loser" of the US Air Force's LWF program evolved into a prolific front-line fighter and attack aircraft that served the needs of the United States and seven other countries for nearly forty years.

## The VFAX Programs

In the early 1960s, the US Navy's principal concern was the fleet defense mission. The discovery of the Tu-26 "Backfire" by US intelligence caused worry among Navy admirals that the Soviet Union would soon be capable of attacking carrier fleets, launching sea-skimming cruise missiles from well outside the defensible range of the carrier.

In response to this new threat, the Navy began the VFAX program, intended to develop a long-range, highly maneuverable air superiority and fleet defense aircraft. The program mirrored the US Air Force's concurrent F-X program, which ultimately resulted in the F-15 Eagle. VFAX was intended to replace the Navy's aging fleet of fighter aircraft, especially the F-111Bs, which were seen as very lacking in the fleet defense role.



*Tupolev Tu-26 "Backfire" (credit Bernhard Gröhl)*



*Grumman F-14A Tomcat (credit PHAN Kevin Eller)*

Grumman Aerospace proposed combining its design experience with the F-111B and the A-6 Intruder to produce a new aircraft, named Design 303. The new aircraft would be built around a pair of new technologies originally developed for the F-111B: the powerful AN/AWG-9 radar and the long-range AIM-54 Phoenix missile.

The combination of the AWG-9 and AIM-54, placed in a smaller, more agile airframe, was compelling enough to convince the Navy to restructure the design requirements of the VFAX program. The result was the VFX program, which ultimately produced the F-14 Tomcat, the Navy's new frontline fleet defense and air superiority fighter.

The F-14 enjoyed immediate success as a fleet defense aircraft, but by the 1970s, it became apparent that it was too expensive and maintenance-heavy to supplant all existing Navy fighters. The Secretary of Defense, William H. Clements Jr., ordered the Navy to seek proposals for a smaller, cheaper alternative to the F-14. Grumman responded with a proposal for the F-14X, a lightweight, less expensive variant of the F-14. McDonnell-Douglas suggested navalizing the F-15. Both of those were rejected by Clements.

At the time, the only two major proponents of the lightweight multirole fighter concept were VAdm. Kent Lee, commander of Naval Air Systems Command (NAVAIR), and VAdm. William Houser, Deputy Chief Naval Officer. Though Houser and Lee had very different ideas of what a multirole fighter would look like, they were alone among the Navy brass in believing that the future of the combat aircraft was multirole capability.

Lee's motivations stemmed partially from his experience at sea, where he estimated that around fifty man-hours of maintenance effort were being expended for every one hour an aircraft spends in-flight. When Lee was selected to serve as NAVAIR's Commander, he began to advocate for a single airframe that could replace F-4s, A-7s, and A-4s. Likewise, Houser had become disillusioned with the existing Navy doctrine during his deployments, seeing firsthand the difficulty in flying and maintaining numerous types of aircraft, each with their own maintenance practices and parts requirements.

Now that the F-14 had been swept aside as a potential replacement for the Navy's fleet of fighter and strike aircraft, Lee saw an opportunity to realize his vision. After doggedly advocating his viewpoint to Clements, Clements went along with Lee's recommendation, and Lee was given the green light. The Navy then began another VFAX program under Lee's stewardship, this time with a greater emphasis on multirole capability.

Lee's opinions were still unpopular with the other admirals, which made it difficult for Lee to secure Congressional funding for the new project. Concurrent with the VFAX proposals, the US Air Force had also been looking for a lightweight fighter (LWF) to complement its expensive F-15s. The House Armed Services Committee, looking to reduce costs, ordered the Navy and Air Force to combine their efforts. Funding was diverted from VFAX into a new program, titled Navy Air Combat Fighter (NACF). NACF would be a new naval aircraft developed from the contenders already participating in the Air Force's LWF competition.



*VAdm Kent Lee (NHHC)*

## The YF-17 "Cobra"



*YF-16 and YF-17 (credit R.L. House)*

Five defense companies submitted proposals for the LWF competition, but only two were selected to participate: Northrop and General Dynamics. Northrop had already developed its popular F-5E Tiger II into an internal project titled N-300. The N-300 added distinctive leading-edge root extensions (LERX) and more powerful engines to the F-5E, among other improvements. The N-300 evolved into the P-530, which modified the design of the LERXes, giving the P-530 much improved maneuverability at high angles of attack. Northrop selected the P-530 as its LWF contender, slightly modifying it into the P-600. General Dynamics meanwhile had produced the Model 401, later designated the YF-16, and both companies were awarded contracts of approximately \$38 million to develop their proposals into functional prototypes.

International and domestic interest in the LWF program grew, and with it the stakes of the competition. In response to the ballooning demand, the USAF merged the LWF program into the new Air Combat Fighter (ACF) program. The ACF program solidified the requirement that the LWF contenders be truly multirole aircraft.

The YF-16 and YF-17 were tested by the US Air Force in a series of trial flights, and in 1975, the YF-16 was selected to be the new USAF lightweight fighter. The YF-16 had superior acceleration, climb rates, endurance, and turn rate. Its selection as the winner of the LWF competition secured it numerous procurement orders among the USAF and NATO allies.

Because the NACF program ran simultaneously with the ACF program, both General Dynamics and Northrop had also developed naval variants of their contenders. Neither firm had prior experience developing carrier aircraft. General Dynamics paired with Vought to develop the Vought Model 1600, a proposal for a strengthened, carrier-capable F-16; Northrop paired with McDonnell-Douglas to propose the F-18, a carrier-capable YF-17 variant.

Though the YF-16 had won the USAF competition, the Navy wasn't happy with its single engine and narrow landing gear. Thus, in 1975, The Navy announced its selection of the YF-17, which was to be transformed into a carrier-based multirole combat aircraft.

## Development of the F-18

McDonnell-Douglas and Northrop combined forces to develop the YF-17 into the F-18, then called Model 267. Both companies agreed to split manufacturing responsibilities evenly: McDonnell-Douglas would build the forward fuselage, wings, and stabilators; Northrop would build the center and aft fuselage components and the vertical stabilizers. Final assembly would be at McDonnell-Douglas.

The F-18 was largely similar in appearance to the YF-17 but underwent many structural and exterior changes to meet the stringent requirements of a carrier-based aircraft. The entire aircraft was strengthened to withstand the forces of carrier launch and recovery, and the undercarriage and tailhook were enlarged and fortified. The wings and stabilizers were enlarged, and the fuselage widened, and the extra size was used to boost the internal fuel capacity by 4,460 pounds, sufficient to meet US Navy blue-water reserve requirements. A fully digital fly-by-wire system with quadruple-redundant flight control computers was added, making the F-18 the first fighter aircraft with such a control system. Accessories were added to support catapult launches. In all, the modifications brought the gross weight of the F-18 to 37,000 pounds, a 10,000-pound increase over the YF-17.

Originally, the F-18 was to be developed in three variants: An F-18 fighter variant, an A-18 attack variant, and a TF-18 trainer variant. The F-18 and A-18 variants would later be combined when improvements in the avionics and weapons capability of the aircraft allowed a single variant to perform both roles effectively.

McDonnell-Douglas agreed to be the prime contractor for the naval F-18, with Northrop taking ownership of the proposed land-based F-18L export variant. The F-

18L would never come to fruition, and Northrop and McDonnell-Douglas would end their partnership on bad terms when export variants of the F-18A drew sales away from the upcoming F-18L. Northrop would later sue McDonnell-Douglas, claiming that the latter illegally used technologies developed by Northrop for the F-20 Tigershark, a lawsuit that ultimately ended in a settlement award of \$50 million paid to Northrop. In exchange, McDonnell-Douglas was free to sell the F-18, both internationally and domestically.

On September 13, 1978, the first production F-18 rolled off the assembly line. Unlike previous aircraft, which underwent flight testing at their place of manufacture, the F-18 was flight-tested at the Naval Air Test Center at Patuxent River, Maryland. Its first production flight occurred in November 1978, launching from Pax River, and flown by a US Navy-trained test pilot instead of a civilian employed by the manufacturer.



*First preproduction F-18 on display, Oct 1978 (USN)*

## F/A-18A and B Deployment



*F/A-18As aboard the USS Constellation, "Battle E" award, 1986 (USN)*

Following the completion of Navy flight testing, the F-18A and B models began appearing at fleet replacement squadrons (FRS) on both coasts. VMFA-314, based at MCAS El Toro, became the first squadron to receive the F-18 in January 1983. On April 1, 1984, the Secretary of the Navy announced that the new aircraft would be designated the F/A-18, in recognition of its multirole capability.

The F/A-18 spent a short amount of time grounded prior to its first deployment, after fatigue cracks began appearing on the vertical stabilizers. The cracks were found to be due to the turbulent airflow from the LERXes that passed across the stabilizers. The stabilizers were strengthened and the LERXes were redesigned. Years later, small fences would be placed atop each LERX, to

divert tip vortices away from the stabilizers. These changes additionally gave the F/A-18 a small boost in controllability at high angles of attack.

The F/A-18 saw its first combat deployment between February and August of 1985, aboard the USS *Constellation*. Naval aviators were pleased with its reliability in contrast to the F-14. In April 1986, F/A-18s saw action for the first time aboard the USS *Coral Sea*, on deployment off the coast of Libya for Operation Prairie Fire, with VFA-131, VFA-132, VMFA-314, and VMFA-323 aboard.

The A and B model F/A-18 was also awarded the distinct privilege of being selected as the eighth aircraft type to be flown by the US Navy's Blue Angels, replacing the A-4 Skyhawk in November 1986.

In total, more than 400 F/A-18A and B airframes were produced.

## F/A-18C and D Deployment

In 1987, development of the F/A-18C began, commencing with Lot 10. The C and D models incorporated numerous improvements, including upgraded avionics that added the ability for the F/A-18 to employ advanced, modern weapons such as the AIM-120 AMRAAM, AGM-65 Maverick, and AGM-84 Harpoon. Lot 10 also added the airborne self-protection jammer (ASPJ) and a ground-mapping synthetic aperture radar.

As with the A and B models, the F/A-18C was the single-seat variant, the D having two seats. The D model could be configured either as a training variant or as an all-weather strike craft, as used by the Marines.

In 1989, the C and D models were further upgraded with expanded night attack capability by including the AN/AAR-50 navpod, the AN/AAS-38 forward looking infrared (FLIR), the Litening II targeting pod, and night vision goggles. 1989 also saw the F/A-18 gain three full-color multipurpose displays, including adding color moving-map capability to the center AMPCD.

In 1989, during the first Gulf War, F/A-18 pilots successfully shot down two MiG-21s during a strike mission. The pilots were able to switch from the air-to-ground to air-to-air role, destroy the MiGs within 40 seconds of the E-2C's initial contact, then swap back to air-to-ground and complete their strike, cementing the credibility of the multirole concept. (You can play an Instant Action mission inspired by these events in DCS, if you own the Persian Gulf map.)

Through the 1990s, US F/A-18Cs and Ds served in Operation Southern Watch and Operation Enduring Freedom while continuing to see further technology improvements. The F404-GE-402 turbofan engine was incorporated in 1992, adding 10% more static thrust. In 1993, F/A-18's began equipping the AN/AAS-38A laser target designator/ranger (LTD/R), giving them the ability to target their own laser-guided munitions. A year later the avionics received another bump, swapping the venerable AN/APG-65 for the powerful and precise AN/APG-73 attack radar.



*F/A-18C aboard USS Kitty Hawk during Operation Enduring Freedom (credit PH3 John E. Woods)*



*F/A-18Cs fly during the retirement ceremony (USN)*

Production of the F/A-18C and D ended in August 2000. The last C model was assembled in Finland for the Finnish Air Force. F/A-18's continued to serve the US for the next two decades. The C model's last cruise was aboard the USS *Carl Vinson*, which ended in April of 2018, whereupon the Navy announced that the C models would be retired from combat duty in February 2019. The aircraft was honored with a retirement ceremony, but a few C-model F/A-18's continued to fly in training duty as aggressor aircraft, or in the service of the Blue Angels. The final flight of an F/A-18C for the US Navy was on October 2, 2019.

In all, nearly one thousand C and D model F/A-18's were produced, and C models served in the armed forces of eight countries.

Though the United States has retired the C-model F/A-18's, the model still serves in the Royal Canadian Air Force, the Finnish Air Force, the Kuwait Air Force, and the Swiss Air Force.

The US Navy has since replaced its carrier fighter fleet with the F/A-18E and F models, representing a major leap forward in the F/A-18's capability and lethality on the battlefield. Though the E and F models share the name and same basic appearance as the C and D models, they are a completely different design, with enlarged fuselage and wings, an entirely new avionics suite and cockpit, upgraded engines, and many other improvements.

There are three US Navy F/A-18C's on display in the US, with more coming as the Blue Angels transition to the F/A-18E and F models:

- BuNo 163106, painted in Blue Angels #2 livery, is at the Museum of Flight in Seattle, WA
- BuNo 163439, painted in Blue Angels #1 livery, is at the Smithsonian Air and Space Museum in Washington, DC
- BuNo 163437 is outside the Headquarters, Naval Air Force Atlantic, at Naval Station Norfolk in Virginia

# WEAPONS & MUNITIONS

## M61A1 Vulcan 20mm Cannon

The F/A-18C is equipped with an M61 Vulcan internal cannon. The M61 fires standard M50 20mm rounds at 6,000 rounds per minute. It is effective against both surface and air targets. The ammunition drum carries 510 rounds.

The M61 in DCS can be loaded with a mix of live rounds and tracers, or with live rounds only.

## AIM-9 Sidewinder

The AIM-9 Sidewinder is an infrared-guided (heat-seeking) short-range air-to-air missile. It first entered service in 1956 and has since become one of the most successful missiles in the West. Its longevity is thanks to its versatility and continued improvement over multiple generations.

The AIM-9 uses an array of up to five scanning infrared sensors, cooled by an internal argon bottle (L and M models). The Sidewinder has a maximum speed of over Mach 2.5 and a maximum range of around 10 to 20 miles, depending on the variant. Minimum range is around 3,000 feet.

The AIM-9 can be mounted directly to an LAU-127 on the wingtips, or up to two Sidewinders can be mounted to an LAU-127 mated with an LAU-115C, which adapts to the BRU-32 ejector rack, allowing the missile to be mounted to the underwing pylons.

**AIM-9L Sidewinder.** The 1977 "Lima" model was the first all-aspect Sidewinder, meaning it no longer required the target to present a rear profile. The AIM-9L earned its first kill when it struck a Libyan Su-22, after being fired from an F-14 Tomcat, in the infamous Gulf of Sidra engagement of 1981.

**AIM-9M Sidewinder.** The 1982 "Mike" model improved on the Guidance Control Section (GCS). Susceptibility to flares was reduced, and background discrimination was improved, resulting in a greater chance of lock-on. The motor's smoke signature was reduced, making the missile less likely to be detected.

**AIM-9X Sidewinder.** The 2003 "X-ray" model is the latest iteration of the Sidewinder. The X-ray adds high off-boresight (HOBS) capability and the ability to slave the seeker head to the JHMCS. The missile's maneuverability was boosted with all-axis thrust-vectoring capability. These changes allow the pilot to simply "point their head and shoot" in nearly any direction, and the missile will make its way to the target. The infrared sensor was replaced with focal-plane arrays (FPAs) and counter-countermeasures capability was improved further. Electronic fuzing was added to reduce minimum range.

**CAP-9M.** Captive variant of the AIM-9M. The captive variant has the same size, weight, and drag characteristics as the AIM-9M, for training effectiveness. It also contains an integrated infrared sensor and will provide audio and visual guidance cues to the pilot, but it does not have a motor and does not release from the aircraft.



David Monniaux (CC-BY-SA)

## AIM-120 AMRAAM

The AIM-120 AMRAAM is an active radar homing (ARH) medium-range air-to-air missile. First introduced in 1982, the AMRAAM was intended to replace the semi-active radar homing AIM-7 Sparrow, which was the medium-range BVR missile in the US inventory at the time.

The AIM-120 uses both command guidance and radar homing to reach its target. The AIM-120's integral radar has a comparatively short range, and so until the missile is within that range, it is guided by datalink commands sent automatically from the launching aircraft. The AMRAAM has a maximum speed around Mach 4 and a maximum range of 30 to 40 miles.

The AIM-120 is mounted to the LAU-127, which can be mounted in singles or pairs to LAU-115C, allowing the missile to be mounted to the underwing pylons. It can also be mounted directly to stations 4 and 6.

**AIM-120B AMRAAM.** This 1994 variant is the earliest variant still in production.

**AIM-120C AMRAAM.** The 1996 variant improved target detection, homing capability, and fuzing.



*SCDBob (CC-SA)*

## AIM-7 Sparrow

The AIM-7 Sparrow is a semi-active medium-range air-to-air missile. Development on the Sparrow first began in 1949, when it was originally conceived as a beamrider. The AAM-N-2 Sparrow I, this beam-rider variant, entered service in 1954. Later prototypes were active radar-guided, but the first Sparrow to enter widespread production was the AAM-N-6 Sparrow III (later renamed the AIM-7C). The AIM-7E saw extensive use in Vietnam, where 612 were fired, resulting in 56 kills.



*CMDR John Leenhouts (USN)*

The modern AIM-7 has a maximum speed of Mach 4 and an operational range of up to 53 nautical miles, though performance will depend on the intensity of the radar energy reflected from the target. As a semi-active guided missile, the launching aircraft must maintain a continuous radar lock on the target until impact.

The AIM-7 is mounted to the LAU-115C connected to underwing pylons.

**AIM-7F Sparrow.** The 1976 variant had improved range thanks to a dual-stage rocket motor, solid-state electronics, and a larger warhead than the E model.

**AIM-7M Sparrow.** The most common variant today, the M was first introduced in 1982 and used extensively during the First Gulf War. Tracking reliability was greatly improved with the use of an inverse monopulse radar. It also added active-radar proximity fuzing, better ECCM, and better performance at low altitudes.

**AIM-7MH Sparrow.** This is the AIM-7M variant with a newer software version (the H build). The upgraded software improves guidance and loft performance.



## AGM-154 Joint Standoff Weapon (JSOW)

The AGM-154 is the result of a combined Navy/Air Force venture to produce a precision-guided glide bomb, first introduced in 1988 and first employed during Operation Desert Fox. The AGM-154 uses an INS/GPS guidance system to navigate to its target. The bomb is unpowered, but the extending glide fins give it a range of around 70 nautical miles when dropped from high altitudes. The bomb weighs around 1,000 pounds.

The AGM-154 development program is widely considered to be one of the best successes in project management in the defense industry. The program is often used as an example in the industry and in academia.



*PHAN Jose Cordero (USN)*

**AGM-154A.** The baseline JSOW has a warhead containing 145 BLU-97/B combined effects submunitions. The submunitions have anti-armor, anti-materiel, and anti-personnel effects. The AGM-154A is typically used as a SEAD weapon.

**AGM-154C.** The unitary variant contains an infrared seeker used during the terminal phase and the penetrating BROACH warhead. The BROACH warhead is a two-stage system designed for penetrating hardened bunkers. It consists of the WDU-44 shaped augmenting warhead and the WDU-45 follow-through bomb. The WDU-44 penetrates the armor layer, and the WDU-45 detonates within the interior chambers, amplifying its concussive effects.

## AGM-84 Harpoon, SLAM, and SLAM-ER

The **AGM-84D** Harpoon is a turbojet-powered sea-skimming anti-ship missile with over-the-horizon attack capability. The Harpoon uses INS mid-course guidance, then locates and guides to its target using terminal attack radar. It then performs a terminal pop-up maneuver just prior to impact. The missile sea-skims at around Mach 0.7 and contains a 500-pound warhead with impact fuzing. The missile weighs 1,500 pounds.

The **AGM-84E** Standoff Land Attack Missile (SLAM) is a land attack variant developed from the Harpoon. The SLAM enhances the INS midcourse guidance with GPS updates, adds infrared-homing terminal guidance and the capability for datalinked seeker head video and datalinked command guidance, and increases the warhead size to 1,000 pounds.



*Combined Military Service Digital Photographic Files*

Both variants have a range more than 60 nautical miles.

The **AGM-84K** SLAM Extended Response (SLAM-ER) is an improvement over the SLAM that greatly improves its range to around 150 nautical miles and adds improved terminal guidance capabilities.

## AGM-88 HARM

The AGM-88 High-speed Anti-Radiation Missile (HARM) is a passive radar homing air-to-ground missile used in the suppression of enemy air defenses (SEAD) role. The HARM has a radar receiver and processor that detects and identifies signals from enemy surface radars. When launched, it can guide to the target by homing on its specific radar emissions. The missile also has an inertial guidance system to provide mid-course guidance prior to detection of the radar signal (or if the signal is lost).

The AGM-88 has a maximum speed of Mach 1.84 and an operational range of around 80 nautical miles. It uses a laser proximity fuze for detonation.

**AGM-88C.** This mid-1980s variant incorporates field-reprogrammable software and improved guidance and fuzing.



*SSGT Scott Stewart (USAF)*

## AGM-65 Maverick

The AGM-65 Maverick is a medium-range air-to-ground missile designed for the close air support role. The AGM-65 family contains a diverse set of variants and guidance systems, including infrared, electro-optical, and laser guidance.

The AGM-65 has a maximum range of around 13 nautical miles. It was first delivered in 1972. A single Maverick can be mounted to an LAU-117 rack.

**AGM-65E Maverick.** The E model uses laser guidance, either from the F/A-18C's onboard designator or from another laser emitter. It has a 300-lb penetrating warhead with a delayed fuze.

**AGM-65F Maverick.** The F model uses an infrared tracking system adapted for the anti-ship role. It has the same warhead as the Maverick E.



*SSGT Glenn B. Lindsey (USAF)*

## AGM-62 Walleye II

The AGM-62 Walleye II is a television-guided glide bomb dating back to 1963 and used principally during the Vietnam War. The original AGM-62 models used image centroid tracking like electro-optical Mavericks; newer models also added datalinked video and command guidance capability.

The AGM-62 has a 2,000-lb high-explosive warhead. Despite being designated "AGM," the AGM-62 is an unpowered glide bomb.



*Combined Military Service Digital Photographic Files*

## Mk. 20 Rockeye and CBU-99

The Mk. 20 Rockeye is a 500-lb anti-tank cluster bomb that carries 247 Mk. 118 Mod 1 bomblets. Each bomblet contains a shaped charge capable of penetrating several inches of armor. Rockeyes were used extensively during Operation Desert Storm to attrit Iraqi tank battalions. The Mk. 20 and CBU-99 are unguided free-fall bombs.

**Mk. 20 Rockeye.** The baseline variant is used for shore-based operations.

**CBU-99.** This variant has increased thermal protection and is used for shipboard operations.

The Rockeye can be mounted in pairs on a BRU-33 rack.



*Combined Military Service Digital Photographic Files*

## Paveway II Laser Guided Bomb

The Paveway II is a series of laser-guided bombs based on conventional general-purpose bombs. The guidance kit consists of a laser detector and processor in the front and a set of steering fins in the back. The bomb detects and tracks reflected laser energy off a target. The laser designation can come from the launching aircraft, another aircraft ("buddy lasing"), or from a laser-capable ground unit such as a JTAC.

The Paveway II series was introduced in the early 1970s to replace the first-generation Paveway series of laser-guided bombs. The Paveway II improved sensor reliability and added extendible rear fins to extend glide range. The Paveway II series uses "bang-bang" control (where the fins can only deflect fully in either direction), limiting its maximum range and forcing it to follow a sinusoidal path to the target.



*SSGT Glenn B. Lindsey (USAF)*

**GBU-12.** Paveway II bomb based on the Mk. 82, a 500-pound conventional bomb. The GBU-12 can be mounted in pairs using a BRU-33 rack.

**GBU-16.** Paveway II bomb based on the Mk. 83, a 1,000-pound conventional bomb.

**GBU-10.** Paveway II bomb based on the Mk. 84, a 2,000-pound conventional bomb.

## Paveway III Laser Guided Bomb

The Paveway III series of laser-guided bombs was introduced in 1983. The series added the ability for the fins to move continuously, increasing glide efficiency. Paveway III technology also introduced improved avionics, including launch acceptability region calculations and configurable attack headings.

**GBU-24.** Paveway III bomb based on the Mk. 84, a 2,000-pound conventional bomb.

## Joint Direct Attack Munition (JDAM)

JDAM is a kit that modifies a Mk. 80-series conventional bomb, giving it precision INS/GPS guidance capability. The JDAM kit consists of a GPS receiver, integral INS, and steerable fins. JDAM bombs must downlink target coordinates prior to release and cannot be manually steered or re-targeted after release. Modern JDAM kits have a precision of around 25 feet circular error probable (CEP).

The Joint Direct Attack Munition program began after Operation Desert Storm, when the US Air Force sought a weapon that could guide more reliably than an LGB in adverse weather such as dust storms. After extensive testing, the concept of an INS/GPS-guided bomb was shown to be effective by 1993, and the first JDAM kits were delivered to operational squadrons in 1997.



*MC2 Milosz Reterski (USN)*

**GBU-38.** JDAM guidance kit installed on a Mk. 82 500-pound conventional bomb. Up to two can be mounted on a BRU-55.

**GBU-32(V)2/B.** JDAM guidance kit installed on a Mk. 83 1,000-pound conventional bomb.

**GBU-31(V)1/B.** JDAM guidance kit installed on a Mk. 84 2,000-pound conventional bomb. USAF variant.

**GBU-31(V)2/B.** JDAM guidance kit installed on a Mk. 84 2,000-pound conventional bomb. USN variant.

**GBU-31(V)3/B.** JDAM guidance kit installed on a BLU-109, a 500-pound hardened penetrating bomb. USAF variant.

**GBU-31(V)4/B.** JDAM guidance kit installed on a BLU-109, a 500-pound hardened penetrating bomb. USN variant.

## Mark 80-Series General-Purpose Bomb

The Mk. 80-series of general-purpose bombs is a series of unguided bombs dating back to the Vietnam War. The bombs come in nominal weights of 500, 1,000, and 2,000 pounds. The bombs are very versatile, and they can be fitted with both nose and tail fuzes, as well as different guidance kits.

The Mk. 82 and Mk. 83 variants can be mounted in singles or pairs on a BRU-33 rack.

**Mk. 82.** A general-purpose bomb with a nominal weight of 500 pounds.

**Mk.82 Snakeye.** A Mk. 82 with retarding petals that extend after release. The petals reduce the bomb's downrange speed after release, allowing aircraft to perform low-level straight-through deliveries at lower altitudes without risk of frag damage.

**Mk. 82Y.** A Mk. 82 with a BSU-49 Air Inflatable Retarder (AIR). The AIR is a ballute that expands after release, performing the same retarding function as the Snakeye. The AIR is a newer technology and is more effective than the Snakeye, making the bomb safe to use at higher speeds than the Snakeye.

**Mk. 83.** A general-purpose bomb with a nominal weight of 1,000 pounds.

**Mk. 84.** A general-purpose bomb with a nominal weight of 2,000 pounds.



*SSGT Randy Mallard (USAF)*

## Rockets

The F/A-18C can equip a variety of different rocket pods that can fire 2.75-inch FFARs or 5-inch Zuni rockets. These pods are mounted on BRU-33 racks in singles or pairs.

**LAU-10.** The LAU-10 launcher can carry up to four 5-inch Zuni rockets.

**LAU-61.** The LAU-61 can load up to 19 2.75-inch FFARs.

**LA-68.** The LAU-68 can load up to 7 2.75-inch FFARs.

**Zuni Mk. 71.** The Mk. 71 Zuni rocket has a higher-thrust, longer-burning motor. The Mk. 71 is equipped with a high-explosive warhead. The Zuni rocket dates back to 1957, and was used extensively in the Vietnam War. It has a modular design and can accommodate different motors, warheads, and fuzes.

**M151 HE.** A Hydra 70 FFAR with an M151 high-explosive warhead, effective against personnel and light vehicles.

**Mk. 5.** A Hydra 70 FFAR with a Mk. 5 high-explosive anti-tank (HEAT) warhead, effective against armor with direct hits, and secondary blast effects for nearby personnel and light vehicles.

## Fuel Tanks

External fuel tanks carry additional fuel to increase the F/A-18C's range and combat radius. Like most munitions, the fuel tanks are capable of being jettisoned when needed. The external tanks can be refueled during air-to-air refueling. The weight of the tank depends on the amount of fuel carried.

**FPU-8/A.** External fuel tank with a capacity of 330 gallons (approximately 2,200 pounds).



*MCSA Figueroa Medina (USN)*

## AN/ASQ-228 ATFLIR

The Advanced Targeting Forward Looking Infrared (ATFLIR) pod is an electro-optical TV and infrared targeting pod with laser target designation capability. It includes a steerable camera with a wide zoom range, capable of daylight and nighttime target detection and laser designation.

(For more information, see [Advanced Targeting Forward-Looking Infrared](#) (ATFLIR) chapter).

## AN/AAQ-28 Litening II Targeting Pod

The AN/AAQ-28 Litening II is an electro-optical and infrared targeting pod with target designation capability. It includes a steerable camera with a wide zoom range, capable of daylight and nighttime target detection and laser designation.

(For more information, see [Litening II Targeting Pod](#) chapter)

## AN/AWW-13 Advanced Datalink

The AN/AWW-13 is used to receive post-launch video from, and send guidance commands to, the AGM-62 Walleye, AGM-84E SLAM, and AGM-84K SLAM-ER.

## AN/ASQ-T50 TCTS Pod

The AN/ASQ-T50 is a Tactical Combat Training System (TCTS) pod. It incorporates a sensor platform and datalink transceiver, allowing it to record and transmit real-time aircraft telemetry to monitoring stations. TCTS pods are used during training exercises to monitor and record aircraft positions, for many purposes, including debriefing analysis.

The TCTS pod is captive and cannot be released. It can be mounted to either outboard wingtip station.

## Training Bombs

Training bombs are inert, releasable munitions with the same ballistic properties as combat stores. Upon impact, these bombs can release a smoke cloud that can be used to identify the impact point.

**BDU-33.** Inert training bomb simulating the weight and ballistic characteristics of the Mk. 82. The BDU-33 is loaded in groups of six on a BRU-41A rack.

**BDU-45.** Inert training bomb simulating the weight and ballistic characteristics of the Mk. 82 Snakeye. The BDU-45 provides Mk. 82-specific training for both pilots and ordnancemen.

**BDU-45/B.** Inert training bomb simulating the weight and ballistic characteristics of the Mk. 82. Unlike the BDU-33, the BDU-45/B also matches the shape and size of the Mk. 82, meaning it can only be loaded in singles or pairs.



*Combined Military Service Digital Photographic Files*

# COCKPIT OVERVIEW

Once in the cockpit, it's best to have a general understanding of where the various controls are located. To help locate items more easily, we have broken the cockpit into eight primary areas. In later sections of this guide, we will reference these locations.

## Instant Action Mission Practice: Cold and Dark

F/A-18C Instant Action Mission: Cold and Dark. Use this mission to explore the cockpit and become familiar with its layout. To move your view:

- **[Keypad 8]**: Up
- **[Keypad 6]**: Right
- **[Keypad 2]**: Down
- **[Keypad 4]**: Left
- **[Keypad \*]**: Zoom In
- **[Keypad /]**: Zoom Out

Pressing **[LAlt]+[C]** toggles mouse control between interacting with the cockpit and controlling your view.

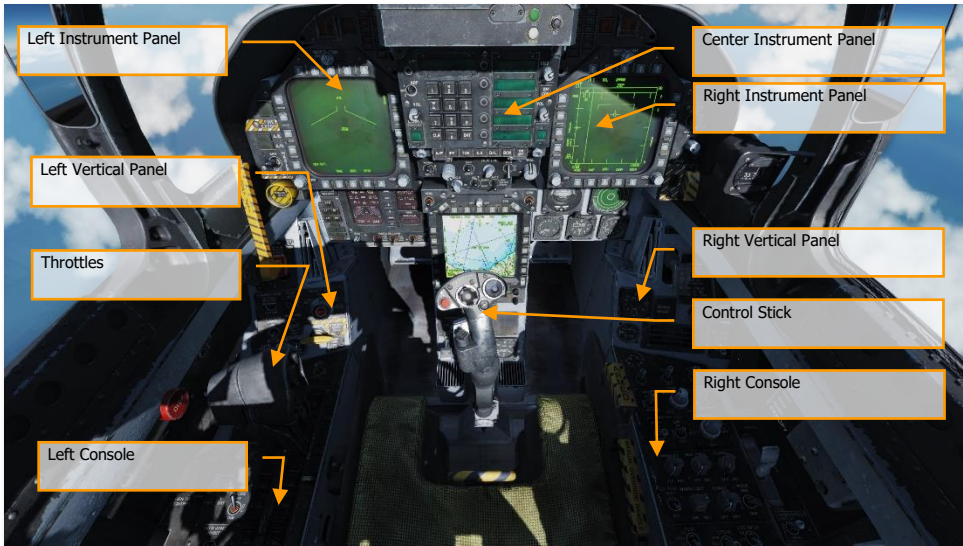

Figure 2. F/A-18C Cockpit Overview

## Left Instrument Panel

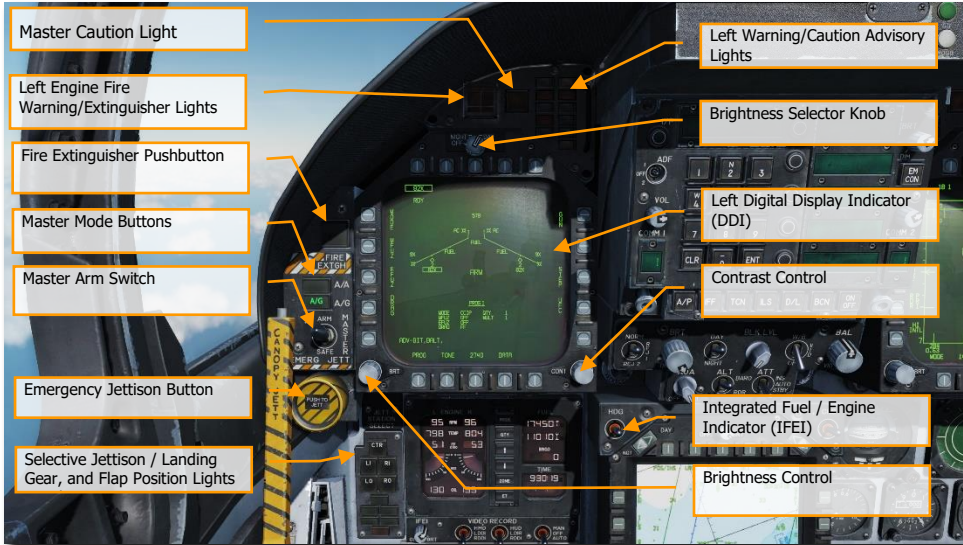

Figure 3. Left Instrument Panel

### Left Digital Display Indicator (DDI)

The left DDI is a 3-color (green, yellow, and red) display that provides desired information to control various aircraft functions and displays. There are 20 pushbuttons (PB) on the DDI which are used to select the function and the mode for proper indicator display. PB 1 is the lowest button on the left side, and then each PB button is numbered sequentially in a clockwise manner.

### Brightness Selector Knob

Placing this rotary knob to OFF prevents the DDI from operating. Placing the knob to NIGHT provides a lower brightness control range, and the DAY setting provides a brighter default setting.

### Brightness Control

This knob varies the intensity of the symbols and text. Rotate clockwise to increase brightness and counterclockwise to decrease brightness.

### Contrast Control

This knob varies the contrast between symbology and the dark background on any level of brightness. (N/I)



## *Master Mode Buttons*

These two buttons allow you to change between Air-to-Air (A/A) [1] and Air-to-Ground (A/G) [2] master modes. There are three master modes of operation: navigation (NAV), air-to-air (A/A), and air-to-ground (A/G). The controls, displays, and the avionic equipment operation are tailored as a function of the master mode you select. The navigation master mode is entered automatically when power is applied to the aircraft, when the air-to-air or air-to-ground modes are deselected, when the landing gear is lowered, when the SPIN mode activates, or when the aircraft has weight on wheels and the throttle position (power lever angle) is greater than 56°. The A/A master mode is entered either by pressing the A/A master mode button or by selecting an A/A weapon with the A/A weapon select switch on the control stick. The A/G master mode is selected by pressing the A/G master mode button. The selection is performed by the Stores Management Set (SMS), and the SMS identifies the selected master mode to the mission computer.

## *Master Arm Switch [M]*

This switch controls the ability for weapons to be employed or jettisoned. Weapons can only be released when this switch is set to the ARM position.

## *Emergency Jettison Button*

The emergency jettison button, labeled EMERG JETT jettisons stores from the parent bomb racks on external stores stations 2, 3, 5, 7 and 8. Holding the button down for 375 msec initiates jettison.

## *Selective Jettison / Landing Gear, and Flap Position Lights Panel*

This panel has three primary functions; the top is used to selectively select stations to jettison and the bottom two provide landing gear and flaps status.

**Station Jettison Select Buttons.** Selective jettison is performed by the selective jettison knob in conjunction with the station jettison select buttons. The station jettison select buttons are used to select which weapon station or stations will be jettisoned. The selective jettison knob is used to select jettison of either the stores or the stores and launchers/racks on the weapon stations selected by the station jettison select buttons. After station and store/launcher/rack selection, jettison is performed by pressing the JETT center pushbutton in the selective jettison knob. In addition, the selective jettison knob can jettison the right or left fuselage Sparrow or AMRAAM missile by selecting R FUS, MSL or L FUS MSL and pressing the JETT center pushbutton. Selective jettison can only be performed with the landing gear up and locked with the master arm switch in ARM and jettisons the stores in a safe condition.

The station jettison select buttons are on the left edge of the instrument panel below the emergency jettison button. The buttons are labeled CTR (center), LI (left inboard), RI (right inboard), LO (left outboard) and RO (right outboard). Pressing a button illuminates an internal light and selects a weapon station for jettison. The station jettison select buttons are also used in the backup A/G weapon delivery modes for weapon selection.

**Landing Gear Indications.** There are three green landing gear position lights marked NOSE, LEFT and RIGHT. The lights indicate that the gear is down and locked, or that a gear link is not locked.

**Flap Indications.** A green light indicates the aircraft is within flight parameters for the flight control computer to adjust flap scheduling in accordance with the selected switch position.

- **HALF.** FLAP switch at HALF setting and airspeed below 250 knots.
- **FULL.** FLAP switch at FULL setting and airspeed below 250 knots.

- **FLAPS.** FLAP switch HALF or FULL settings and airspeed over 250 knots, abnormal flap condition (any flap is off or lacks hydraulic pressure), in spin recovery mode, or GAIN switch in ORIDE position.

### *Integrated Fuel / Engine Indicator (IFEI)*

The integrated fuel/engine indicator (IFEI) engine display contains a left and right liquid crystal display for RPM (N2)%, TEMP (EGT)°C, FF (fuel flow) PPH, NOZ (nozzle position)%, and OIL (oil pressure) psi. During engine starts without external electrical power, only RPM and TEMP are displayed by battery power until the APU comes online. With the APU online or external power, all engine data is displayed.

**Engine RPM.** Displays engine N2 rpm from 0 to 100%. There is no RPM indication of afterburner.

**Exhaust Gas Temperature (TEMP).** Displays turbine exhaust gas temperature (EGT) from 0 to 1,999°C.

**Engine Fuel Flow (FF).** Displays main engine fuel flow only (afterburner fuel flow is not displayed). Range is from 3 (300 PPH) to 199 (19,900 PPH) Pounds Per Hour in 100 pound per hour increments. However, when fuel flow is less than 320 PPH, 0 is displayed.

**Engine Nozzle Position (NOZ).** Displays exhaust nozzle position from 0 to 100% open in 10% increments.

**Engine Oil Pressure (OIL).** Displays engine oil pressure from 0 to 195 psi in 5 psi increments.

The IFEI fuel display window contains three digital counters to provide dynamic fuel quantity indications. The upper digital counter displays total aircraft fuel quantity (10-pound increments). The middle digital counter displays total internal fuel quantity (10-pound increments). A digital counter legend is displayed to the right of the upper and middle counters (T - total fuel, I - internal fuel). The lower digital counter displays the selected BINGO fuel quantity (100-pound increments).

**BINGO.** The Bingo fuel setting can be set by pressing the up and down arrows in the center of the IFEI. The value in pounds will then be displayed in the Bingo Fuel field and be used to trigger Bingo fuel caution messages and audio alerts.

Bingo fuel is only editable when the total (T) and internal (I) fuel quantities are shown.

**MODE Button.** Pressing the MODE button in the center of the IFEI. Two presses of the button allow you to set the day and time. Use the QTY button to cycle between editing of Hour (H), Minute (M), time offset (D), and Year (Y). Upon selection of each, use the up and down arrows on the IFEI to adjust the value.

**QTY Button.** Cycles IFEI display between different fuel tank quantities. A legend is displayed next to the quantity:

1. Total (T) and Internal (I). This is the normal display.
2. Left Feed Tank #2 (FL) and Right Feed Tank #3 (FR)
3. Left Transfer Tank #1 (TL) and Right Transfer Tank #4 (TR)
4. Left Wing Tank (WL) and Right Wing Tank (WR)
5. Left External Tank (XL) and Right External Tank (XR)
6. Centerline Tank (C)

When the quantity display is set to anything other than total + internal, the Bingo display instead displays total fuel quantity.

**ZONE Button.** Press the ZONE button on the IFEI to toggle the TIME to display local or ZULU (Z) time.

**Elapsed Time (ET) Button.** Press once on the ET button to start an elapsed time timer that will count in seconds. A second presses pauses the timer. A third presses resumes. By holding down the button, the timer will reset to zero.

**IFEI Brightness Knob.** In the bottom left corner of the IFEI panel is the IFEI Brightness (BRT) knob. This is used to control the brightness of the display in the internal lighting panel mode switch is set to NITE or NVG. It has no effect in the DAY setting.



Figure 4. Integrated Fuel / Engine Indicator (IFEI)

### Left Engine Fire Warning/Extinguisher Lights

If a fire is detected in the left engine, this indicator, marked FIRE, will be lit along with an “Engine Fire Left, Engine Fire Left” audio warning. This is a steady state, red light. To enable the fire bottle to discharge into the selected engine/AMAD bay, the pilot must lift the guard over the FIRE warning light and press the FIRE button. The button has two positions. Pushed in shuts off fuel flow to the engine and arms the fire extinguisher and the READY light will illuminate. Pushing this FIRE Warning button in once more toggles the button to the out position and the fuel valve will open again for that engine and the READY light will turn off.

### Master Caution Light

A yellow MASTER CAUTION light, on the upper left part of the instrument panel, comes on when any of the caution lights or caution displays come on. The MASTER CAUTION light goes out when it is pressed (reset). An audio tone is initiated whenever the MASTER CAUTION light comes on. This button is also used to “re-stack” caution and advisory notices.

### Left Warning/Caution Advisory Lights

The Left Warning/Caution Advisory Lights provide visual indications of normal aircraft operation and system malfunctions affecting safe operation of the aircraft. A red warning light normally indicates a system malfunction that could be a severe hazard to further flight and may require immediate action. Yellow caution lights and displays normally, but not always, indicate malfunctions that require attention but not immediate action. After the malfunction has been corrected, warning and caution lights and caution displays go out. Advisory lights and displays indicate safe or normal conditions and supply information for routine purposes.

**L BLEED.** Will light when the Fire and Bleed Air Test Switch is pressed, or bleed air leak or fire (600 °F) has been detected in the left engine bleed air ducting. If illuminated, the left bleed valve is automatically closed. Will light when TEST A or TEST B switch is held, or a bleed air leak or fire has been detected in the left engine ducting. A “Bleed Air Left, Bleed Air Left” audio message will also sound. L BLD OFF caution will be displayed on the LDDI.

**R BLEED.** Will light when the Fire and Bleed Air Test Switch is pressed, or bleed air leak or fire (600 °F) has been detected in the right engine bleed air ducting. If illuminated, the right bleed valve is automatically closed. Will light when TEST A or TEST B switch is held, or a bleed air leak or fire has been detected in the right engine ducting. A "Bleed Air Right, Bleed Air Right" audio message will also sound. R BLD OFF caution will be displayed on the LDDI.

**SPD BRK.** Will light anytime the speed brake is not fully retracted.

**STBY.** When ALQ-165 ECM mode switch is set to STBY on the ECM control panel, the STBY light indicates that the ECM Jammer is in warm up mode. This will last five minutes and then time out and extinguish.

**L BAR (Red).** Launch bar malfunction. Nose gear cannot retract. The launch bar can only be extended with weight on wheels.

**L BAR (Green).** Launch bar extended with weight on wheels. Will extinguish when the launch bar switch is in the UP position (catapult shuttle holds the launch bar in the extend position until the end of the catapult stroke).

**REC.** Indicates that the aircraft is being illuminated by a threat radar.

**XMIT.** Lit when ECM Jammer is transmitting.

**GO.** Indication of successful BIT of ALQ-165. Will remain illuminated until BIT mode is deselected.

**NO GO.** Indication of unsuccessful BIT of ALQ-165. Will remain illuminated until BIT mode is deselected. ALQ-126 is inoperable.

### *Fire Extinguisher Pushbutton*

This switch has two lights: a yellow light labeled READY, and a green light labeled DISCH (discharge). When READY is on, the fire extinguisher bottle is armed. The READY light comes on when the appropriate fire warning/extinguisher light is lit. Pressing an engine fire warning/extinguisher light shuts off fuel to the engine at the feed tank. With READY on, pressing the fire extinguisher pushbutton discharges the fire extinguisher bottle and turns on the DISCH light.

## Center Instrument Panel



Figure 5. Center Instrument Panel

## Heads-Up Display (HUD)

The HUD is used as the primary flight instruments, weapon status, and weapon delivery display for the aircraft under all selected conditions. The HUD receives attack, navigation, situation, and steering control information from the left or right DDI symbol generators (under mission computer control), and projects symbology on the combining glass for head-up viewing. The HUD will be discussed in much greater detail later in this guide.

### Angle of Attack Indexer Lights

The AOA indexer is mounted to the left of the HUD. It displays approach angle of attack (AoA) with lighted symbols. Corresponding AOA indications are shown on the HUD. The indexer only operates with the landing gear down, Weight-off-Wheels, a valid Air Data Computer (ADC) AOA signal and a functional ADC. The lighted symbol(s) flash if the arresting hook is up and the Hook Bypass Switch, on the left vertical panel, is in CARRIER. The symbols do not flash with the arresting hook up and the hook bypass switch in FIELD. The switch is solenoid held to FIELD and automatically goes to CARRIER when the arresting hook is lowered, or aircraft power is removed. The AOA Indexer Knob on the HUD control panel dims the symbols.

With Weight on Wheels (WoW), the indexer lights do not operate.

SYMBOL	AIRSPEED	AOA
	Slow	9.3° to 9.0°

	Slightly slow	8.8° to 9.3°
	On speed	7.4° to 8.8°
	Slightly fast	6.9° to 7.4°
	Fast	0° to 6.9°

### Upfront Controller (UFC)

The UFC is on the main instrument panel below the HUD. The UFC is used to select the autopilot, ILS, datalink, and radios. The UFC is used in conjunction with the two DDIs and the AMPCD to enter navigation, sensor, and weapon delivery data.



Figure 6. Up-Front Controller

1. **Scratchpad Window.** The scratchpad window displays keyboard entries on a nine-character readout. The first two characters are alphanumeric and the other seven are numeric.
2. **Automatic Direction Finding (ADF) Function Select Switch.** This is a three-place switch that allows the pilot to set ADF navigation based on the COMM 1 radio by setting the switch to 1, or COMM 2 by setting the switch to 2. Placing the switch in the center, OFF position disables ADF navigation. See the Automatic Direction Finder (ADF) Navigation chapter for greater detail.
3. **COMM 1 Volume Control.** Turning the volume control to the OFF position turns off the COMM 1 radio. Out of the OFF position, the knob controls the audio volume for the corresponding COMM 1 radio.
4. **COMM 1 Channel Display.** The COMM 1 channel display window displays the channel of the COMM 1 radio.
5. **COMM 1 Channel Selector.** Rotating the knob with the mouse wheel selects channel 1 through 20, manual (M), guard (G), cue channel (C), or maritime channel (M). The channel is displayed in the corresponding COMM 1 channel display window. Pulling the spring-loaded knob (a right mouse click) causes the selected channel and its frequency to be displayed in the scratchpad and enables the control converter to change the frequency of the selected channel via the keyboard entry.
6. **COMM 2 Volume Control.** Turning the volume control to the OFF position turns off the COMM 2 radio. Out of the OFF position, the knob controls the audio volume for the corresponding COMM 2 radio.
7. **COMM 2 Channel Display.** The COMM 2 channel display window displays the channel of the COMM 2 radio.
8. **COMM 2 Channel Selector.** Rotating the knob with the mouse wheel selects channel 1 through 20, manual (M), guard (G), cue channel (C), or maritime channel (M). The channel is displayed in the corresponding COMM 2 channel display window. Pulling the spring-loaded knob with a right mouse click causes the selected channel and its frequency to be displayed in the scratchpad and enables the control converter to change the frequency of the selected channel via the keyboard entry.
9. **EMCON Pushbutton.** Pushing the button inhibits radar, radar altimeter, datalink, and Walleye from transmitting. The letters E, M, C, O, and N are displayed in a vertical column in the five option windows when EMCON is selected. Pushing the button again permits the transmitters to radiate. Currently no function.
10. **Brightness Control Knob.** The knob has positions of BRT (bright) and DIM. The brightness of the Option Display Windows and Scratchpad Window increases as the knob is rotated clockwise toward BRT.
11. **Option Select Pushbuttons.** The five pushbuttons select or deselect the displayed options.
12. **Option Display Windows.** The option display windows display five options of four alphanumeric characters each that are available for selection.
13. **Pushbutton Keyboard.** The pushbutton keyboard contains alphanumeric pushbuttons, a CLR (clear) pushbutton, and an ENT (enter) pushbutton. Pressing the alphanumeric pushbutton enters a corresponding alphanumeric as digital information into the control converter. The number or letter of

the pressed button is displayed on the right end of the scratchpad. The number or letter moves to the left as additional numbers are entered. The decimal point or degree/minute symbols are automatically displayed in correct position for information being entered. Trailing zeroes must be entered. Pressing the CLR pushbutton clears the scratchpad and/or the option display windows. Pressing the CLR pushbutton once clears the scratchpad, pressing it a second time clears the option display windows. Pressing the ENT pushbutton causes the keyboard entry displayed in the scratchpad to be sent to the control converter to change operation of selected equipment or to make data available to the mission computer. If entry via the keyboard is valid, the scratchpad display blinks once. If entry is invalid, ERROR appears and flashes in the scratchpad display until the scratchpad is cleared.



Figure 7. UFC Function Buttons

**Function Selector Push buttons.** The function selector pushbuttons as pictured above are all mutually exclusive. When a function selector pushbutton is pressed, the control options for that equipment are displayed in the Option Windows. The autopilot button displays the selected autopilot mode options in the option windows and the desired mode/modes are colonized (prefaced with a colon). Note that pressing the autopilot button will not engage autopilot! When the equipment is on, the word ON is displayed in the first two alphanumeric of the scratchpads. The first two alphanumeric are blank when the equipment is off. Pressing the function selector pushbutton, a second time clears the UFC display. The pressing of a function selector pushbutton, the pulling of a channel selector knob, or the receipt of a UFC mode command from the mission computer terminates all prior activity, with all previous entries retained, and presents the options for the newly selected mode.

**Autopilot Pushbutton (AP).** The automatic flight control system (autopilot) has two basic modes: pilot relief and datalink. The pilot relief mode consists of heading hold, heading select, attitude hold, barometric altitude hold, and radar altitude hold. Control of the automatic flight control modes is accomplished by the switches on the up-front control (UFC), heading set switches on the heading and course set switches panel, and the autopilot disengage/nosewheel steering switch on the control stick. Before any mode can be selected bank must be less than or equal to 70°, pitch must be less than or equal to 45°, and the A/P pushbutton must be pressed. Selection of the A/P pushbutton displays the pilot relief options of: ATTH (attitude hold), HSEL (heading select), BALT (barometric altitude hold), and RALT (radar altitude hold) the UFC option display windows. When a pilot relief option is selected via the UFC a colon (:) appears in front of the selected display and the selected mode appears on the DDI advisory display. If an option is not available, it is not displayed.

Pressing the A/P button displays the autopilot options, and the desired mode is colonized by pressing the Option Select Button next to the desired mode. Decolonizing will disconnect the autopilot, as will actuating the autopilot disconnect paddle on the stick.

**ATTH:** Attitude hold mode is selected. Attitude hold is engaged by pressing the option pushbutton next to the option display window displaying ATTH. Engagement is indicated by a colon in the ATTH option window. Currently the aircraft maintains the existing pitch and roll attitude.

**BALT:** Barometric altitude hold mode is selected. To establish barometric altitude hold, press the button next to the option display window displaying BALT. The existing barometric altitude at time of engagement is captured and maintained. Heading or attitude hold is maintained, depending upon which mode was previously engaged. The operating range is 0 to 70,000 feet. ATTH or HSEL can be selected with BALT to provide lateral control.



**HSEL:** Heading select mode is selected. To establish heading select mode, select the desired heading on the HSI display by using the heading set switch, located to the left of the center DDI. Press the button next to the option display window displaying HSEL. The aircraft turns from existing heading through the smallest angle to the selected heading. Heading hold is reestablished after the selected heading is captured. Existing pitch attitude is maintained.

**RALT:** Radar altitude hold mode is selected. To establish radar altitude hold, press the pushbutton next to the option display window displaying RALT. Engagement is indicated by a colon appearing in the window next to RALT. The existing radar altitude is maintained upon engagement. Radar altitude hold coverage is from 0 to 5,000 feet. If no other mode is selected, the lateral axis control remains in heading hold. In this configuration, roll trim switch can be utilized with automatic turn coordination up to 45° with altitude maintained. ATTH or HSEL can be selected with RALT to provide lateral control.

**CPL.** Coupled mode is selected. See Using Coupled Autopilot Mode.

**TCN Pushbutton (TCN).** To enable the TACAN system press the TCN pushbutton. This allows the TACAN code and ON/OFF status to be displayed on the UFC scratchpad, along with the TACAN mode options on the UFC Option Windows. These include:

- T/R: Transmit / Receive.
- RCV: Receive
- A/A: Air-to-Air
- X: X Band
- Y: Y Band

Now you can actuate the ON/OFF selector pushbutton to turn the TACAN system on. The TACAN channel number may be changed using the UFC keypad. In the T/R mode the TACAN computes bearing, and measures slant range from the selected TACAN station. In the RCV mode only bearing from the selected TACAN station is computed. In the A/A mode, interrogations and replies are only single pulse from one aircraft to another. TACAN with bearing and range information is plotted on the HSI. When TACAN is boxed on the HSI, range information is displayed on the HSI and HUD. With a course line selected and in NAV mode, steering information is displayed on the HUD and the distance course line is displayed in the lower right corner of the HSI with a C beside it. For example: 15 miles from course line would be displayed as "15 C". This is very useful on the downwind leg of a carrier landing pattern by selecting the carrier TACAN, set the carrier course line, and then fly 1.2 miles abeam of the course line on the downwind leg parallel to the course line until starting the 180° turn.

Please see the TACAN Navigation chapter for greater detail.

**ILS Pushbutton (ILS).** This allows the Instrumented Carrier Landing System (ICLS) channel number and ON/OFF status to be displayed on the UFC scratchpad along with the CHNL option appearing on the UFC Option Window. Now you can actuate the ON/OFF selector pushbutton to turn the ILS on. The ILS channel may be changed (1 to 20) using the UFC keypad. For ILS data to be displayed on the HUD, "ILS" must be boxed on the HSI.

Please see the Instrument Carrier Landing System (ICLS) chapter for greater detail.

**ON/OFF Pushbuttons.** Activates or deactivates selected function.

### *HUD Control Panel*

The HUD control panel allows the pilot to adjust the HUD display and how some data is presented.



Figure 8. HUD Control Panel

1. **HUD Symbology Reject Switch.** This three-position toggle switch has positions of NORM, REJ 1, and REJ 2. With the switch placed to NORM, the normal amount of symbology is provided for all HUD displays. Placing the switch to REJ 1 removes aircraft Mach number, aircraft g, bank angle and pointer, airspeed box, altitude box, peak positive g, and required ground speed cue from the HUD. Placing the switch to REJ 2 removes all REJ 1 symbology plus the heading scale, current heading indication (caret/T), command heading marker, NAV/TACAN range, and the ET/CD timer.
2. **HUD Symbology Brightness Selector Knob.** Sets the brightness of the HUD symbology.
3. **AOA Indexer Control.** This knob controls the brightness of the AoA indexer lights. Currently no function.
4. **HUD Symbology Brightness Selector.** This is a two-position toggle switch with positions of DAY and NIGHT. Placing the switch to DAY provides maximum symbol brightness in conjunction with the HUD symbology brightness control. With the switch set to NIGHT, a reduced symbol brightness is provided in conjunction with the HUD symbology brightness control.
5. **Altitude Switch.** The ALT switch is used to select either radar altitude or barometric altitude for display on the HUD and as the primary altitude source for the mission computer. When the switch is set to RDR (radar), the altimeter altitude followed by an R is displayed in the upper right portion of the HUD display. If radar altitude becomes invalid, such as the aircraft exceeding the 5,000 feet AGL radar altimeter limit, barometric altitude is displayed and a B next to the altitude flashes to indicate barometric altitude is being displayed.

### Advanced Multipurpose Color Display (AMPCD)

The AMPCD (generally referred to as just the MPCD) is a full-color, NVG compatible digital display capable of providing any MENU selectable format except the A/G radar display. The MPCD is driven by either the Digital Map Set (DMS) for HSI displays, or the left DDI for all other MENU selectable formats. Four momentary two-position rocker switches and a rotary knob, located on the front of the MPCD, permit control of MPCD off/brightness, night/day viewing modes, symbology, gain, and contrast.



Figure 9. MPCD

1. **Off/Brightness Control.** This rotary switch powers on the AMPCD when it is rotated out of the OFF position. When DAY is selected on the night/day brightness selector, AMPCD brightness is controlled using this rotary. When NGT is selected, brightness is controlled automatically. (Brightness is always controlled automatically when the HSI format is shown on the AMPCD.)
2. **Night/Day Brightness Selector.** This rocker switch toggles between auto and manual brightness control. When DAY is pressed, AMPCD brightness can be adjusted using the brightness knob to the right. When NGT is pressed, AMPCD brightness is controlled automatically. (Brightness is always controlled automatically when the HSI format is shown on the AMPCD.)
3. **Symbology Control.** Momentary actuations of the upper half of the switch incrementally narrows the symbology, making it sharper and dimmer. Momentary actuations of the lower half incrementally widens the symbology, making it brighter and less sharp.
4. **Gain Control.** Momentary actuations of the upper half of the switch incrementally increases background video brightness. Momentary actuations of the lower half incrementally decrease video brightness.

5. **Contrast Control.** Momentary actuations of the upper half of the switch incrementally increase the contrast of the display. Momentary actuations of the lower half incrementally decrease the contrast of the display.
6. **Heading and Course Set Switches.** At either side of the top of the MPCD are the Course (CRS) and Heading (HDG) switches that allow the pilot to manually set course and headings on the HSI. Both switches are spring-loaded to the center position but can be held up to increase value (degrees) or held down to decrease value (degrees). Increase heading with [LAlt] + [LShift] + [2] and decrease with [LAlt] + [LShift] + [1]. Increase course with [LAlt] + [LShift] + [4] and decrease with [LAlt] + [LShift] + [3].

### *Lower Console Instrument Group*

Aside from the cabin pressure gauge, this group of instruments is dedicated toward defensive systems. These will be discussed in the Defensive Systems portion of this guide.

## Right Instrument Panel

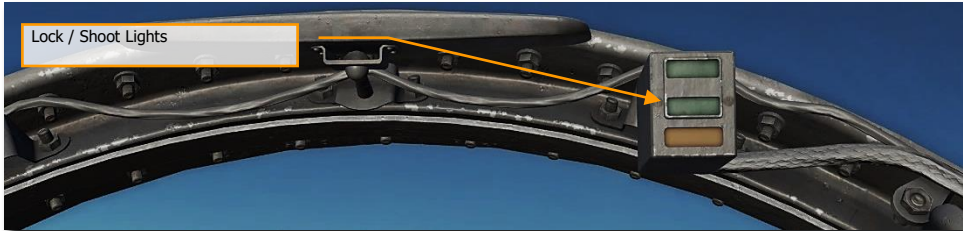

Figure 10. Lock and Shoot Lights

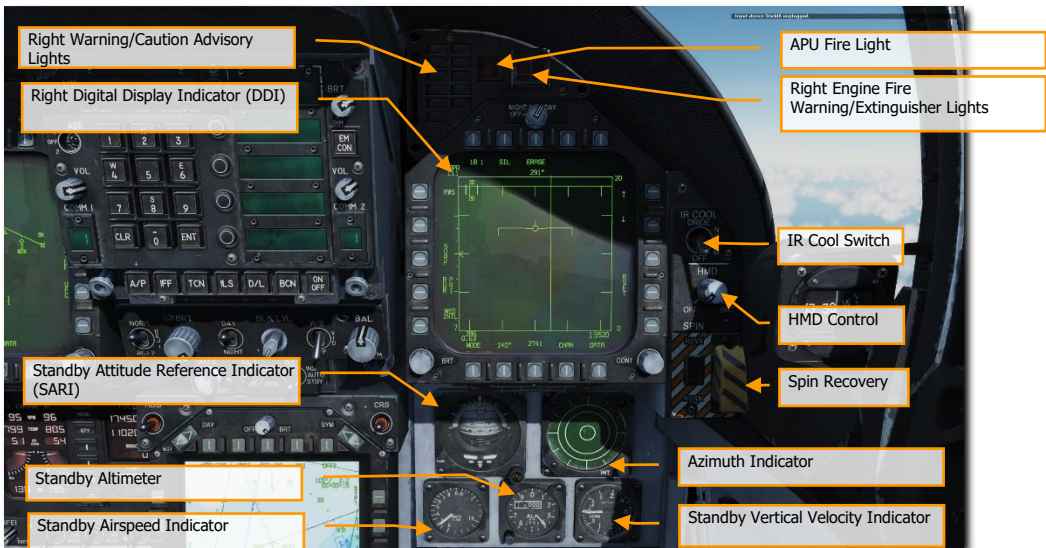

Figure 11. Right Instrument Panel

### Lock / Shoot Lights

The Lock/Shoot cue function is provided during air-to-air (A/A) operation for air-to-air weapons. This function provides a visual indication for radar lock on (LOCK light) and when weapon release interlocks are satisfied (SHOOT light/SHOOT cue).

- Lock: Single Target Track (STT) and target within  $R_{MAX}$  range.
- Shoot / Steady / Missile: target locked and within  $R_{MAX}$  range.
- Shoot / Flashing / Missile: target locked and within  $R_{NE}$  range.
- Shoot / Steady / Gun: target within solution.

The strobe light below the SHOOT cue will also flash when shot is valid.

### *Right Warning/Caution Advisory Lights*

The Right Warning/Caution Advisory lights provide visual indications of the recorder and the onboard Threat Warning System (TWS). See Defensive Systems Chapter for greater details.

- **DISP.** Countermeasure dispense program is active.
- **SAM.** Surface-to-Air Missile tracking radar locked to aircraft. Light is solid when radar is tracking and flashing when guiding a missile.
- **AI.** Airborne Intercept (AI) radar locked to aircraft.
- **AAA.** Ant-Aircraft Artillery (AAA) fire control radar locked to aircraft.
- **CW.** Aircraft illuminated by Continuous Wave (CW) radar.
- **APU Fire Light.** The APU Fire Light will light when a fire has been detected in the APU compartment.
- **Right Engine Fire Warning/Extinguisher Lights.** If a fire is detected in the right engine, this indicator will be lit. It will light when a temperature greater than 1,000 °F is detected in the right engine bay.

### *Right Digital Display Indicator (DDI)*

The right DDI functions identically to the left DDI.

### *IR Cool Switch*

Manually provides coolant to AIM-9 seekers. See AIM-9 procedures section of this guide.

### *Standby Attitude Reference Indicator (SARI)*

This is a self-contained instrument to indicate aircraft pitch, roll, and yaw.



*Figure 12. SARI*

The standby attitude reference indicator (SARI) is a self-contained electrically driven gyro-horizon type instrument. An OFF flag appears if both power sources fail, or if the gyro is caged. During caging the gyro initially cages to 4° pitch and 0° roll regardless of aircraft attitude. Caging when the aircraft is in a roll attitude greater than 5° cuts out the roll erection system and the gyro does not erect properly. After 3 to 5 minutes, the indicator reads 0° in pitch and 0° in roll. Both readings assume the aircraft is straight and level. Pitch display is limited by mechanical stops at approximately 90° climb and 80° dive. As the aircraft reaches a near vertical orientation, the roll display experiences large rotations. An aircraft wings level attitude in the vertical orientation may result in large errors in either pitch or roll, or both. This is normal and is not an indication of damage or improper function of the indicator. After completion of vertical maneuvers, the indicator most likely requires caging in the normal cruise attitude, to eliminate the errors. Vertical maneuvers with a wing down condition of 7° or more usually do not develop significant gyro errors. A needle and ball are at the bottom of the instrument. A one-needle width turn is 90° per minute.

Turn the knob at the bottom right to set the zero-pitch index. Pull the knob to cage the attitude indicator.

### *Azimuth Indicator*

Also referred to as the Radar Warning Receiver (RWR), this is discussed in the Defensive Systems section of this guide.

### *Standby Airspeed Indicator*

The standby airspeed indicator displays airspeed from 60 to 850 knots indicated airspeed. It operates directly off left pitot pressure and left static pressure with NORMAL selected by the static source selector lever or right static pressure with BACKUP selected.

### *Standby Altimeter*

Indication of aircraft barometric altitude. The standby altimeter is a counter-pointer type. The counter drum indicates altitude in thousands of feet from 00 to 99. The long pointer indicates altitude in 50-foot increments with one full revolution each 1,000 feet. A knob and window permit setting the altimeter to the desired barometric setting. This setting is also used by the air data computer. The standby altimeter operates directly off the left static pressure with NORMAL selected by the static source selector lever or right static pressure with BACKUP selected.

### *Standby Vertical Velocity Indicator*

Indication of aircraft positive or negative change of altitude rate.

### *HMD Control*

Rotating the HMD knob clockwise activates the Helmet Mounted Sight and adjusts brightness. Please see the Helmet Mounted Display (HMD) chapter.

### *Spin Recovery*

This control is a hold-over from earlier production lots of the F/A-18C. During later development of the F/A-18C's flight control system, this switch and system was rendered obsolete. In fact, in official F/A-18C flight manuals, it is prohibited from use. Although we have fully-modeled this system for complete accuracy, it should not be used.

The spin recovery system, when engaged, puts the flight controls in a spin recovery mode (SRM). This mode, unlike CAS, gives the pilot full aileron, rudder and stabilator authority without any control surface interconnects and all rate and acceleration feedbacks are removed. The leading-edge flaps are driven to  $33^\circ \pm 1^\circ$  down and the trailing edge flaps are driven to  $0^\circ \pm 1^\circ$ .

- NORM. Spin recovery mode engaged when all the following conditions are met:
  - Airspeed  $120 \pm 15$  knots.
  - Sustained, un-commanded yaw rate.
  - Stick is placed in the direction indicated on the DDI spin recovery display.
  - The flight controls revert to CAS anytime the stick is placed in the wrong direction (i.e., pro-spin), the airspeed increases above about 245 knots, or the yaw rate decreases to less than  $15^\circ/\text{second}$ .
- RCVY. Spin mode engaged when airspeed is  $120 \pm 15$  knots. The flight controls revert to CAS when the airspeed increases above about 245 knots. Full authority pro-spin controls can be applied with the switch in RCVY, and spin mode engaged.

#### Spin Recovery Switch in NORM

With the airspeed at  $120 \pm 15$  knots and a sustained, un-commanded left yaw rate with positive g or sustained, un-commanded right yaw rate with negative g:



Figure 13. Spin Recovery Display



This appears on both DDIs after about a 15-second delay at 15°/second yaw rate decreasing to about a 5-second delay at 50°/second yaw rate.

With the airspeed at 120 ±15 knots and a right yaw rate over 15°/second with positive g or left yaw rate over 15°/second with negative g,



appears on both DDIs after about a 15-second delay at 15°/second yaw rate decreasing to about a 5-second delay at 50°/second yaw rate.

When the stick is placed in the indicated directions, the words

**SPIN MODE**

are replaced by

**SPIN MODE  
ENGAGED**

When the yaw rate decreases below 15°/second or the airspeed increases above about 245 knots, the spin recovery display is replaced by the MENU display.

#### Spin Recovery Switch in RCYV

**SPIN MODE**

Appears on both DDIs.

If the airspeed decreases to 120 ±15 knots, the words

**SPIN MODE**

are replaced by

**SPIN MODE  
ENGAGED**

If a yaw rate over 15°/second develops the words **STICK RIGHT** or **STICK LEFT** with an accompanying arrow also appear on the DDI.

When the airspeed increases above about 245 knots

**SPIN MODE**

appears on both DDIs and the flight controls revert to CAS.

Airspeed appears in the upper left corner, altitude appears in the upper right corner, and AOA appears in the lower center of the spin recovery display.

## Left Vertical Panel

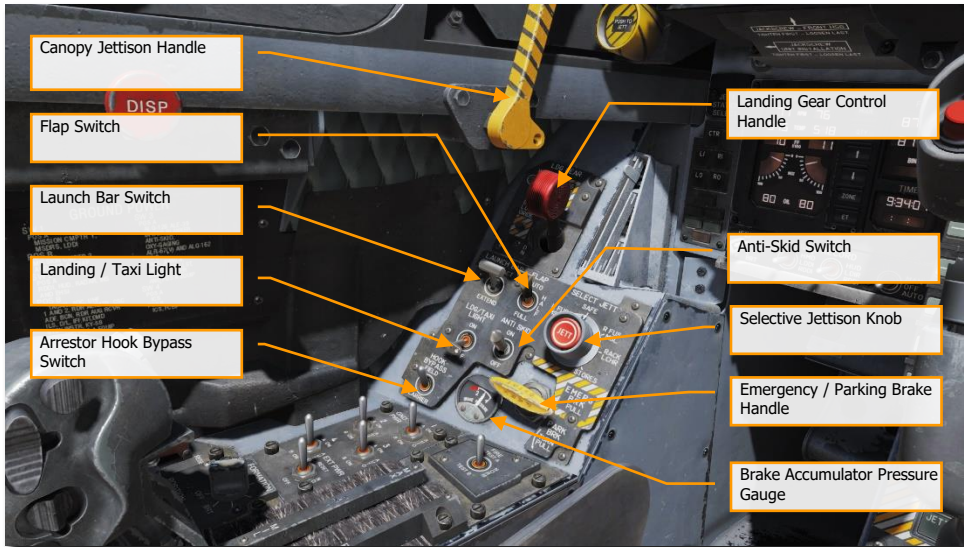

Figure 14. Left Vertical Panel

### Canopy Jettison Handle

The black and yellow striped canopy jettison handle is on the left inboard canopy sill just aft of the instrument panel. Pulling the handle aft activates the canopy jettison system.

### Landing Gear Handle [G]

The landing gear is controlled by a two-position, wheel-shaped handle on the lower left side of the main instrument panel. Two conditions must be met before the gear can be raised: the aircraft must sense that weight is off all three-landing gear and the launch bar must be retracted. When these conditions are met, the landing gear is raised by moving the handle up. If the launch bar is extended when the handle is raised, the main gear retracts but the nose gear remains extended. When the aircraft senses weight on any of the three-landing gear, a mechanical stop in the landing gear control panel extends preventing movement of the handle from DN to UP. Moving the handle down lowers the gear.

The landing gear warning light is a red light in the gear handle. The light comes on when the gear is in transit and remains on until all three gear are down and locked when DN is selected, or all the gear doors are closed when UP is selected. The light remains on with the gear down and locked if the left or right main landing gear link is not locked. When the landing gear handle light has been on for 15 seconds the landing gear aural tone also comes on.

Emergency gear extension is done by rotating the gear handle 90° clockwise and pulling to the detent where the handle locks in place (in the sim, this is done with the mousewheel). This can be done with the handle in either UP or DN; however, the handle must be rotated 90° before it is pulled. Rotating and pulling the gear handle

opens the valves for the emergency landing gear control, the APU accumulator and the emergency brake accumulator. The nose landing gear extends by free fall aided by air loads, and the main landing gear extends by free fall aided by the side brace down lock actuator and the compressed shock absorber. If gear indicates unsafe following emergency extension, it may be the result of the APU accumulator arming valve not opening.

### *Launch Bar Switch*

The launch bar is hydraulically extended and retracted by redundant springs. A locking tab mechanically locks the launch bar in the up position. The two position (EXTEND and RETRACT) launch bar switch controls launch bar operation. As the launch bar extends the green L BAR advisory light comes on. When the launch bar is fully extended it is held against the deck by load control springs. The control springs allow vertical movement of the launch bar during taxi. As the aircraft is taxied into the launch gear the launch bar drops over the shuttle and is held captive in the extended position as the shuttle is tensioned. The green L BAR advisory light goes out when the switch is placed to RETRACT. If the red L BAR warning light is on with the switch in RETRACT, an electrical fault exists which prevents launch bar retraction after launch. At the completion of the catapult stroke, launch bar/catapult separation occurs and the return springs cause launch bar retraction which allows the landing gear to be retracted. If the launch bar fails to retract after the aircraft is launched, the red L BAR warning light comes on and the nosewheel does not retract. A launch bar circuit breaker is on the left essential circuit breaker panel and when pulled de-energizes the launch bar electrical system.

### *Flap Switch*

The FLAP switch selects which of the two flight control computer modes (auto flap up or takeoff and land) is active and thus determines the flight characteristics for those conditions.

- **AUTO.** Without Weight on Wheels (WOW), leading and trailing edge flaps are scheduled as a function of AoA. With WOW, leading and trailing edge flaps and aileron droop are set to 0°. [F]
- **HALF.** Below 250 knots, leading edge flaps are scheduled as a function of AoA. Trailing edge flaps and aileron droop are scheduled as a function of airspeed to a maximum of 30° at approach airspeeds. Above 250 knots, the flaps operate in the auto flap up mode and the amber FLAPS light comes on. On the ground, the leading-edge flaps are set to 12°. The trailing edge flaps and aileron droop are set to 30°. With the wing unlocked, aileron droop is set to 0°. [LShift] + [F]
- **FULL.** Below 250 knots, leading edge flaps are scheduled as a function of AoA. Trailing edge flaps and aileron droop are scheduled as a function of airspeed to a maximum of 45° flaps and 42° aileron droop at approach airspeeds. Above 250 knots, the flaps operate in the auto flaps up mode and the amber FLAPS light comes on. On the ground, the leading-edge flaps are set to 12°. The trailing edge flaps are set to 43° to 45° and aileron droop to 42°. With the wings unlocked, aileron droop is set to 0°. [LCtrl] + [F]

### *Selective Jettison Knob*

The selective jettison knob on the left vertical panel has rotary positions L FUS MSL, SAFE, R FUS MSL, RACK/LCHR, and STORES. L FUS MSL and R FUS MSL selects the required fuselage missile for jettison. The RACK/LCHR and STORES positions select what is to be jettisoned from the weapon stations selected by the station jettison select buttons. The JETT center pushbutton activates the jettison circuits provided the landing gear is up and locked and the master arm switch is in ARM. The SAFE position prevents any selective jettison.

### *Landing / Taxi Light*

This is a combination landing and taxi light located on the nose gear strut. The light is controlled by the LDG/TAXI light switch on the left vertical panel.

- **OFF.** Light is off.
- **ON.** If the landing gear handle is in DN and the landing gear is down, the light is on.

### *Anti-Skid Switch*

The anti-skid circuit prevents brake application on landing until wheel speed is over 50 knots, or if a wet runway delays wheel spin-up, 3 seconds after touchdown. A locked wheel protection circuit releases the brakes if the speed of one main wheel is 40% of the other main wheel. The locked wheel protection circuit is disabled at about 35 knots. The anti-skid system is totally disabled below 10 knots. Anti-skid is used for airfield operation, but not for carrier operations.

### *Emergency / Parking Brake Handle*

The combination emergency/parking brake handle is on the lower left corner of the main instrument panel. The handle is shaped such that EMERG is visible to the pilot when the handle is in the stowed or emergency position and PARK is visible to the pilot when the handle is rotated to the park position.

The parking brake system uses the same hydraulic lines, accumulators, and actuation handle as the emergency brake system. The system is activated by rotating the emergency/parking brake handle 90° counterclockwise from the horizontal stowed position and pulling it out to a positive locked position. If the emergency brakes have been activated, it is necessary to reposition the handle to the stowed position then rotate it 90° counterclockwise and pull it to the locked position to select parking brakes. This action applies non-regulated pressure to the disc brakes. With the INS on, the parking brake set, and both throttles above about 80% rpm, the PARK BRK caution and MASTER CAUTION come on. To release the parking brake, rotate the emergency/ parking brake handle 45° counterclockwise from the extended position. This releases the lock and allows the handle to return to the horizontal stowed position.

### *Brake Accumulator Pressure Gauge*

Brake accumulator pressure is shown on a pressure gauge on the lower left corner of the main instrument panel and is redlined to indicate pressure below 2,000 psi. 3,000 psi is a normal level.

### *Arrestor Hook Bypass Switch*

With this switch set to the CARRIER position, the AoA Indexer Lights will light solid when the arrestor hook and landing gear are down and locked. It will however flash if the arrestor hook is up. When set to FIELD, the AoA Indexer Lights will stay solid when the arrestor hook is not down. Lowering the arresting hook will release a solenoid and move the switch to the CARRIER position.

## Left Console

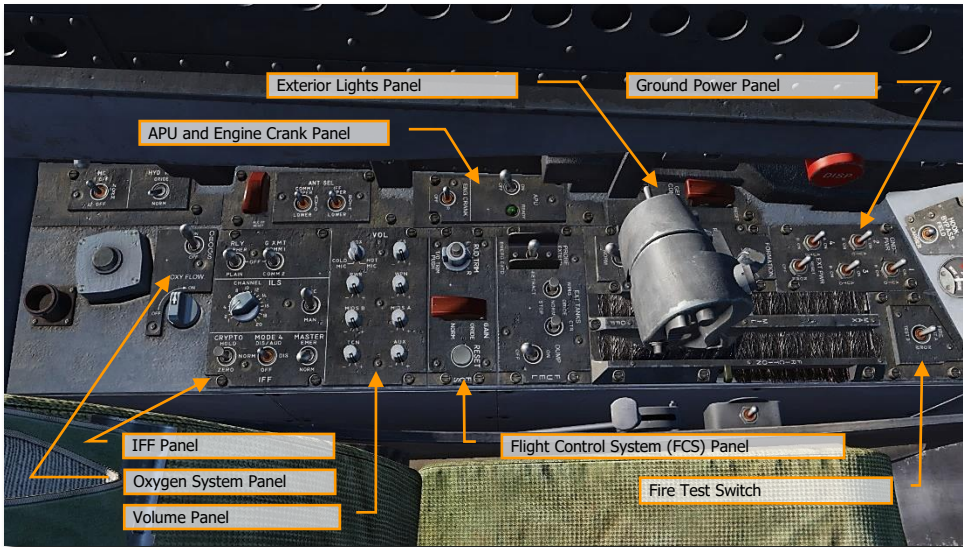

Figure 15. Left Console

### Ground Power Panel

To avoid using the battery to start the aircraft, or to run electrical systems without starting the aircraft, the ground power panel is used once electrical power is requested from the ground crew. Once EXT PWR (External Power) is selected from the panel, four electrical power groups can be selected, with each having subsidiary A and B groups of instruments and systems being powered by the parent group.

To start the aircraft while on ground power, connect external power and do the following:

1. EXT PWR switch — RESET
2. GND PWR switches 1, 2, and 4 — B ON and hold for 3 seconds

### Fire Test Switch

The fire/bleed air leakage detection sensors and associated circuits are tested by the fire and bleed air test switch. Operation of the fire and bleed air test switch requires power on the essential 24/28-volt DC bus. The fire and bleed air switch is on the fire test panel on the left console. When actuated to TEST A or TEST B, the fire warning, bleed air leak detection and voice alert warning circuitry for the designated loop is tested.

Switch actuation turns on the L BLEED and R BLEED warning lights and the L BLD OFF and R BLD OFF caution displays

The L(R) BLEED warning lights go out after the switch is released to NORM.

- **TEST A** Turns on the three red fire warning/extinguisher lights, activates the voice alert ("Engine Fire Left, Engine Fire Left", "Engine Fire Right, Engine Fire Right", "APU Fire, APU Fire", Bleed Air Left, Bleed Air Left", Bleed Air Right, Bleed Air Right", turns on the two bleed air warning lights and two caution displays, indicating that Loop A fire detection sensors and circuitry are operational.
- **TEST B** Turns on the three red fire warning/extinguisher lights, activates the voice alert ("Engine Fire Left, Engine Fire Left", "Engine Fire Right, Engine Fire Right", "APU Fire, APU Fire", Bleed Air Left, Bleed Air Left", Bleed Air Right, Bleed Air Right", turns on the two bleed air warning lights and two caution displays, indicating that Loop A fire detection sensors and circuitry are operational.

This is a spring-loaded switch, and if released will return to center and the last audio message will finish.

### *Exterior Lighting Panel*

Three lighting controls comprise this panel:

- **Position Lights.** The position lights include a white light just below the tip of the right vertical tail fin, three green lights on the right side of the aircraft, and three red lights on the left side of the aircraft. The position lights are controlled by the POSITION lights knob. The exterior lights master switch must be ON for the position lights knob to operate.
- **Formation Lights.** Eight formation lights are provided. Two lights are on each wing tip, two lights are on the outboard of the vertical tail fins, two lights are on the aft fuselage below the vertical tail fins, and two lights are on either side of the forward fuselage just forward of the LEX. The formation lights are controlled by the FORMATION lights control knob on the exterior lights panel which provides variable lighting between positions OFF and BRT. The exterior lights master switch must be ON for the formation lights knob to operate.
- **Strobe Lights.** Two red anti-collision strobe lights, one on each outboard vertical tail fin, are provided. The strobe lights are controlled by the STROBE lights switch on the exterior lights panel. The exterior lights master switch must be ON for the strobe lights switch to be operative.
  - **OFF** Lights are off.
  - **BRT** Lights illuminate at full intensity.
  - **DIM** Lights illuminate at reduced intensity.

### *APU and Engine Crank Panel*

The APU switch is a two-position switch with positions of ON and OFF. OFF Provides a manual shutdown for the APU. ON Starts the start cycle of the APU. Switch is electrically held in the ON position and automatically returns to OFF 1 minute after the second generator comes on the line.

The APU is a small aircraft mounted gas turbine engine used to generate a source of air to power the air turbine starter(s). It is situated on the underside of the fuselage between the engines, with both intake and exhaust facing downwards. A hydraulic motor powered by the APU accumulator, normally charged by HYD 2B, is used to start the APU. A hand pump may be used to charge the accumulator. The aircraft battery provides electrical power for the APU ignition and start control circuits. The APU uses aircraft fuel.

Operation of the APU is automatic after the APU switch, on the left console, is placed to ON. The APU may be shut down at any time by placing the APU switch to OFF. After the APU has completed its start cycle a green READY light comes on. After the second generator is online, the APU runs approximately 1 minute then the APU switch returns to OFF.

Either engine may be started first; however, starting the right engine first provides normal hydraulic pressure to the brakes. After the APU READY light is on, place the electrically held engine crank switch to R. This opens the right air turbine starter control valve.

(ATSCV) and APU air powers the ATS. The ATS in turn cranks the right engine by way of the AMAD gearbox and power transmission shaft. After the right generator comes online the engine crank switch automatically returns to OFF. The left engine is started the same way as the right. One minute after the second generator comes online the APU shuts down.

### *Flight Control System (FCS) Panel*

Movement of the rudder trim knob on the FCS control panel electrically biases the flight control computers. The rudder pedals do not move.

The T/O trim button is in the center of the rudder trim knob on the FCS panel. With WOW, holding the button down drives the roll and yaw trim to the neutral position, stabilator 12° nose up, and zeros the mechanical stick position. When the roll and yaw control surfaces are trimmed to neutral and the stabilator to 12° nose up, the TRIM advisory is displayed on the DDI until the button is released. In flight, pressing the T/O trim button only neutralizes the mechanical stick position.

### *Volume Panel*

The volume controls (TCN, WPN, and RWR) on the volume control panel adjusts the volume of each audio source individually.

- **TCN.** TACAN audio code volume.
- **RWR.** Radar Warning Receiver audio output volume.
- **WPN.** Weapon audio output volume (e.g., AIM-9 seeker).

### *Oxygen System Panel*

The Oxygen System panel includes control of the Onboard Oxygen Generation Systems (OBOGS). Controls include an ON/OFF switch and a flow selector. Along the left wall are the circuit breakers for FCS channels 1 and 2, as well as for the speed brake and launch bar. The large red button is the countermeasures dispenser button.

### *IFF Panel*

The IFF Panel includes controls for the Mode-4 IFF transponder.



Figure 16. Crypto Panel

**CRYPTO.** Controls storage of the encrypted mode-4 identification keys.

- NORM. Mode-4 identification keys are stored, but are zeroized when the aircraft is powered down.
- HOLD. Mode-4 identification keys are not zeroized at aircraft power-down. They will be retained for the next startup. This position is only functional when the landing gear is down.
- ZERO. Mode-4 identification keys are immediately zeroized. Selecting this option will cause your mode-4 IFF transponder to fail.

**MODE 4.** Controls how the aircraft indicates mode-4 interrogations. The mode-4 transponder will not reply to an unrecognized interrogation from another aircraft. If another aircraft is attempting to interrogate your transponder, but your transponder does not recognize their identification key, you will appear as unknown/non-friendly to them.

- DIS/AUD. If a valid interrogation is received, "M4 OK" is displayed. If an unrecognized interrogation is received, an "IFF" voice alert is played.
- DIS. If a valid interrogation is received, "M4 OK" is displayed. No indication is given for an unrecognized interrogation.
- OFF. No indication is given for recognized or unrecognized interrogations.

**MASTER.** When set to EMER, responds to all interrogations with the emergency code. This will alert controllers that you are experiencing an emergency.

## Right Vertical Panel

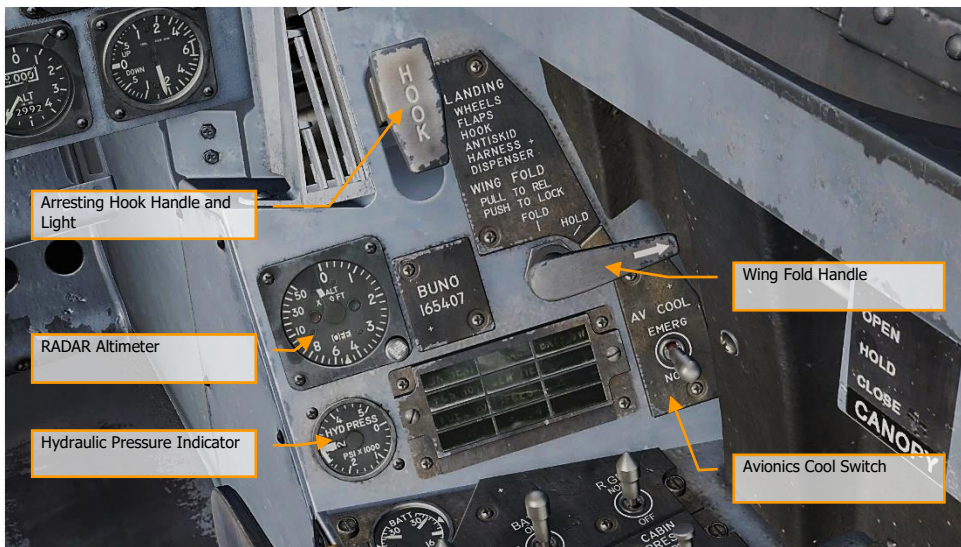

Figure 17. Right Vertical Panel



## Standby Magnetic Compass

A conventional aircraft magnetic compass is mounted on the right windshield arch.



Figure 18. Standby Magnetic Compass

## Arresting Hook Handle and Light

To extend the arresting hook, place the arresting hook handle down. The HOOK light comes on when the hook is in transit and goes out when the hook reaches the selected position. The light remains on if the hook is in contact with the deck and is prevented from reaching the hook down proximity switch. The HOOK light remains on any time the hook position does not agree with the handle position. Lower and raise with **[H]**.

## Wing Fold Handle

Normal folding and spreading the wings is accomplished through operation of the wing fold handle. To fold the wings, pull out and rotate counterclockwise to FOLD. The MASTER CAUTION light comes on. To spread the wings, rotate the wing fold handle clockwise to SPREAD. To lock the wings after they have fully spread, push the handle in. The wings can be stopped and held in any intermediate position by placing the wing fold handle to HOLD.

## Radar Altimeter

The radar altimeter set indicates clearance over land or water from 0 to 5,000 feet. Operation is based on precise measurement of time required for an electromagnetic energy pulse to travel from the aircraft to the ground terrain and return. Voice alert and/or warning tone and visual warnings are activated when the aircraft is at or below a selectable low altitude limit. The set consists of a receiver-transmitter, individual transmitting and receiving antennas, and a height indicator. The receiver-transmitter produces the energy pulses, transmits the energy to the ground, receives the reflected signal and processes this data for display as altitude by the head-up display unit (HUD) and the height indicator. The height indicator, on the instrument panel, consists of a calibrated

scale from 0 to 5,000 feet, a push-to-test switch, a low altitude index pointer, an altitude pointer, an OFF flag, a low altitude warning light, and a BIT light.

### *Hydraulic Pressure Indicator*

The left, or system 1, provides power to the primary flight control surface actuators exclusively. The right, or system 2, also provides power to the primary flight control actuators and additionally supplies power to the speed brake and non-flight control actuators.

### *Right Warning / Caution Advisory Lights*

All lights on this panel are steady state, yellow lights.

- **APU ACC.** Indicates that the APU accumulator pressure necessary for the starting the engine is inadequate.
- **FUEL LO.** Indicates the fuel quantity remaining is below 800 pounds in either of the two feed tanks. FUEL LO will remain on for at least one minute for each fuel low occurrence to avoid repetitive occurrences due to fuel sloshing.
- **L GEN.** Indicates that the left generator output has failed or is turned off.
- **R GEN.** Indicates that the right generator output has failed or is turned off.
- **BATT SW.** Battery switch is set to ON.
- **FCS HOT.** The flight control computer and transformer/rectifier are undercooled. This is due to insufficient avionics cooling in the right-hand equipment bay. In such a situation, the EMERG position on the AV Cool switch should be selected.
- **FCES.** A function has been lost in one or more axis of the Flight Control Electronics Systems. Loss of one of the eleven flight control functions.
- **GEN TIE.** GEN TIE switch set to RESET.
- **CK SEAT.** Ejection seat has not been armed.



the emergency battery contactor will subsequently close in response to a low voltage condition from the utility battery output and left 28-volt DC bus.

- **ORIDE.** Energizes emergency battery contactor regardless of charge status of the utility battery, providing voltage on left 28-volt DC bus is absent or low. Position can be used to connect the emergency battery to the essential buses in the event utility battery contactor fails to energize with switch in the ON position.

### *Environmental Control System Panel*

The ECS panel controls include:

- **Bleed Air Select Switch.** This switch controls the bleed air source. Bleed air is automatically shut off if a leak is detected.
  - **BOTH.** Bleed airflow is provided to the ECS by both engines.
  - **R OFF.** Bleed airflow is provided to the ECS by only the left engine.
  - **L OFF.** Bleed airflow is provided to the ECS by only the right engine.
  - **OFF.** All bleed airflow from the engines is shut off. This includes ECS cooling, cabin pressurization, and warm air. Ram air is automatically used instead.
  - **AUG.** Allows the APU to augment bleed air pressurization of the cabin when the aircraft has weight on wheels and engine operating at less than intermediate settings.
- **Engine Anti-Ice Switch.** This switch controls anti-ice heating of the engine inlets.
  - **ON.** Allows hot bleed air to circulate through the engine inlet and engine components.
  - **OFF.** Turns off engine anti-ice.
  - **TEST.** Triggers ice caution message.
- **Pitot Heater Switch.** There are two pitot-static tubes mounted under the nose on each side forward of the nosewheel well. Each tube contains one pitot source and two static sources. The pitot heater switch on the ECS panel has positions ON and AUTO.
  - **AUTO.** Heaters are on when airborne.
  - **ON.** Heaters are on when AC power is available.

### *Interior Lighting Panel*

The interior light panel controls all illumination options and settings within the cockpit.

- **Console Lighting Knob.** Integral and light panel lighting for the left and right consoles and both cockpit circuit breaker panels are controlled by the CONSOLES knob which provides variable lighting between positions OFF and BRT. With the MODE knob in the NVG position, the CONSOLES knob provides variable NVG floodlighting between OFF and BRT for the consoles.
- **Instrument Lighting Knob.** Integral and light panel lighting for the instrument panel, UFC background, right and left vertical panels, and standby magnetic compass are controlled by the INST PNL knob which provides variable lighting between positions OFF and BRT. The INST PNL knob provides variable lighting between OFF and BRT, with the MODE switch in either NORM or NVG.

- **Flood Lighting Knob.** Eight white floodlights are provided for secondary lighting. Three console floodlights are above each console, and an instrument panel floodlight is located to either side of the instrument panel. The FLOOD knob is inoperative with the MODE switch in the NVG position.
- **Chart Lighting Knob.** A chart light is installed on the canopy arch. An NVG compatible chart light is controlled by the CHART knob and rotates in two axes with variable lighting between OFF and BRT. The chart light operates independent of the MODE switch position.
- **Lights Test Switch.** A lights test switch, labeled LT TEST, is provided to test the warning/caution/advisory lights in addition to the AOA indexer lights and the integrated fuel/engine indicator LCD displays.
- **Warning and Caution Lights Knob.** A knob labeled WARN/CAUT is provided on the interior lights control panel to vary the brightness of the warning/caution/advisory lights within the low intensity range. The warning/caution/advisory lights can be switched to the low intensity range by placing the warning/caution lights knob momentarily to RESET, if the INST PNL knob is out of the OFF position, and either the FLOOD knob is out of OFF but less than 70% of BRT or the flood switch is in CHART.

The warning/caution lights come on at a reduced brightness in the NITE and NVG mode. Once in the low intensity range, the warning/caution/advisory lights can be brought back to high intensity by turning the MODE switch to the DAY position. With power interruption and the MODE switch in NVG, the lighting system remains in the NVG mode when power is restored. With power interruption and the MODE switch in DAY or NITE, the lighting system defaults to the DAY mode when power is restored.

- **Mode Switch.** The MODE switch has positions of NVG, NITE, and DAY. The DAY position permits the maximum brightness range for the warning, caution, and advisory lights and the main and console panel lighting. The NITE position provides reduced brightness for the warning, caution, and advisory lights, and normal intensity for the main and console lighting. The NVG position provides reduced brightness for the warning, caution, and advisory lights, disables the integral console lighting, and enables NVG compatible floodlights to illuminate the consoles. The IFEI brightness knob is only functional in NITE and NVG modes.

### *Sensors Panel*

- **INS Knob.** This eight-position rotary knob controls the inertial navigation system.
  - **OFF.** Removes power from the INS.
  - **CV.** Places the INS in carrier alignment mode.
  - **GND.** Places the INS in ground alignment mode.
  - **NAV.** Places the INS in navigation mode.
  - **IFA.** Places the INS in inflight alignment mode.
- **RADAR Knob.** Four position rotary knob controls all operating power applied to the radar set.
  - **OFF.** Removes all radar set power.
  - **STBY.** Activates all components except for high voltage. Allows radar set to warm-up before application of high voltage; or, removes high voltage but maintains radar for immediate application of high voltage.
  - **OPR.** Commands radar to full operation if all safety interlocks have been satisfied and initial warm-up time is complete.

- **FLIR Switch.** Three position toggle switch that controls electrical power to the ATFLIR or Litening targeting pod.
  - **OFF.** Removes all electrical power from the targeting pod.
  - **STBY.** Turns on standby electrical power, enables detector cool down.
  - **ON.** Turns power on for FLIR.
- **Laser Target Designator/Ranger (LTD/R) Switch.** Two position lever locked switch that must be lifted before it can be moved to the magnetically held position. The LTD/R switch enables arming of the laser when all other interlocks are met.
  - **SAFE.** Inhibits laser arming.
  - **ARM.** Enables laser arming. Magnetically held in ARM position when all interlocks are met.
- **Laser Spot Tracker/Navigation FLIR (LST/NFLIR) Switch.** Two position toggle switch that enables or disables LST/NFLR.
  - **OFF.** Disables primary power to the interconnecting box.
  - **ON.** with the LST/NFLR switch in the ON position, the primary power relay is energized. The 28vdc power is supplied to the 5vdc regulators and is filtered.

Along the right wall are the canopy control switch, the FCS BIT switch, and circuit breakers for the arrestor hook, landing gear, and FCS channels 3 and 4.

### *Internal Canopy Switch*

The internal canopy switch has three positions: OPEN, CLOSE and HOLD.

- **OPEN.** Raises canopy to maximum position. If selected when canopy is locked, the canopy unlocks, then moves 1.5 inches aft before rising. With WOW, the OPEN position is solenoid held until the maximum up position is reached, after which it is spring loaded to the HOLD position. The solenoid can be overridden at any time by placing the switch to HOLD. With weight off wheels, the switch must be held in the OPEN position to open the canopy. Objects/Grimes light placed in the area near the canopy switch could inadvertently shift causing actuation of the canopy switch airborne resulting in loss of canopy.
- **HOLD.** Stops the canopy at any point during the open or close cycle.
- **CLOSE.** Lowers canopy. If held after canopy reaches canopy sill, canopy moves forward 1.5 inches and then locks. Locked condition indicated by MASTER CAUTION light and CANOPY display going out. CLOSE position is spring loaded to the HOLD position.

## Audio Tones

The F/A-18C has a variant of audio tones that consist of the following:

**Departure Warning Tone.** The Departure Warning tone is a high-pitched solid or broken tone that occurs when certain AoA limits are exceeded.

**Master Caution Tone.** Whenever the master caution is triggered, the master caution tone will sound. It has a "deedle deedle" sound.

**Radar Warning Receiver Tones.** There are three tones associated with the RWR:

- RWR Status Change. This descending three tone is heard when an RWR contact changes status (i.e., search mode to lock mode).
- New RWR spike detected. This single, short tone is heard when a new RWR signal is detected.
- Launch tone. When a radar guided missile launch is detected, this repeating, multi-pitch tone is heard while the threat is detected.

**FCS Voice Alerts.** Any FCS caution except CHECK TRIM, FCS, NWS, FC AIR DAT, g-LIM OVRD, or R-LIM OFF is accompanied by a "flight controls, "flight controls" voice alert. An engine fire would be result in "Engine Fire Left" and/or "Engine Fire Right". An APU fire would result in "APU Fire". A bleed air failure will result in either a "Bleed Air Left" and/or "Bleed Air Right".

- "Flight controls, flight controls"
- "Engine fire left, engine fire left"
- "Engine fire right, engine fire right"
- "APU fire, APU fire"
- "Bleed air left, bleed air left"
- "Bleed air right, bleed air right"
- "Flight computer hot"
- "Fuel low"
- "Bingo"
- "Altitude"

All voice alerts are repeated twice (e.g., "Engine Fire Left, Engine Fire Left")

**Primary Radar Low Altitude Warning.** If the landing gear is up and locked and the radar altitude is less than the Low Altitude Limit index, the primary low altitude warning tone/voice alert is heard in the pilot's headset. A "whoop whoop" warning tone is heard. The voice alert or warning tone is activated at ground power-up to familiarize the pilot with the warning. When first activated in flight, the warning is continuously repeated until reset or disabled. The warning is reset by setting the low altitude index to an altitude below the present altitude or by climbing to an altitude above the low altitude index setting. The warning can be disabled by pressing the RALT button on the UFC or by commanding the UFC to another mode. Once disabled it cannot be triggered until after being reset as described above.

With an MC1 failure, the voice alert/warning tone is not sounded when the aircraft descends below the altitude set by the low altitude index pointer.

With landing gear down, the radar altimeter warning sounds once when the aircraft descends through the set altitude.

# CONTROL STICK & THROTTLES

## Control Stick

The stick contains the pitch and roll trim switch, sensor control switch, Air-to-Ground bomb release button, gun/forward-firing weapons trigger, Air-to-Air weapon select switch, undesignate/nosewheel steering button. An autopilot/nosewheel steering disengage switch (paddle switch) is mounted below the stick grip. Stick position sensors transmit an electrical signal proportional to stick displacement from neutral to the flight control computers.

Several of the switches have multiple functions that depend on a selected mode. We will discuss those in the later, relevant sections of this manual.

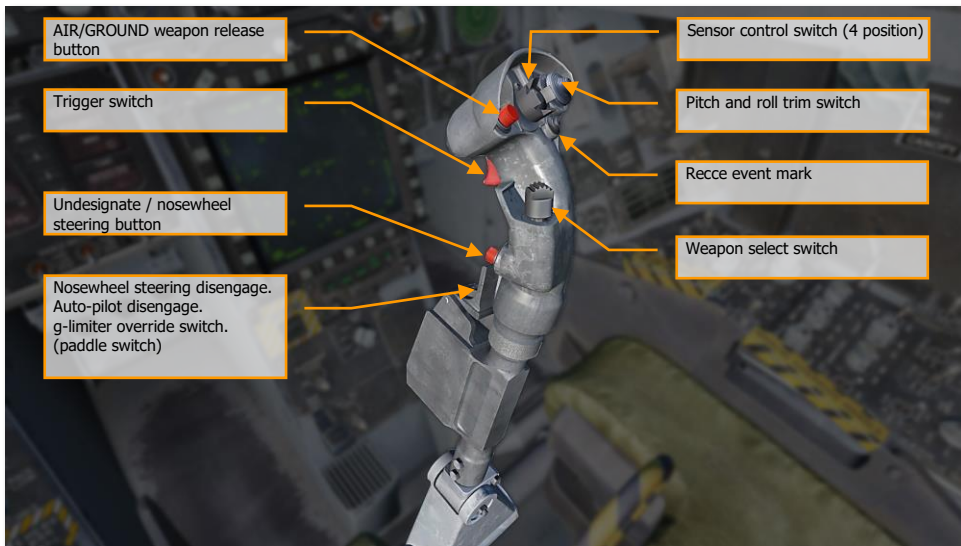

Figure 20. Control Stick

**Weapon release button [RAIt] + [Space].** Press and hold to launch air-to-ground weapons, including bombs, rockets, and air-to-surfaces missiles.

**Trigger switch [Space].** Press to fire the gun and air-to-air missiles.

**Undesignate/nosewheel steering button [S].** This button has different functions depending on the state of the aircraft:

**Nosewheel Steering.** With weight on wheels and the flight control computers operating, momentarily pressing the nose-wheel steering button activates and engages nose-wheel steering and NWS is displayed on the HUD.



If the nosewheel steering system fails, NWS and FCS are displayed on the DDI as cautions, the MASTER CAUTION light comes on, and the NWS or NWS HI display is removed from the HUD. When failed, the nosewheel steering system reverts to a free swiveling mode.

**Undesignate.** When not in a nose-wheel steering state (weight off wheels), this button is used to undesignate a previously designated target or location. This commands radar return to search and undesignates targets.

**Nosewheel steering disengage [A].** This paddle switch has multiple functions depending on the state of the aircraft. Functions include:

- **Nosewheel Steering.** Disengages commanded nosewheel steering. If the high mode is desired during taxi, press and hold the nosewheel steering button. If the wings are folded and NWS is engaged, high gain mode is entered by pressing and releasing the NWS button.
- **Autopilot Disengage.** Disengage the commanded autopilot mode and return to manually controlled flight.
- **G Limiter Override.** The g limiter may be overridden by momentarily pressing the paddle switch with the control stick near full aft. Command limit g is then increased by 33%. A g-LIM OVRD caution is displayed, and the MASTER CAUTION light and tone come on. Override is disengaged when the control stick is returned to near neutral.

**Pitch and roll trim switch.** Normally, movement of the pitch ([RCtrl] + [.] and [RCtrl] + [;]) and roll ([RCtrl] + [,] and [RCtrl] + [/]) trim switch electrically biases the flight controls and the stick does not move (unlike the A-10C and Black Shark). Little if any pitch trim is required in the AUTO flap mode due to the automatic trimming functions within the flight control computers. Only in landing configuration will manual pitch trim be required. If there is asymmetric loading, roll trim will be required. In MECH, pitch trim moves the control stick fore and aft, changing the stick neutral point. There is no mechanical lateral trim.

Trim changes the tracked g loading up to 25° AoA. It is normally 1 g. Disengaging the autopilot in a level 2 g, 60° bank angle turn will leave the stick trimmed for 2 g. This then requires significant stick force to hold the nose down while in level flight. Re-engaging either Altitude Hold or Attitude Hold with wings level should reset the trim back to 1 g. To better support game play, it is suggested that the aircraft return to 1 g when AP is disengaged under all conditions.

If flaps are down, pitch trim functions like other trim switches, holding the trim switch results in continuous linear changes until the switch is released. Trim input with flaps down sets the flight control computers to target an angle of attack. With flaps up, trim inputs more than one second are ignored. Trim inputs with flaps up results in changes to tracked g.

**Recce event mark [R].** In the early access, this can be used to blank the helmet mounted display when pressed.

**Weapon select switch.** Four position switch which selects A/A weapon in A/A aircraft master mode. Switch functions are discrete inputs.

- **Forward [LShift] + [W]:** Activates AIM-7, displays the priority missile. Commands a radar antenna four bar elevation, 140° azimuth scan, 40-mile range selection, and interleaved PRF.
- **Center Push [LShift] + [S]:** Activates AIM-9 and displays the priority missile. Commands a radar antenna four bar elevation, 80° azimuth scan, 40-mile range selection for AIM-9L, AIM-9M and AIM-9X, and interleaved PRF.

- **Aft [LShift] + [X]:** Activates gun and displays gun. Commands GACQ to the radar system, a range of 5nmi, radar antenna azimuth scan of five bars, with 20° elevation scan (vertical scan). Configures sensor control switch to the ACM condition.
- **Right [LShift] + [D]:** Activates AIM-120 and displays priority missile. Commands a radar antenna two-bar elevation, 80° azimuth scan, 40-mile range selection for AIM-120B/C, and interleaved PRF.

**Note:** *If a target is tracked as the L&S, the weapon select switch should only change the weapon and not affect radar operation based on weapon selection.*

**Sensor control switch (4 position).** This is a four position, momentary, centering switch. Switch functions are discrete inputs.

- **Forward [RAIt] + [;]:** When in NAV or A/G mode, this assigns throttle designator control (TDC) priority to Head-Up Display (HUD). When in A/A mode, this also places the HUD in the ACM sub-mode and radar in boresight.
- **Aft [RAIt] + [.]**: When in A/G mode, this assigns TDC priority to Advanced Multipurpose Color Display (AMPCD). When in A/A mode, this assigns the TDC to the AMPCD SA page. If in an A/A ACM sub-mode, this puts radar in vertical acquisition (VACQ). If in NAV mode, this toggles the AMPCD between the HSI and SA formats.
- **Left [LAIt] + [;,]**: Assigns TDC priority to the LDDI. If TDC priority is already assigned to the LDDI and LDDI is radar display, commands radar to track mode STT when TDC is over a radar return. If radar is tracking, commands break lock (not undesignate). In A/A ACM sub-mode, commands wide acquisition (WACQ) to radar system. If TGP FLIR is displayed on the LDDI, it will command a track in either A/A or A/G.
- **Right [RAIt] + [/]**: Assigns TDC priority to the RDDI. If TDC priority is already assigned to the RDDI and RDDI is radar display, commands radar to track mode STT when TDC is over a radar return. If TGP FLIR is displayed on the RDDI, it will command a track in either A/A or A/G.

**Note:** *All ACM modes will automatically lock a target.*

## Throttles

The throttle grips contain switches that provide various systems control without moving the hand from the throttles. As with the control stick, the HOTAS functions of the throttles vary in functionality depending on the state and operational modes of the aircraft. These are discussed in the appropriate sections of this document.

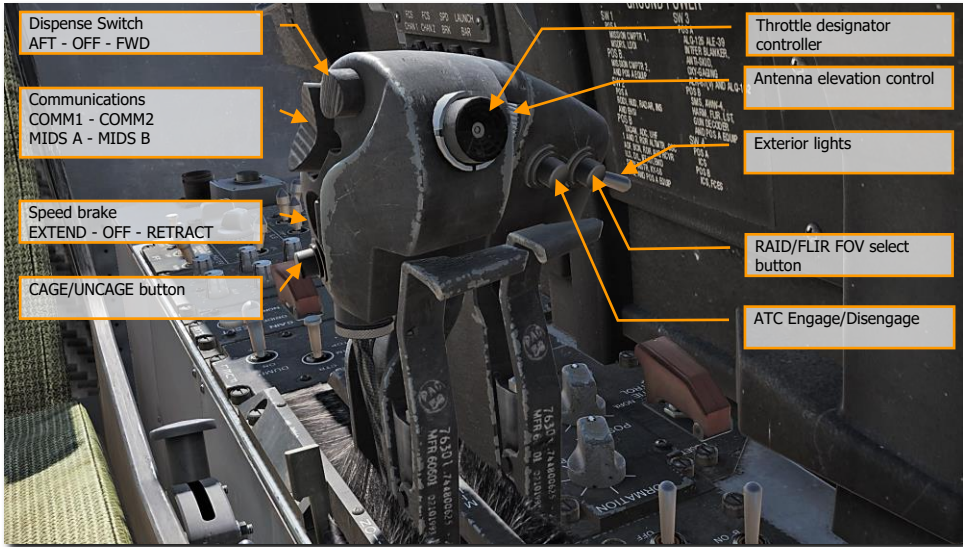

Figure 21. Throttles

**Dispense Switch, AFT - OFF - FWD.** This three-way switch allows manual and semi-automatic use of the ALE-47 countermeasure system.

- **Forward [E].** Activates countermeasures program 5.
- **Center.** No function.
- **Aft [D].** Activates the countermeasures program selected on the EW page.

When the Dispenser selector knob is in **BYPASS**, the switch has an alternate function:

- **Forward [E].** Dispenses a single chaff.
- **Center.** No function.
- **Aft [D].** Dispenses a single flare.

**Communications, COMM1 - COMM2 - MIDS A - MIDS B.** This is a four-position switch that controls transmission over the four radios.

- **Forward.** Transmit over COMM1.
- **Aft.** Transmit over COMM2.
- **Down.** Transmit over MIDS A.
- **Up.** Transmit over MIDS B.

**Speedbrake EXTEND - OFF - RETRACT.** The speedbrake is mounted between the vertical stabilizers. It is controlled by a throttle mounted switch. Airborne, when in the **AUTO FLAPS UP** mode, the speedbrake

automatically retracts above 6.0 g or above 28° AOA and, when not in the auto flaps up mode, below 250 knots. The speedbrake will automatically retract if flaps are extended unless the speedbrake switch is held aft. The speedbrake extends with the flaps HALF or FULL so long as the switch is held in EXTEND. The speedbrake can be commanded to extend to any intermediate position but will retract fully with a momentary forward press of the speedbrake switch. The speedbrake operates normally on the ground.

With flaps extended and weight on wheels (after landing or during an abort for example), the speed brake remains extended without holding the speed brake switch aft.

- **Aft [LShift] + [B]**. Extends the speed brake while the switch is held aft. Spring-loaded to center detent.
- **Forward [LCtrl] + [B]**. Retracts the speed brake or maintains the speed brake retracted and prevents creep.
- **Center [B]**. Speedbrake will creep closed if open when speed is greater than 400 kts.

**CAGE/UNCAGE button [C]**. This switch has multiple functions that depend on the active system or weapon.

- **NAV Mode**. Used to cage or uncage the velocity vector on the HUD.
- **A/A Mode, AIM-9**. Controls Sidewinder seeker position. AIM-9 seeker head is boresighted until L&S designation, then it is slaved to the L&S. Pressing the cage button with an L&S, toggles the seeker head between the L&S and boresight. Pressing and holding the cage button with the AIM-9 seeker head in boresight, then maneuvering the aircraft to point at a target heat source, achieving AIM-9 tone rise, then releasing the cage button will result in AIM-9 seeker head tracking the heat source to the gimbals of the missile.
- **A/A Mode, AIM-7**. In A/A mode with Sparrow missile selected, commands radar into STT on the L&S target.
- **A/G Mode, Maverick**. Cages the Maverick to boresight, or uncages it and allows it to slew.

**Throttle Designator Controller (TDC)**. Upon setting TDC to one of the displays, the TDC acts as a slew control to move the cursor / sensor. Controls are up [↑], down [↓], left [←], right [→], and depress [Enter].

- **Not pressed, with left or right force applied:** Positions acquisition symbol left or right at rate proportional to pressure applied to control.
- **Not pressed with up or down force applied:** Positions acquisition symbol up or down at rate proportional to pressure applied to control.
- **Pressed:** Starts acquisition phase. Positions acquisition symbol or designator cursors depending on direction of force applied to control.
- **Released (cursor in tactical area of display):** Commands radar lock-on, target designation, or active processing depending on mode of operation.

With the "Realistic TDC Slew" option enabled under the Special settings for the F/A-18C, the TDC must be held down to slew certain display formats, such as the AGM-65 Maverick.

**Antenna elevation control.** The AN/APG-73 radar can have its antenna dish rotated up and down to alter the radar elevation scan. This rotary allows the pilot to position the antenna elevation scan. Controls are up [↑] and down [↓].

**Exterior lights switch [L].** The exterior lights master switch, on the outboard left throttle grip, provides a master control for the following exterior lights: position lights, formation lights, strobe lights, and refueling probe light.

- **OFF (AFT).** Power for lights controlled by switch is cut off.
- **ON (FWD).** Power is available for lights controlled by switch.

**RAID/FLIR FOV select button [I].** Depending on the controlled sensor or weapon, this button has multiple functions:

- Selects the RAID mode when the radar set operating mode is Track While Scan (TWS) or Single Target Track (STT).
- When HARM is selected, cycles HARM targets from center outwards.
- When ATFLIR or TGP is active, cycles between FOV settings.
- When in Maverick mode, toggles FOV.

**ATC Engage/Disengage [T].** The ATC approach mode is engaged by pressing and releasing the ATC button on the left throttle with the flap switch in HALF or FULL and the trailing edge flaps extended at least 27°. When ATC is engaged in the approach mode, the flight control computer modulates engine thrust to maintain on-speed AOA. The computer uses inputs of AOA, normal load factor, stabilator position, pitch rate, and angle of bank to generate command signals. These signals drive the engine mounted throttle control units which in turn command the engine fuel controls. The computer uses AOA as the primary input to generate command signals. However, normal load factor provides increased stability, stabilator position provides increased or decreased thrust for pilot induced pitch changes, pitch rate provides lead during pitch maneuvers, and bank angle provides additional thrust during banking maneuvers. Normal disengagement is accomplished by pressing the ATC button or applying and holding force to either throttle. Automatic disengagement occurs for the following reasons:

- Flap AUTO up
- AOA sensor failure
- Two or more failures of either trailing edge flap
- Trailing edge flap deflection less than 27°
- ATC button fails
- FCES channel 2 or 4 fails
- WOW
- FCS reversion to MECH or to DEL in any axis
- Left and right throttle angles differ by more than 10° for more than 1 second
- Bank angle exceeds 70°
- Any internal system failure
- Selection of gain ORIDE

**ATC Cruise Mode.** The ATC cruise mode is engaged by pressing and releasing the ATC button on the left throttle with the flap switch in AUTO. When ATC is engaged in the cruise mode, the existing airspeed is used by the flight control computer to modulate engine thrust to maintain this existing airspeed. The existing airspeed is the airspeed being sent from the ADC to the flight control computers via the mission computers. An ADC failure inhibits the ATC cruise mode of operation. The FCC uses true airspeed from ADC via the mission computers at the time of engagement to generate a command signal. This signal is then used as a reference to generate an error signal that drives the engine mounted throttle control units. Normal disengagement is accomplished by pressing the ATC button or applying and holding force to either throttle. Automatic disengagement occurs for the following reasons:

- Flaps HALF or FULL
- ATC button fails

- FCES channel 2 or 4 fails
- FCS reversion to MECH or to DEL in any axis
- Left and right throttle angles differ by more than  $10^\circ$  for more than 1 second
- ADC true airspeed failure
- ADC degraded
- Any internal system failure

# HEADS-UP DISPLAY (HUD)

The Heads-Up Display, or HUD, is one of your most important instruments and provides valuable information as to your aircraft flight performance and weapon / sensor information. In later sections of this guide, we will discuss aspects of the HUD that are specific to certain weapons and sensors, but the HUD does have a common set of information that is almost always displayed.

## Instant Action Mission Practice: F/A-18C Ready on the Ramp

The HUD as pictured below is independent of aircraft Master Mode except for the bank angle scale, vertical velocity, and heading scale.

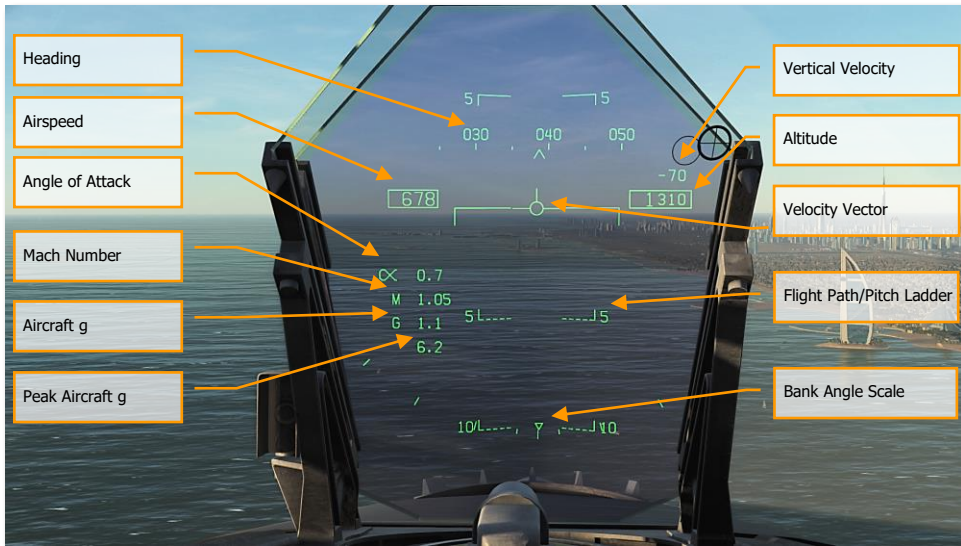

Figure 22. Basic HUD Information

**Heading.** This 30°, moving heading scale displays the aircraft's magnetic or true heading (set in HSI/DATA). The aircraft's heading is indicated as the caret in the center of the scale. When true heading is selected, a "T" is placed below the heading caret.

**Airspeed.** Calibrated airspeed as determined by the Air Data Computer (ADC).

**Vertical Velocity.** Positive or negative aircraft altitude change in feet per minute.

**Altitude.** Barometric or radar altitude in feet as set by the ALT switch on the HUD control panel. When radar altitude is selected, an "R" is displayed next to the altitude box. If the radar altitude is invalid, a flashing "B" is displayed to indicate that barometric altitude is being used instead.

**Angle of Attack.** True angle of attack in degrees of the aircraft.

**Mach Number.** Aircraft speed as Mach airspeed.

**Aircraft g.** Normal acceleration value of the aircraft.

**Peak Aircraft g.** Maximum achieved g over 4 g.

**Velocity Vector.** Represents the point toward which the aircraft is flying along the aircraft's actual flight path. When not displaying accurate information, the symbol will flash. The Velocity Vector can be caged and uncaged to the center of the HUD with the cage/uncage button on the throttle.

**Flight Path/Pitch Ladder.** The vertical flight path angle of the aircraft as indicated by the position of the Velocity Vector on the Flight Path/Pitch Ladder. The aircraft's pitch angle is indicated as the aircraft waterline on the Flight Path/Pitch Ladder.

**Bank Angle Scale.** With marks at 5°, 15°, 30° and 45°, rolling the aircraft to place the center caret in relation to these marks provides a bank angle reference.

**Barometric Setting.** The barometric altitude is displayed below the altitude box for five seconds when the barometric altitude is changed on the standby altimeter. It will also display if the aircraft is below 10,000 feet and at an airspeed less than 300 knots if previously above both values.

**Ghost Velocity Vector.** When the Velocity Vector is caged using the cage/uncage button on the throttle, the Ghost Velocity Vector is displayed and shows the true velocity vector of the aircraft. When caged, the pitch ladder and velocity vector will stay caged to the center of the HUD.

As such, if you find the velocity vector and pitch ladder off-center on the HUD, it is due to yaw or wind. To center these, press the cage/uncage button on the throttle until caged and the Ghost Velocity Vector shows "true" velocity vector.



# DIGITAL DISPLAY INDICATOR (DDI) & ADVANCED MULTI-PURPOSE COLOR DISPLAY (AMPCD) PAGES

In addition to the physical controls of the F/A-18C cockpit, much of your interaction will be through the multitude of pages on the left and right Digital Display Indicators (DDI) and the central Advanced Multipurpose Color Display (AMPCD). The AMPCD is commonly referred to as just the MPCD.

## Instant Action Mission Practice: Ready on the Ramp

Before we discuss common F/A-18C procedures, let's review some of the more important DDI and MPCD pages you'll use. There are two primary pages in which all other pages are selected from: The Support (SUPT) page and the Tactical (TAC) page. You can toggle between these pages, or return to them, by pressing the pushbutton marked MENU. When airborne, the MENU pushbutton converts to a timer, but still acts as a MENU button.

## Support (SUPT) Pages

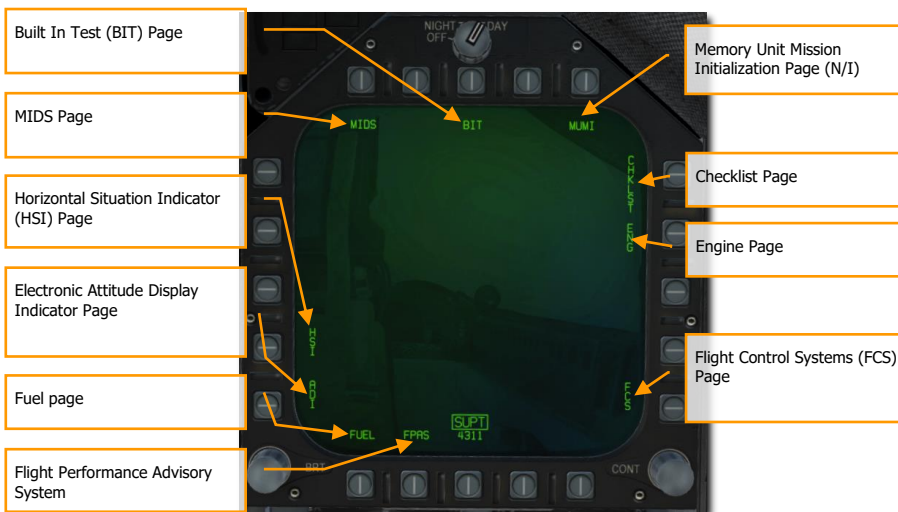

Figure 23. Support (SUPT) Pages

**Built In Test (BIT) Page.** The F/A-18C consists of a numerous sub system, each with has its own built in test system. This page allows the pilot to test these systems and view their status.

**MIDS Page.** See DL16 Datalink.



Figure 24. BIT Page

**Checklist (CHKLST) Page.** In addition to providing checklists for landing and takeoff, this page also displays aircraft weight and stabilator position.

- STAB POS. The horizontal stabilizer position, in degrees followed by NU (nose up) or ND (nose down). Takeoff trim position is 12° NU.
- Maximum vertical g. Maximum vertical acceleration experienced during the most recent landing, rounded to the nearest .01 g.
- Aircraft weight. The aircraft gross weight rounded to the nearest pound.



Figure 25. Checklist Page

**Engine (ENG) Page.** The Engine page provides important engine performance data for both engines, which often duplicates engine data on the IFEI such as engine RPM, engine temperature, fuel flow, and oil pressure. Most often though, you will be using the IFEI to check engine performance.

- INLET TEMP. Engine inlet temperature in °C.
- N1 RPM. Fan speed in % rpm.
- N2 RPM Compressor speed in % rpm.
- EGT. Exhaust gas temperature in °C.
- FF. Fuel flow in pounds per hour.
- NOZ POS. Nozzle position in %.
- OIL PRESS. Oil pressure in psi.
- THRUST. No function.
- VIB. Engine vibration in inches per second.
- FUEL TEMP. Engine inlet fuel temperature in °C.
- EPR. Engine pressure ratio (ratio of exhaust pressure to ambient inlet pressure). EPR is a ratio of exhaust pressure to ambient total inlet pressure. On all aircraft, EPR is valid only during ground static conditions.
- CDP. Compressor discharge pressure in psia.
- TDP. No function.



Figure 26. Engine Page

**Flight Control System (FCS) Page.** The FCS page displays monitoring data of the flight control surfaces like the leading and trailing edge flaps, ailerons, rudders, and stabilator. It will also note any FCS errors noted in the four channels as "Xs". This page also displays the g limit based on aircraft gross weight.

The FCS status display may be selected on a DDI. At top center, the display presents left and right leading-edge flap (LEF), trailing edge flap (TEF), aileron (AIL), rudder (RUD), and stabilator (STAB) positions in degrees with arrows which indicate the direction from neutral. For example: the control positions shown in the figure are left LEF 1° leading edge down, right LEF 1° leading edge down, left TEF 5° trailing edge down, right TEF 5° trailing edge up, left AIL 15° trailing edge down, right AIL 15° trailing edge up, both RUD 0°, left STAB 3° trailing edge down, right STAB 4° trailing edge up. The tolerance for all control position indications is  $\pm 1^\circ$ . The numbers and arrows change as control surface deflections change. At 0° (neutral), the arrows may point in either direction. A blank is displayed where the number is unreliable.

An X through the LEF, TEF, AIL, or RUD number, also referred to as a bold X, indicates that control surface is no longer being commanded.

On either side of the position indicators are boxes which represent the FCS channels. On the left side, reading left to right, the boxes represent channels 1 and 4 for the LEF, AIL, and RUD and 1 2 3 4 for the TEF and STAB. An X in one of these boxes indicates that the FCS is no longer using that channel to command the actuator due to a failure. On the right side, reading left to right, the boxes represent channels 2 and 3 for the LEF, AIL, and RUD and 1 2 3 4 for the TEF and STAB. On the lower right side of the DDI are boxes which display the status, by channel, of the CAS pitch (P), roll (R), and yaw (Y); the stick position sensors (STICK), the rudder pedal force sensors (PEDAL); the angle of attack sensing (AOA); the backup air data sensor assembly (BADSA); and the processor (PROC); and the normal accelerometer (N ACC) and lateral accelerometer (L ACC). An X opposite one of these components indicates a failure in the channel with the X. An X opposite degraded (DEGD) indicates a switch failure or, for the TEF and STAB, a single shutoff valve failure. Flight controls are not affected but the FCS should be reset.

Except for the LEFs, the control surface position may fail to match the commanded position without indication to the aircrew.

An X in both CH1 and CH3 of PROC row indicates INS data is not being provided to the FCCs for sideslip and AOA estimation calculations. There is no significant degradation to flying qualities, departure resistance or roll performance with these failure indications. (Above approximately 30° AOA in Flaps AUTO, the FCCs use INS data for sideslip and sideslip-rate feedback to provide roll coordination and departure resistance. If INS data is not available, sideslip control, departure resistance and roll performance may be slightly degraded). The PROC X's in CH 1/3 may be caused by: an INS failure, accompanied by an INS ATT caution; by placing the ATT switch to STBY; or by an FCC-detected failure.



Figure 27. Flight Control System (FCS) Page

**Fuel (FUEL) Page.** The FUEL display, which is menu selectable, is available in-flight and on the ground. Displayed is the fuel available in each tank, total internal fuel, total internal and external fuel, and currently selected BINGO fuel. A moving caret is shown on the right side of each tank to indicate the ratio of fuel available to tank fuel capacity. The loss of valid fuel quantity information for a given tank is indicated by display of 0 pounds fuel and INV (invalid). Loss of valid information is as follows:

- All probes in a tank declared invalid by the SDC (except left or right feed tanks).
- Tank 1 aft probe invalid while forward probe reads zero fuel.
- Tank 4 forward and center probes invalid while aft probe reads zero.

An estimated (EST) fuel quantity is determined by the SDC and displayed as follows:

- Use only the valid fuel probes in a multi-probe tank to estimate fuel available.
- Fuel probe invalid in left or right feed tank:
  - Display 0 pounds if FUEL LO is present.
  - Display 800 pounds if FUEL LO is not present.

The internal fuel and total fuel indications display the sum of valid and/or estimated tank quantities. Each is cued as EST or INV as determined by the appropriate tank information with INV displayed if INV and EST both apply.

The FLBIT PB will perform a test of the FUEL LO warning system. During the test, the FLBIT label will be boxed. During the test, you should note a FUEL LO caution, a voice alert, and a MASTER CAUTION indication. The full

test takes 13 seconds. If tank two (L FD) or tank three (R FD) is already in a fuel-low state prior to BIT initiation, NO TEST will be displayed next to the respective tank indication. If tank 2 fails the BIT, tank 3 will not be tested, and NO TEST will be displayed. The FUEL LO caution will be cleared within 60 seconds of test completion.

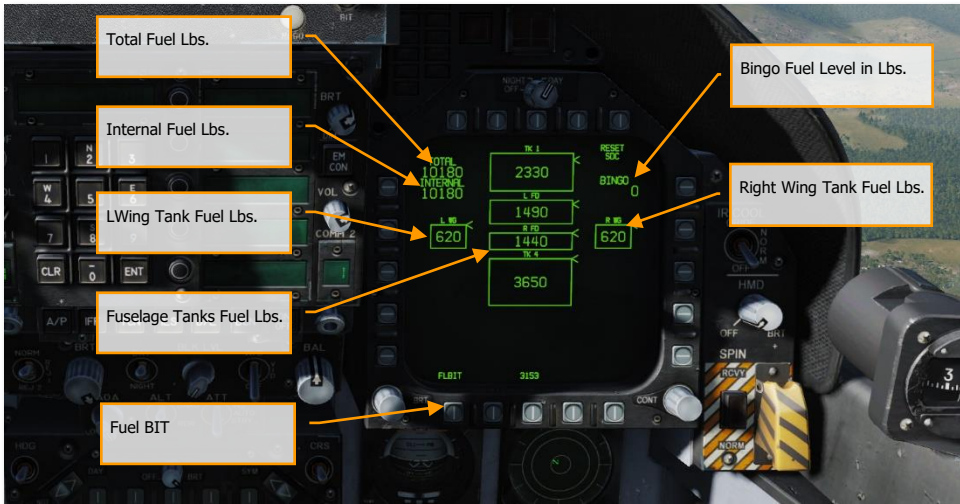

Figure 28. Fuel Page

**Electronic Attitude Director Indicator (EADI) Page.** The electronic attitude display indicator is available for display on the left or right DDI as an alternative to the attitude display on the HUD. A small circle is displayed on the ball to represent the zenith and a circle with an inscribed cross is displayed to represent the nadir. The pitch ladder is displayed in 10° increments. A turn indicator which displays FCS yaw rate is provided below the ball. A standard rate turn (3° per second) is indicated when the lower box is displaced so that it is under one of the end boxes. The EADI display is selected by pressing the ADI pushbutton on the MENU.

Selecting the INS or STBY options at the bottom of the display determines the source of attitude information used to generate the display. Upon power-up with WOW, the EADI attitude initializes to STBY (STBY boxed), thus using the standby attitude reference indicator for attitude source information. With STBY boxed the EADI display should be compared to the visual display on the standby altitude reference indicator. If the pitch and roll attitude display does not correlate on the two instruments, the standby indicator is most likely defective, requiring maintenance. Selecting the INS option (INS boxed) uses attitude information provided by the INS. Selection of the INS or STBY on the EADI does not change the source of attitude data for the HUD.

Airspeed and altitude are displayed in a box at the top left and altitude source is displayed to the right of the altitude box and the vertical velocity is displayed above the altitude box. When ILS is selected, the deviation needles are displayed in reference to the waterline symbol. The ILS needles are in yellow when COLOR is selected on the Attack display.



Figure 29. Electronic Attitude Director (EADI) Indicator

**Horizontal Situation Indicator (HSI) Page.** Mostly displayed on the MPCD, the HSI provides a top-down navigation display with your aircraft in the center. The HSI will be discussed in [F/A-18C Navigation](#).

When displayed on the MPCD, a moving map can also be projected.



Figure 30. Horizontal Situation Indicator (HSI) Page

**Flight Performance Advisory System (FPAS) Page.** The FPAS advises the pilot of the altitude and airspeed corresponding to maximum inflight fuel efficiency based on current operating conditions. The range and airspeed data provided by FPAS appears on the FPAS DDI page from the SUPT menu. The page is divided into five data areas and two select options.

- Current Range
- Current Endurance
- Optimal Range
- Optimal Endurance
- TACAN and Waypoint Navigation To
- Optimal Climb
- Home Fuel

Let's talk about each of these in reference to the image below.

**Current Range Data.** This informs you of the current range of the aircraft until only 2,000 lbs. of fuel remains. This is based on the current altitude and Mach. In the example below, this is 329 nm. When total fuel is less than 2,500 lbs., the **TO 2000 LB** changes to **TO 0 LB** and the data is in reference to zero fuel remaining. If true airspeed is above Mach .9, the range data is removed because they system is unable to calculate valid data.

Below is the data for BEST MACH and this lists the best Mach to fly to extend range at the current altitude. In the example below, this is .54 Mach.

The bottom line of CURRENT RANGE lists the calculated range if the aircraft is flown at the optimal Mach at the current altitude. In the example below, this is shown as 586 nm.



**Current Endurance Data.** The top line of the ENDURANCE indicates the time in hours:minutes the aircraft can fly at the current Mach and altitude. This is shown as 27 minutes in the image below. If total fuel is less than 2,500 lbs., the **TO 2000 LB** changes to **TO 0 LB**. If ground speed is above .9 Mach, the time is displayed as LIM (limit).

Below is the optimal Mach to fly to maximize flight endurance time at the current altitude. This is displayed as .41 Mach in the example below.

The bottom line indicates the flight endurance time if the aircraft is flown at best Mach at the current altitude. This is shown as 1 hour and 54 minutes.



Figure 31. Flight Performance Advisory System (FPAS) Page

**Navigation To Data.** Below the Current data is listed the time to reach, fuel remaining in lbs., and fuel burn rate as lbs. per nautical mile of a selected TACAN station or waypoint. From the HSI, box TCN or WYPT with a valid navigation point and the time, fuel remaining, and burn rate is automatically calculated for you.

**Optimal Range Data.** The Optimal Range shows the altitude and Mach at which to fly to achieve maximum range to 2,000 or 0 lbs. of fuel remaining. In the example above, this is shown as 37,900 feet, at Mach .84, with a range of 1,012 nm with 2,000 lbs. of fuel remaining.

**Optimal Endurance Data.** This shows the altitude and Mach to fly to achieve the maximum flight endurance time in hours:minutes to 2,000 or 0 lbs. of fuel remaining. In the example above, this is shown as flying at 33,001 feet, at Mach .71, for a maximum endurance time of 2 hours and 5 minutes.

**Optimal Climb Selection.** When the CLIMB option is boxed at pushbutton 20, the optimal climb airspeed is displayed above the airspeed box on the HUD.



*Figure 32. Optimal Climb Selection*

**Home Fuel Selection.** Using the up and down arrows on pushbuttons 16 and 17, you may designate any waypoint as the HOME location. Generally, you would want to set this as your landing waypoint. When it is calculated that 2,000 lbs. of fuel would remain upon reaching the location, the Master Caution will activate, and the HOME FUEL caution is displayed on the DDI.

## Tactical (TAC) Pages



Figure 33. Tactical (TAC) Pages

**Electronic Warfare (EW) Page.** The EW page combines the display of detected radar emitters, control of Electronic Countermeasures (ECM), and control of expendable countermeasure that includes chaff, flares, and ECM decoys.



Figure 34. EW Page

**Stores Management System (SMS) Page.** The SMS page allows you to view all loaded stores and determine their delivery properties. We will discuss this page in detail in the weapon procedure sections of this guide.



Figure 35. Stores Management System (SMS) Page

**Heads-Up Display (HUD) Page.** The HUD page duplicates what is displayed on the HUD glass at the top of the instrument panel. This is most often used when the HUD fails or is unreadable due to lighting. It can also be useful when “head down” and unable to easily check the HUD.



Figure 36. Heads-Up Display (HUD) Page

**Attack radar (RDR) Page.** See Air-to-Ground Radar and Air-to-Air Radar for details.



Figure 37. Attack Radar Page

# PROCEDURES



# COLD START

In the following sections, we will provide "How To" checklists for the primary procedures you'll need to understand to get started in the F/A-18C.

## Instant Action Mission Practice: F/A-18C Cold & Dark and Carrier Cold & Dark

There are two methods you can use to start a cold and dark F/A-18C. The first, and easiest, is the Auto-Start. By pressing **[LWin] + [Home]**, the aircraft will be started automatically for you. To cease the Auto-Start, you can press **[LWin] + [End]**.

Being a DCS title though, the F/A-18C really shines when you take advantage of the detailed systems modeling, like manually starting the aircraft. In this guide, we will skip the Pre-Flight and Upon Entering Cockpit checks and begin with the Before Engine Start checks.

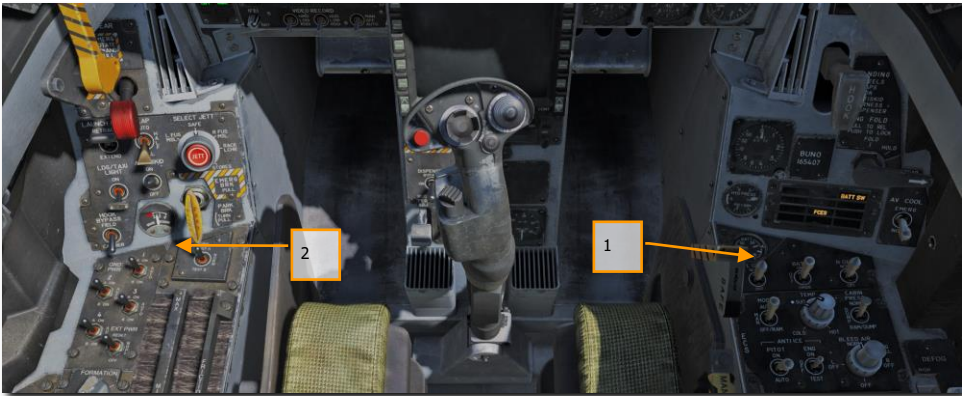

1. Set the BATTERY switch to ON and confirm both Left and Right Generators are ON. [\[RIGHT CONSOLE\]](#)
2. Move and hold the fire detection switch to FIRE TEST A and wait for all the audio caution messages to play. Once complete, wait 10 seconds and then do the same for FIRE TEST B. Between running FIRE TEST A and FIRE TEST B, you can reset the battery switch to rewind the fire test tape. [\[LEFT CONSOLE\]](#)

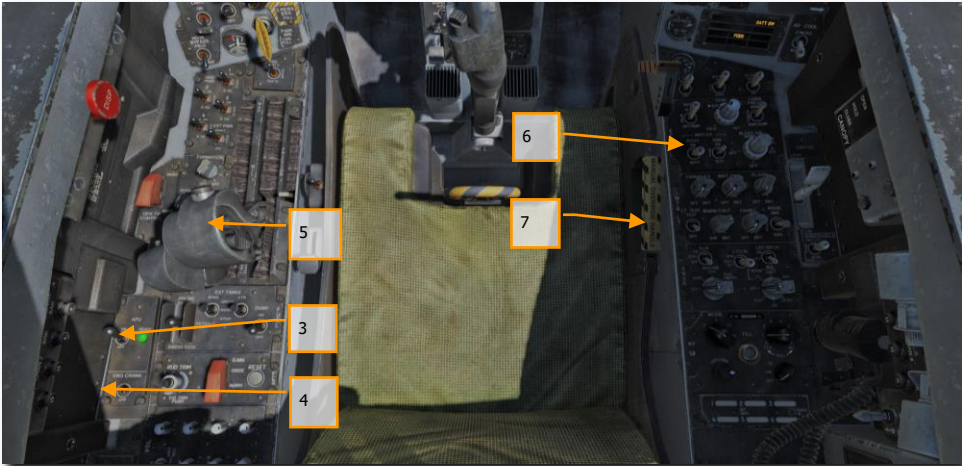

3. APU switch to ON and wait for green APU READY light. [LEFT CONSOLE]
4. Move the ENG CRANK switch to the right to start the right engine. [LEFT CONSOLE]
5. Move the right throttle from OFF to IDLE when the right engine is above 25% rpm (as shown on IFEI). [RShift] + [Home]
6. Once right engine RPM is over 60%, rotate the BLEED AIR knob 360° clockwise, from NORM to NORM. [RIGHT CONSOLE]
7. Test the CAUTION, WARNING and ADVISORY lights test. [RIGHT CONSOLE]
8. Turn on the power to both DDIs, MPCD and HUD. Select the FCS page on the left DDI and the BIT page on the right DDI. [INSTRUMENT PANEL]

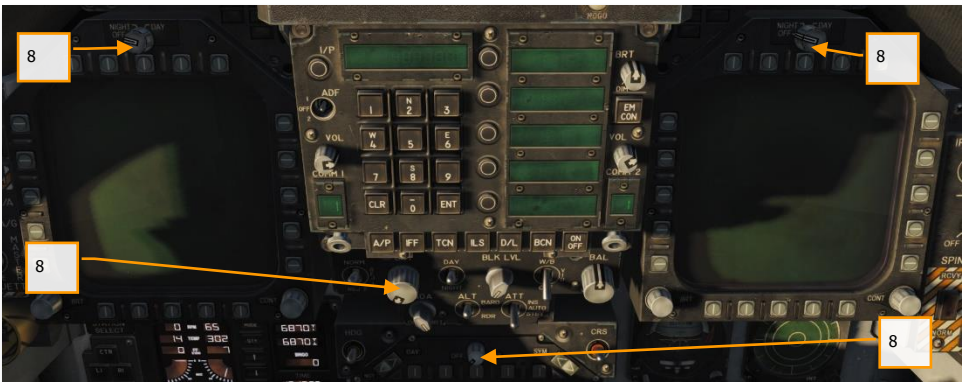

9. Set COMM 1 and COMM 2 radios as required for the mission.





- 10. Move the ENG CRANK switch to the left after confirming that the right engine has an rpm between 63 and 70%, a TEMP between 190° and 590°, Fuel Flow between 420 and 900 PPH, a nozzle position between 73 and 84%, and an OIL pressure between 45 and 110 psi. [\[LEFT CONSOLE\]](#)



- 11. Move the left throttle from OFF to IDLE when left engine has reached at least 25% rpm by pressing [\[RAIt\] + \[Home\]](#). [\[THROTTLES\]](#)



12. Once the left engine has an RPM greater than 60%, rotate the INS knob to GND (ground) or CV (carrier), depending on your parking location. [\[RIGHT CONSOLE\]](#)
13. Set the Radar knob to OPR (operate). [\[RIGHT CONSOLE\]](#)

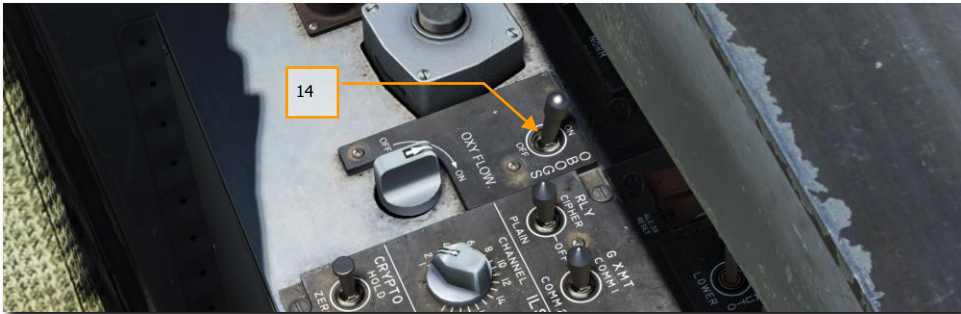

14. Set the OBOGS control switch and FLOW switch to ON. [\[LEFT CONSOLE\]](#)



15. Press the FCS RESET button and monitor FCS DDI page. [LEFT CONSOLE]
16. Set the Flap switch to AUTO. [LEFT QUARTER PANEL]
17. Press Takeoff Trim button. [LEFT CONSOLE]
18. While holding up the FCS BIT switch [Y] on the right wall, press the FCS OSB on the BIT / FCS page at the same time.



19. Four down test. Cycle / test the refueling probe, speed brake, launch bar, arrestor hook, pitot heat, and set flaps to HALF. [LEFT CONSOLE, THROTTLES, LEFT QUARTER PANEL, RIGHT QUARTER PANEL, AND RIGHT CONSOLE]
20. Left mouse click on the hand brake to release it.

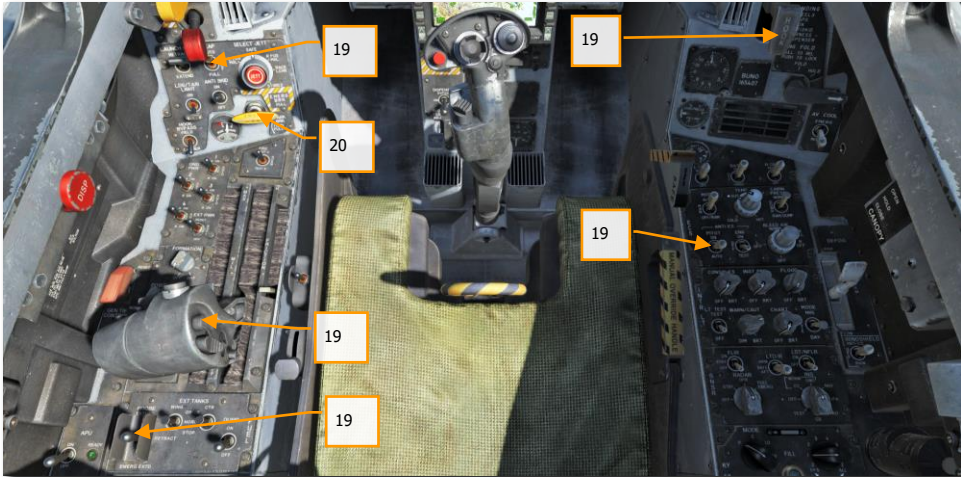

21. Set your BINGO fuel level (minimum fuel to return home) by pressing the up and down arrows on the IFEI. [LEFT INSTRUMENT PANEL]
22. Set the Standby Barometric Altimeter to airfield elevation. [RIGHT INSTRUMENT PANEL]
23. Set the Radar Altimeter to 200 feet for an airfield takeoff or 40 feet from the carrier. [RIGHT QUARTER PANEL]
24. Uncage the standby Attitude Indicator. [RIGHT INSTRUMENT PANEL]
25. Set the Attitude Source to AUTO. [CENTER INSTRUMENT PANEL]



If you plan to use the Joint Helmet Mounted Cueing System (JHMCS), you will need to align it now. To do this, follow the steps in HMD Alignment under the JHMCS chapter.

# AIRFIELD TAXI

1. Whether you have completed a cold start or are starting the mission in a "hot" aircraft, your next step will be to taxi to the runway. Slowly advance the throttles **[PgUp]** and use the rudder pedals to steer left **[Z]** and right **[X]**. Reduce throttle by pressing **[PgDn]**. Holding down the Noses Wheel Steering (NWS) button, you can enable NWS HI mode enabled tighter taxi turns. Press **[W]** to apply wheel brakes.
2. Set the left DDI to the checklist page and the right DDI to the FCS page.
3. At the hold short before entering the active runway:



4. Arm the ejection seat. **[RIGHT CONSOLE]**
5. Close the canopy if you have not already done so. **[LCtrl] + [C]**
6. Set the left DDI to the HUD page. **[LEFT INSTRUMENT PANEL]**

# AIRFIELD TAKEOFF

## Instant Action Mission Practice: F/A-18 Takeoff

1. Align the aircraft down the center of the runway and roll forward to align the nosewheel down the runway.
2. Set left DDI to the HUD page.
3. Advance to throttles to afterburner.
4. Use nosewheel steering to maintain a straight track down the runway.



5. At nosewheel rotation speed, hold the control stick back until 6° to 8° nose high attitude (water line above the horizon line on the HUD)
6. Raise the landing gear and set the FLAP switch to AUTO once positive climb is established.
7. Switch the right DDI to air-to-air radar.

# AIRFIELD VFR LANDING

## Mission Practice: F/A-18C Airfield VFR Landing

As a carrier-capable aircraft, the F/A-18C can land on both "the boat" and airfields. Both landing patterns are quite similar. For this guide though, we will just review the procedure for landing at an airfield under Visual Flight Rules (VFR) conditions.

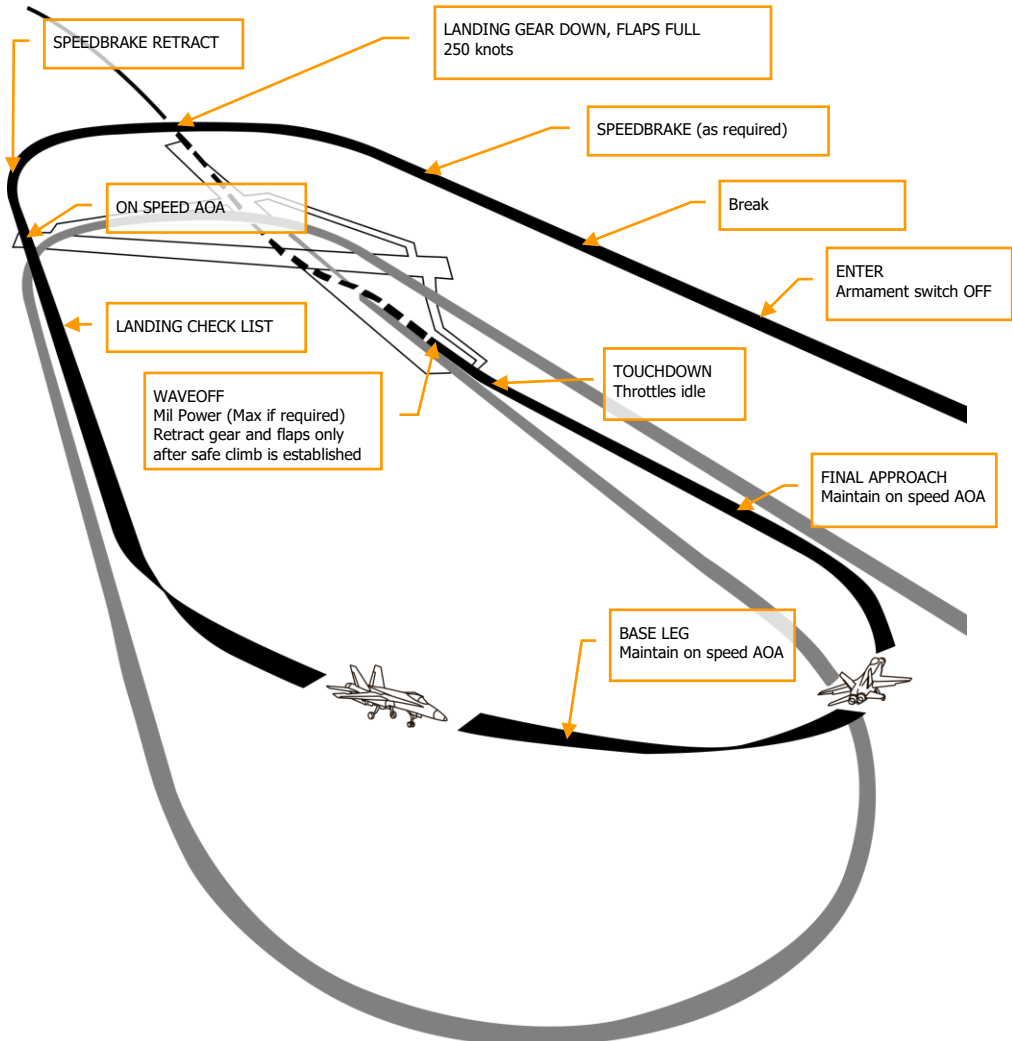
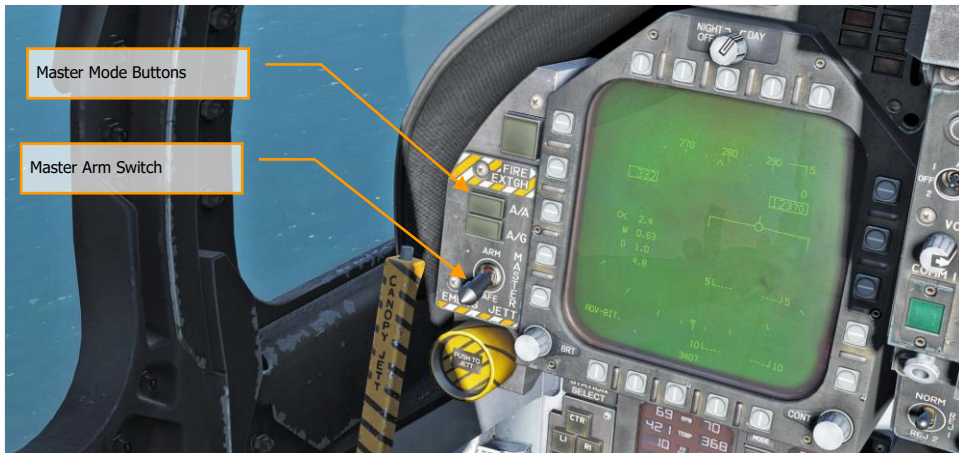

Figure 38. Airfield Landing Pattern



Call up the air-to-air radar page on your right DDI and HUD repeater on your left DDI.

Enter Navigation master mode and set the Master Arm Switch to SAFE on the [LEFT INSTRUMENT PANEL] and approach at 350 knots and 800 feet Above Ground Level (AGL) along the heading of the landing runway and offset yourself slightly away from your first turn into the pattern.



Five to ten seconds after your wingtip passes the end of the runway (the greater the time, the more time you must establish your on-speed AoA on the downwind leg), turn into the downwind leg of the landing pattern. Generally, pull 1% of your airspeed in g. For example: 350 knots would equal 3.5 g. Roll out on a reciprocal landing heading and an altitude of 600 feet AGL.

Your lateral offset from the runway should be about 1.2 miles.

Once your airspeed is below 250 knots, lower your landing gear and place your flaps in the FULL down position. [LEFT QUARTER PANEL]



Allow your airspeed to decay until you reach your on-speed angle of attack as indicated left of the HUD on the Angle of Attack Indexer. This will equate to  $8.1^\circ$  of angle of attack which will appear as the yellow circle on the AoA Indexer. On the HUD, the Velocity Vector should be centered in the AoA "E" Bracket. Establish your on-speed AoA at 600 feet AGL.

You will need to trim the aircraft to  $8.1^\circ$  AoA to be hands-free.



Turn into the landing base leg when your wing tip aligns with the runway threshold while maintaining on-speed AoA. Your bank angle should be  $30^\circ$  and the HUD velocity vector should be just below the HUD horizon line. You will need to slightly increase throttle to maintain this AoA. Continue the on-speed descending turn until you are aligned with runway landing heading (a good idea is to set your course line to the landing airfield along the landing runway heading).

Maintain on-speed AoA with the HUD velocity vector placed 500 feet past the runway threshold. Use your throttle to maintain a  $3^\circ$  flight path.

At touchdown, reduce the throttles to idle and use small rudder corrections to stay aligned down the runway roll-out.

# AIRCRAFT CARRIER TAXI

## Mission Practice: Carrier Cold and Dark

After completing start up on the carrier, your next task will be to taxi to the catapult for takeoff. The primary difference between an airfield start-up and an aircraft carrier startup will be placing the INS switch in the NORM CVN position for alignment.

Set the left DDI to the checklist page and the right DDI to the FCS page.

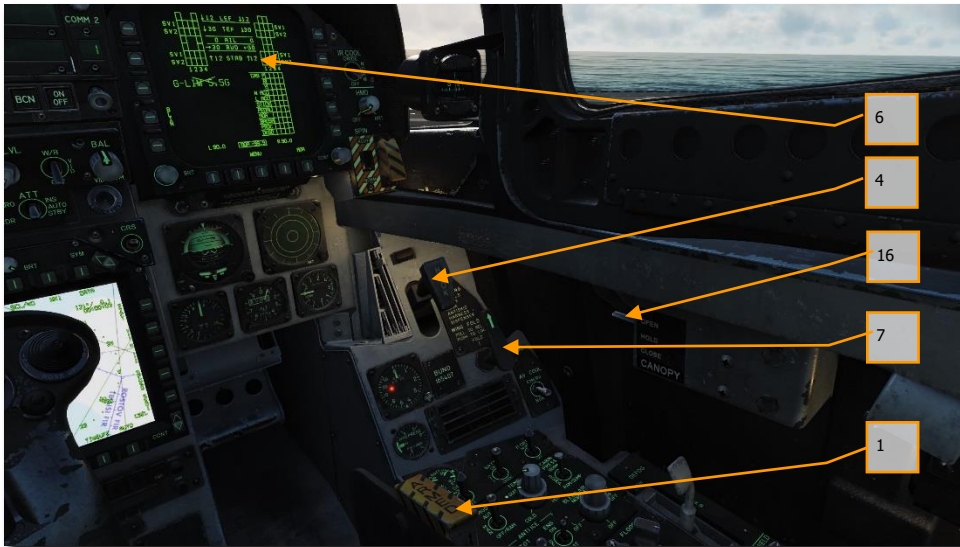

Your complete checklist prior to taxi includes:

1. Arm the ejection seat
2. Check that nosewheel steering is on
3. No warning lights
4. Hook is up
5. Flaps are set to HALF
6. Trim set to total aircraft weight
7. Wings match wing fold handle
8. Oxygen on
9. Brake off
10. Launch bar up
11. Anti-skid off
12. Master Arm off
13. From the MPCD, select WTPT and cycle the waypoint to 1.
14. Countermeasures off
15. Radar altimeter to 40 feet

16. Canopy closed
17. Master external light switch aft

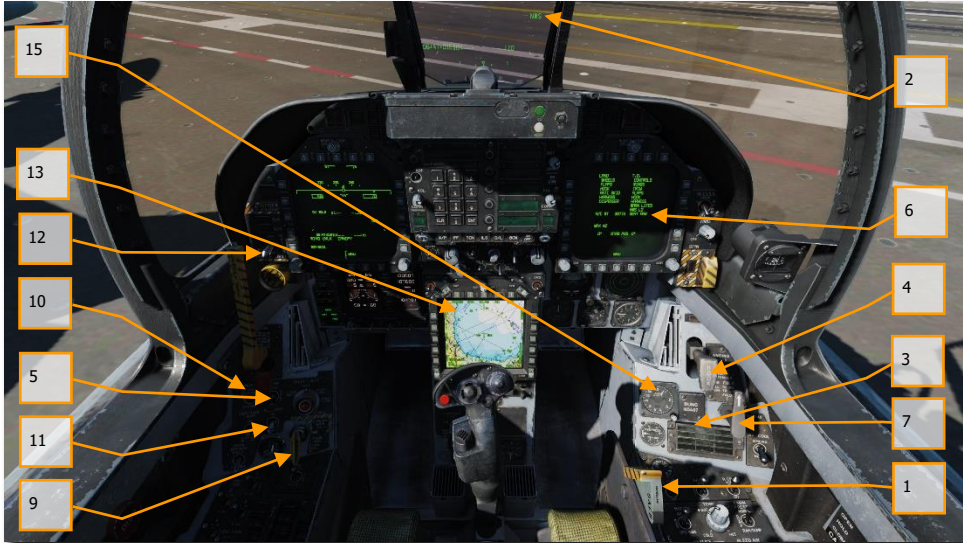

Taxi to the directed catapult using small power inputs while using nosewheel steering in high gain **[S]**. Once behind the Jet Blast Deflector (JBD) of the catapult you will launch from, spread the wings using the wing fold handle on the right vertical panel. To do so, right mouse button click on the handle until at the SPREAD setting. Then, with the mouse cursor over the handle, rotate forward on the mouse wheel.

Slowly advance the throttles **[PgUp]** and use the rudder pedals to steer left **[Z]** and right **[X]**. Reduce throttle by pressing **[PgDn]**. Holding down the Noses Wheel Steering (NWS) button, you can enable NWS HI mode **[S]** enabled tighter taxi turns. Press **[W]** to apply wheel brakes.



Slowly move forward of the JBD and align your nosewheel along the catapult track. You can best align yourself by using either the **[F2]** external view or taxi to place the shuttle directly left or right of your shoulder when launching from catapult 1 or 2. Once the nosewheel is directly behind the catapult shuttle, lower the launch bar. Next, press **[U]** and this will auto-connect the launch bar to the catapult shuttle.

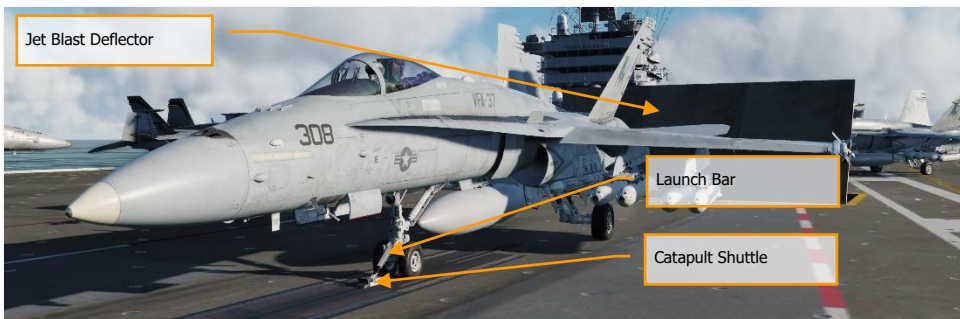

Once hooked up, takeoff stab position with the trim hat based on total aircraft weight. This weight can be seen on the CHECKLIST page. Using the TRIM HAT, set your stabs to takeoff trim based on:

- Below 44,000 gross weight = stab trim 16° (MIL or burners)
- 45,000 to 48,000 gross weight = stab trim 17° (MIL or burners)
- 49,000 and above = stab trim 19° (Burners required)



With stabs set to total takeoff weight, you will be ready for launch.

# AIRCRAFT CARRIER LAUNCH

## Mission Practice: Carrier Takeoff

1. Set throttles to military power and wipe the controls by moving control stick in a full circle and then push full forward and back. Then, push both full left and right rudder.
2. Increase throttle to 100% afterburner and move hand off stick.
3. The catapult will then launch you and place you at flyaway trim.
4. After positive climb rate has been established, raise the landing gear [G] and set flaps to AUTO [F].
5. If launching from catapult 1 or 2 (bow catapults), perform a clearing turn to the right and then proceed parallel along the carrier BRC for 7 miles at no more than 500 feet / 350 knots. If launching from catapult 3 or 4 (waist catapults), perform the clearing turn to the left.

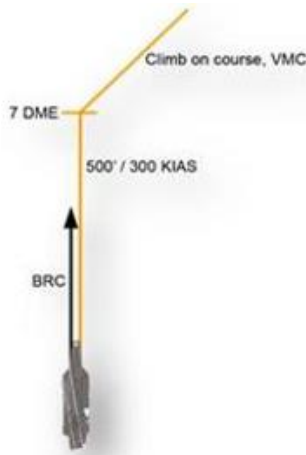

6. Set right DDI to the A/A attack radar display.

# CASE 1 CARRIER RECOVERY

## Instant Action Mission Practice: Case I Carrier Landing

Landing on aircraft carrier in Case I conditions is much like an airfield in VFR conditions. A Case I condition is defined as visibility of at least 5 miles and clouds no lower than 5,000 feet. In other words, good weather, day light conditions.

Call up the air-to-air radar page on your right DDI and HUD repeater on your left DDI.

Enter Navigation master mode and set the Master Arm Switch to SAFE on the [\[LEFT INSTRUMENT PANEL\]](#). Lower the arrestor hook by pressing [\[H\]](#) and set HUD altitude to radar.

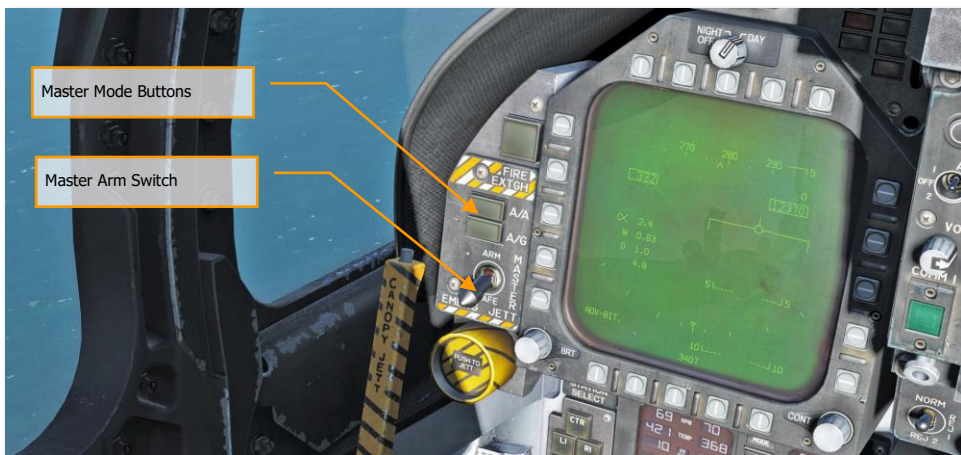

Entry into the Case I pattern would either be done from a port holding pattern (5 nm diameter circle at 1.5 to 5 thousand feet over the carrier) or a direct approach into the upwind leg. In this guide, we will discuss a direct approach.

*Note: For a Case 1 recovery, neither TACAN nor ICLS are required. Those will be discussed in Case II and III recoveries.*

Approach the carrier from astern at 800 feet and 350 KIAS. Pass starboard of the carrier, and just close enough that you can look down to the left and visually spot the carrier deck to make sure the deck is not foul.



At no more than 1.5 nm after passing the bow of the carrier, initiate a level turn to the left.



Generally, pull 1% of your airspeed in g. For example: 350 knots would equal 3.5 g. Roll out on a reciprocal landing heading and an altitude of 600 feet AGL. If your entry speed is above 350 KIAS, you may wish to extend the airbrake until your airspeed decays to 250 KIAS. Once below 150 KIAS, lower the landing gear [G] and extend flaps to FULL [LCtrl] + [F].

Your lateral course distance from the carrier in the downwind leg should be 1.3 to 1.4 nm. See the TACAN Navigation chapter.



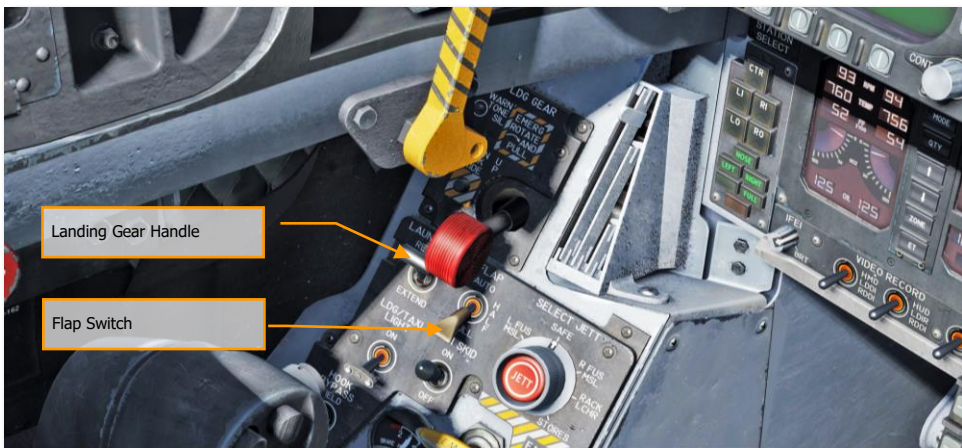

With an established altitude of 600 feet, keep letting airspeed fall until around 145 KIAS and carefully increase throttle such that you capture the on-speed AoA as indicated by the E-Bracket on the HUD and the Angle of Attack Indexer lights to the left of the HUD frame.



Maintain on-speed AoA and 600 feet until the round-down on the stern of the carrier is visible and forms a straight line.



In the first 90 degrees of the second turn, maintain on-speed AoA and use throttle to adjust your decent rate between 100 and 200 feet per minute with a roll angel of 27° to 30°. A good way to visualize this is to place the velocity vector just below the horizon line on the HUD such that just the vertical post and right "wing" touch the horizon line.

During this portion of the turn, don't peek at the carrier, instead fly by the instruments.

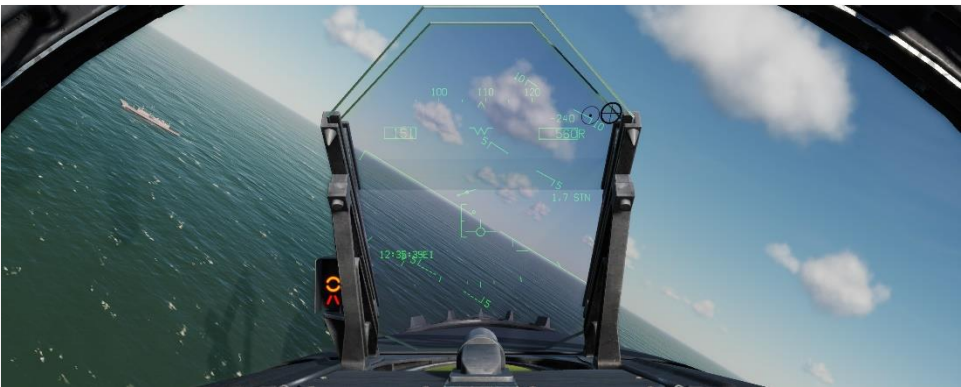

As you pass the second 90 degrees of the second turn, allow your vertical velocity to increase to 500 feet per minute and visually acquire the carrier and Improved Fresnel Lens Optical Landing System (IFLOLS).

Upon rolling out on final approach to the carrier, all direction is now dictated by the IFLOLS.

An optical landing system (OLS) provides the pilot with glidepath information during the final phase of the approach. The first OLS utilized a gyroscopically controlled concave mirror. This mirror was vertically mounted between two horizontal sets of green datum lights. An orange source light was shown in the mirror and would appear as a yellowish orange "ball" to the pilot.

The position of the ball relative to the datum lights would indicate the relative position of the aircraft to the desired glidepath. If the ball was above the datum lights (a high ball), the aircraft was above the glidepath; conversely, a low ball indicated the aircraft was below glidepath. When the ball and the datum lights were aligned horizontally, the aircraft was on glidepath.

The IFLOLS consists of a lens assembly, "cut" lights, waveoff lights, and datum lights. The IFLOLS has three modes of stabilization: Line, Inertial, and Point. Line Stabilization compensates for the ship's pitch and roll. Inertial Stabilization operates the same as Line Stabilization, but also compensates for the up and down motion (heave) of the flight deck. Both modes stabilize the glideslope to infinity. The point stabilization mode fixes the glideslope around a point 2500 feet aft of the lens. The system is normally set for a 3.5° glideslope targeting the 3-wire. The IFLOLS comes in both the shore-based and ship-based variants.

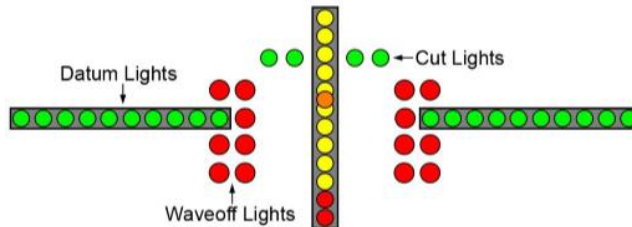

- Lens Assembly.** The lens assembly is a box that contains 12 vertical cells through which fiber optic light is projected. The upper cells are amber in color while the bottom two are red. The aircraft's position on the glidepath determines which cell is visible to the pilot. The visible cell, compared to the horizontal green datum lights, indicate the aircraft position relative to the glideslope (i.e., above, on, or below the optimum glideslope). If a red lens is visible, the aircraft is dangerously low.
- Cut Lights.** Mounted horizontally and centered above the lens box are four green cut lights. The cut lights are used by the LSO to communicate with the aircraft during Zip Lip or Emissions Controlled (EMCON) operations. As the aircraft approaches the groove, the LSO will momentarily illuminate the cut lights to indicate a "Roger ball" call. Subsequent illumination of the cut lights indicates a call to add power. Zip Lip is normally used during day Case I fleet operations to minimize radio transmissions. EMCON is a condition where all electronic emissions are minimized.
- Waveoff Lights.** Waveoff lights are mounted vertically on each side of the lens box. These red lights are controlled by the LSO. When they are illuminated, the aircraft must immediately execute a waveoff. The LSO will initiate a waveoff any time the deck is foul (people or equipment in the landing area) or an aircraft is not within safe approach parameters. "Bingo" is signaled by alternating waveoff and cut lights.
- Datum Lights.** Green datum lights are mounted horizontally to the lens assembly with ten lights on each side. The position of the ball in reference to the datum lights provides the pilot with glideslope

information. If the ball is illuminated above or below the datums, the aircraft is high or low respectively

Upon the main gears contacting the landing area, immediately move the throttles to full power in case the arrestor hook misses the wires. This will allow the aircraft enough power to get airborne again.

If the "trap" is successful, retard the throttles to idle, raise the arrestor hook [H], set flaps to AUTO [F] and taxi out of the landing area.

# NAVIGATION

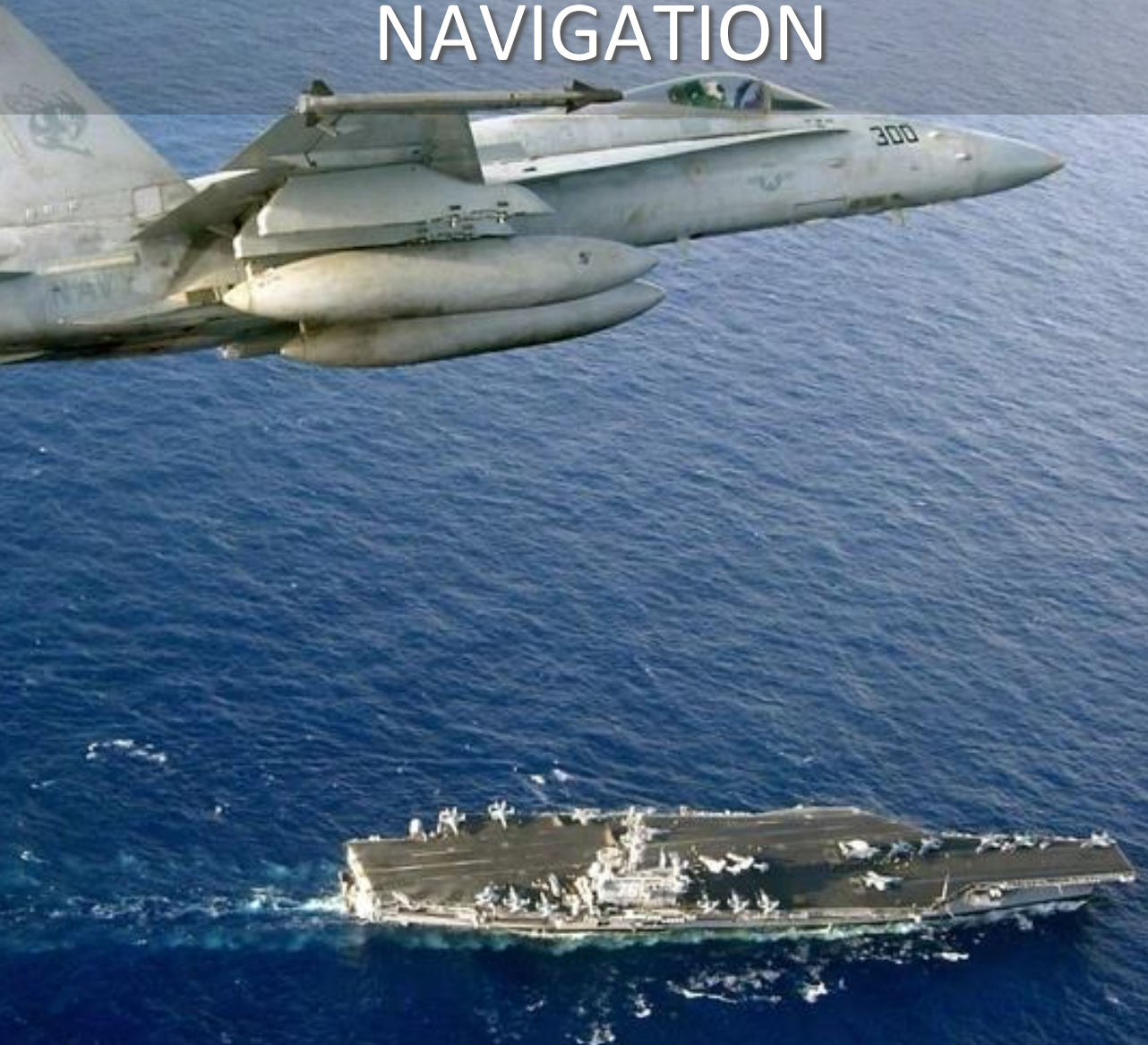

# NAVIGATION

The F/A-18C has three master modes of operation: Navigation (NAV), Air-to-Air (A/A), and Air-to-Ground (A/G). The displays and avionics equipment operations are tailored as a function of the selected master mode. A/A master mode is entered by either pressing the A/A master mode button or by selecting an A/A weapon with the Weapon Select Switch. When A/A is selected, the radar display is placed on the right DDI, and the Stores Management System (SMS) display is placed on the left DDI. A/G master mode is selected by pressing the A/G master mode button. When neither master button is enabled (neither button lit), the F/A-18C is in the NAV master mode.

## Mission Practice: F/A-18C VFR Navigation

Before using the F/A-18C navigation system, enable the system by placing the INS knob on the Sensor Panel to the NAV position. [\[RIGHT CONSOLE\]](#)

Navigation systems of the includes an Inertial Navigation System (INS), Tactical Air Navigation (TACAN), Automatic Direction Finding (ADF), and Instrumented Carrier Landing System (ICLS). Together, these systems provide accurate navigation day or night and in all weather conditions. The primary navigation indicator is the Horizontal Situation Indicator (HSI) which is most often displayed on the central MPCD. A moving map can also be enabled with full-color capability on the MPCD, but not available on either DDI. The UFC is used for navigation data entry.

The primary methods of navigation are the TACAN mode which provides steering to navigation beacons and Waypoint based navigation points created in the Mission Editor or while in the cockpit. Both modes provide DATA pages for each TACAN station or waypoint, bearing and range to the location, time to reach the location, and various steering aids.

## INS Alignment

The navigation system can be aligned by a variety of methods on the ground or in the air. This is started by positioning the INS Mode Select knob on the Sensor Control panel to the desired position. The INS knob is usually set to IFA when the alignment is complete.

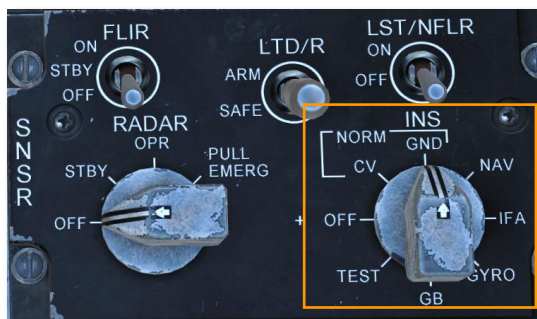

**CV (Carrier Alignment).** This is the primary alignment mode onboard an aircraft carrier.

**GND (Ground Alignment).** This is the primary alignment mode on an airfield.

**NAV (Inertial Navigation).** This operational mode is used on aircraft without Global Positioning System (GPS) equipment installed.

**IFA (Aided INS / Inflight Alignment).** In Aided INS (AINS) Mode, the INS and GPS data is integrated to provide the best navigation data. This is the primary operating mode for aircraft with GPS. This selection also enables an Inflight Alignment mode if alignment is lost during flight.

## Alignment Procedure

A full INS alignment should be accomplished prior to every flight. This is normally begun just after engine start and avionics power-up to allow time for the full alignment to complete prior to taxi.

1. Verify the Parking Brake is set.

Releasing the parking brake before alignment is complete may result in an invalid alignment. The alignment will need to be reinitialized.

2. INS Mode Selector Knob - GND on an airfield or CV on a carrier.

The alignment status may be monitored on the HSI page.



**Alignment Type.** This identifies the alignment mode being used. Possible types include GRND (ground alignment), CV RF (carrier alignment with position datalinked from ship), CV CBL (carrier alignment with position provided by cable from ship), CV MAN (carrier alignment with position manually entered).

**Alignment Quality.** Initially, NO ATT will be displayed as the INS is calibrated for level. After calibration, a number estimating the accuracy of the present position is displayed. When an acceptable level has been reached, OK is displayed next to the QUAL number.

**Time into Alignment.** This starts to count up when the alignment begins.

**Stored Heading Option.** Selecting Stored Heading after the alignment begins may allow a faster INS alignment in certain situations. This can be useful for "scramble" missions or for situations when your play time is limited.

This alignment assumes a full gyrocompass alignment was already performed before the aircraft was last shut down and the aircraft has not been moved. The previously computed true heading is stored and used to give the alignment process a head start. The alignment then progresses as with a normal alignment.

3. Monitor alignment progress and switch INS knob to IFA (with GPS) or NAV (without GPS) when OK is displayed.



### *How to Navigate Using Waypoints*

1. Select HSI from the SUPT DDI page
2. Select the WYPT Option Select Button
3. Use the Up and Down arrows to select waypoint as indicated between the arrows
4. Fly to the waypoint based on HSI and HUD command steering indicators

Regardless of navigation method, the HSI has the following options and indicators. Option buttons for the main HSI include:



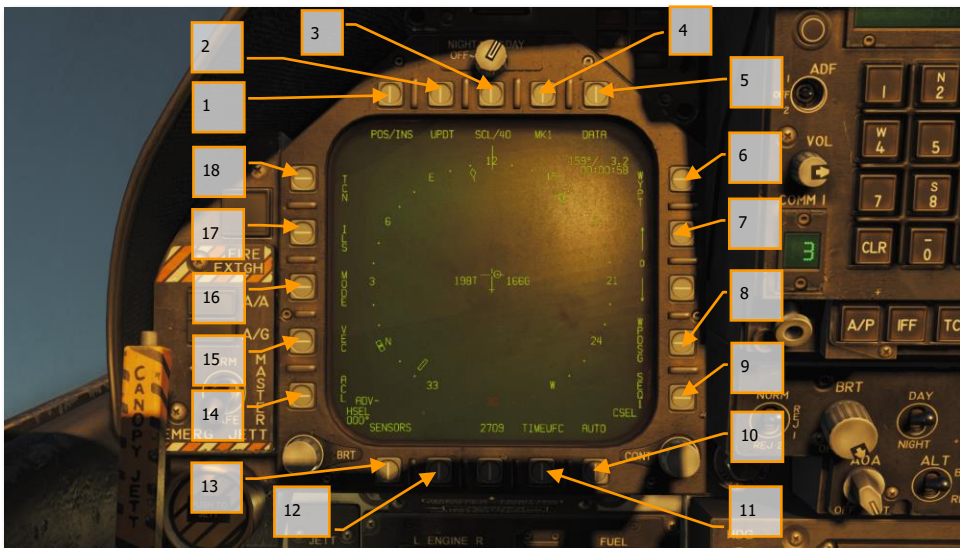

Figure 39. HSI Option Buttons

1. **POS/XXX Option.** The POS Option button determines the position keeping source. Pressing this Option Button displays the four options along the top of the DDI with an HSI option button to return to the main HSI page without making a change.



Figure 40. Position Keeping Source Selection

- **AINS.** The inertial navigation system (aided by the GPS) is used as the navigation source.
  - **TCN.** The active TACAN is used as the navigation source. The TACAN's position must be in the onboard TACAN database (see TCN (TACAN) Sublevel).
  - **ADC.** The air data computer and attitude heading reference system (ADC and AHRS) are used as the navigation source. This is a backup mode that is used when the INS fails. Accuracy degrades steadily over time.
  - **GPS.** The GPS is used as the navigation source directly, without reference to the INS.
2. **UPDT Option.** Performs a preset position update. (N/I)

3. **SCL Option.** This options allows selection of the range scale of the HSI. Successive presses of this button select and then wrap ranges of 5, 10, 20, 40, 80, and 160 miles. The selected scale is indicated right of the SCL legend.
4. **MK Option.** Pressing the MK option button saves a markpoint at the location of the aircraft when the button was pressed. Up to nine markpoints can be created. After the ninth, the first markpoint will be over-written, and so forth.
5. **DATA Option.** With either TCN or WYPT selected as the navigation method, pressing the DATA button will display a sublevel with additional information about the aircraft, selected TACAN and selected Waypoint. See DATA section below.
6. **WYPT Option.** When selected and box, steering information is presented regarding the selected waypoint. See Waypoint Navigation.
7. **Waypoint / Markpoint Selection.** The number between the two arrows is the selected waypoint, and the up arrow selects the next waypoint in the waypoint sequence and the down arrow selects the previous waypoint. At the end of the waypoint sequence, markpoints are available in sequence.
8. **WPDSG Option.** Pressing the WPDSG designates the current navigation point as a target waypoint (TGT). When a waypoint is designated as a target, the WPDSG legend is removed and the WYPT legend changes to TGT. HUD symbology also reflects the change to be a target location.
9. **SEQ # Option.** When selected and boxed, all waypoints of the sequence are displayed on the HSI and dashed lines connect them in sequence. Successive presses of this button cycle through the sequences. The F/A-18C can store three sequences. See Waypoint Navigation.
10. **AUTO Option.** When selected and boxed, automatic sequence steering to the next waypoint is enabled. WYPT must be selected as the navigation method.
11. **TIMEUFC Option.** Selecting this option allows time selection options from the UFC. These include SET, ET (elapsed time) and CD (count down). Upon selecting (boxing) this option button, the UFC lists the time options to display on the HSI and HUD.



Figure 41. TIMEUFC Options on UFC

**SET.** Displays the date.

**ET.** Starts incrementing time in minutes and seconds up to 59:59. Press the UFC ENT button to start the counter and successive presses of the ENT button will pause and start the counter.

**CD.** The countdown timer starts to decrement time in minutes and seconds, starting from 06:00. Upon selection of the CD option, pressing the ENT button starts the timer and successive presses of the ENT button pauses and start the counter.

**ZTOD.** When selected, the Zulu time of day is displayed.

**LTOD.** When selected, the local time of day is displayed. (N/I)

*Note that ET and CD are mutually exclusive and ZTOD and LTOD are mutually exclusive.*

12. **MENU Option.** Displays the TAC menu page.
13. **SENSORS Option.** When enabled, aerial targets detected by the radar in range and azimuth are displayed on the HSI. (Coming later in early access)
14. **ACL Option.** Automatic carrier landing (ACL) is selected as the navigation method. (N/I)
15. **VEC Option.** LINK 4 Vector is selected as the navigation method. (N/I)
16. **MODE Option.** Pressing the MODE option button displays sublevel options along the left side of the HSI. These include T UP (HSI is oriented to the flight track is always pointed towards the top of the HSI display), N UP (true north is always at the top of the display), DCTR (de-center placed the aircraft symbol at the bottom of the display), MAP (enable or disable moving map), and SLEW (N/I).
17. **ILS Option.** ICLS is selected as the navigation method. (N/I)
18. **TCN Option.** TACAN is selected as the navigation method. See TACAN Navigation.

# WAYPOINT NAVIGATION

Waypoint navigation consists of a series of navigation points to create a navigation sequence. This allows point-to-point steering along the sequence using automatic (AUTO) sequencing. Any waypoint can also be designated as a target point (TGT) using the WPDSG option. Additionally, up to nine markpoints can be created that can also act as waypoints. Command heading, distance, and time to reach the selected waypoint is provided on the HSI Waypoint Data Block and HUD.

Waypoint steering is selected by pressing the WYPT option button on the right side of the HSI. Below are increment and decrement arrows to select the steer-to waypoint as indicated between the arrows.

In the top right of the HSI, the bearing to, distance to and time remaining to reach the selected waypoint are displayed in the Waypoint Data Block. Inside the compass rose, the waypoint bearing indicator and waypoint symbol provide heading steering information.

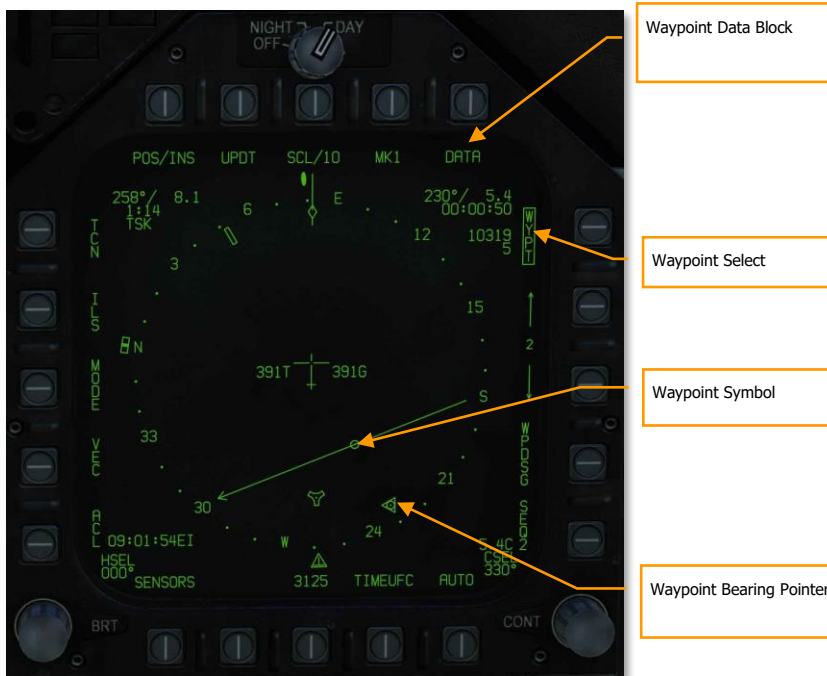

Figure 42. HSI Waypoint Steering

Additional waypoint steering is provided on the HUD.



Figure 43. Waypoint Steering on HUD

While in waypoint navigation steering and a waypoint selected, the WPDSG (waypoint designate) option button on the right side of the HSI can be pressed to change the selected waypoint to a target point. On the HUD, the target appears as a Target Designation diamond.



Figure 44. Waypoint as Target on HUD

## Time on Target (TOT) Navigation

Often in combat operations, it is vital to hit your target at a precise time in order to best coordinate with other friendly forces. Based on a Time on Target, or TOT, using Zulu time, the F/A-18C can provide you guidance to reach your target at the entered TOT.

To do so, following these steps:

1. Select Horizontal Situation Indicator (HSI) page from any display and then select the DATA / WYPT page. Along the bottom portion of the DATA page are blank fields for the desired time on target Zulu time, the ground speed from the initial point to the target point, and the waypoint that will serve as the target from which the TOT will be calculated.

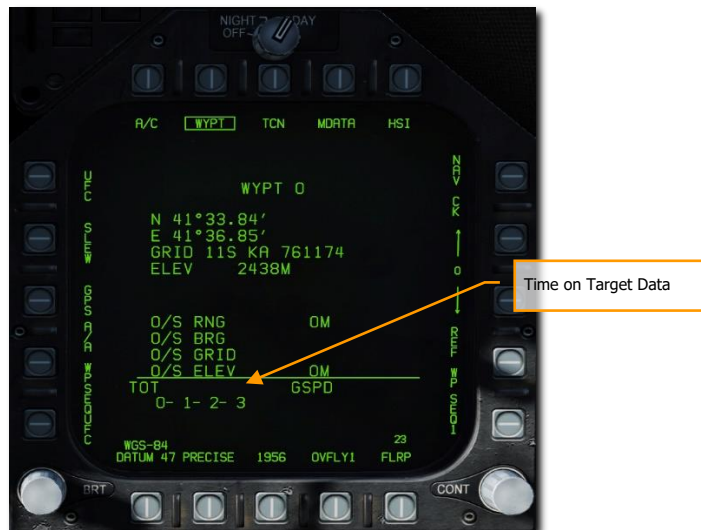

Figure 45. Time on Target Data Fields

2. **TOT Entry.** First, we will enter the desired TOT. To do so, first press the WPSEQ UFC pushbutton 1. This will then display GSPD (ground speed), TGT (target), and TOT (time on target) in the top three Option Select Windows. Upon pressing the TOT Option Select Button, the TOT indication on the Option Select Window will be colonized. Using the UFC Keypad, enter the hour:minute:second for the TOT based on Zulu time. The format is HH:MM:SS, and once you then press the ENT button on the UFC, the set TOT will then be displayed on the DATA / WYPT page.

*Note that current Zulu time is generally displayed in the bottom left corner of the HUD.*



Figure 46. Time on Target Data Entry

3. **GSPD Entry.** Next, we will enter the airspeed in calibrated knots that the aircraft will fly the leg between the Initial Point (waypoint before the target point) and the target point that will also serve as the TOT point. Select GSPD from the UFC Option Select Window to colonize it, and then enter the desired airspeed using the UFC keypad. Upon then pressing the ENT button on the UFC, the GSPD value on the DATA / WYPT page will be filled in.



Figure 47. Ground Speed Data Entry

4. **TGT Entry.** The final step is to designate the waypoint that will act as the target point from which the TOT will be calculated. Along the bottom of the DATA / WYPT page, the waypoints that comprise the selected sequence are listed. As before, select TGT from the UFC Option Select Window to colonize it and then use the UFC keypad to enter the number of the desired waypoint and then press the UFC ENT button. This will then box (set) the selected waypoint in the sequence.



Figure 48. Target Data Entry

With all elements set for a TOT calculation, a caret will appear below the airspeed box on the HUD, with a vertical line centered below the box. This is your early/late indication. If the caret is left of the line, you are too slow and must speed up to meet the TOT. If however the caret is to the right of the line, you are too fast and must slow down to meet the TOT. Ideally, you want the caret centered on the line to meet your TOT.



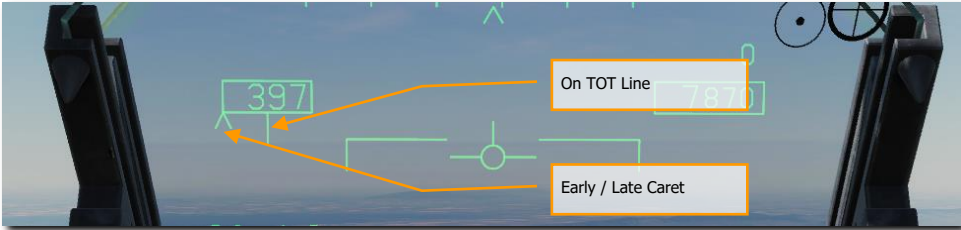

Figure 49. Time on Target HUD Indication

## Modifying a Waypoint

During a mission, you may find the need to modify an existing waypoint, the most common being an adjustment of the waypoint's elevation to match the ground elevation. To do so, select the HSI / DATA / WYPT page and note the chain of waypoints listed at the bottom of the page that comprise the waypoints of the selected sequence. For example: 0-1-2-3-4-5-6

By pressing pushbutton 5, the UFC Option Select Windows display POSN (position), ELEV (elevation), GRID, and O/S (offset). To select a waypoint to modify, use the up (pushbutton 12) and down (pushbutton 13) arrows.

- POSN. By selecting Position, you may enter the Latitude and Longitude using the UFC keypad.
- ELEV. Once the Elevation option is selected, you can enter a new waypoint elevation in either feet or meters.
- GRID. This option lets you enter a waypoint position in MGRS coordinates. See Entering GRID Coordinates, below.
- O/S. This option lets you offset the waypoint by a bearing, distance, altitude, or grid. See the next section.

When complete, press the UFC ENT button.

## Offset Aimpoints

Offset aimpoints (OAPs) are used to mark locations relative to a waypoint. You can designate the waypoint or the offset aimpoint and receive steering and employment cues relative to either.

### *Creating an Offset Aimpoint*

To add an offset aimpoint, first select the HSI / DATA / WYPT page, then press the pushbutton labeled UFC. The UFC waypoint options will appear:



Figure 50. WYPT UFC Options

Press the button next to "O/S". The offset menu will appear:



Figure 51. Waypoint O/S Menu

Press the button next to "RNG":



Figure 52. Offset Aimpoint Range Menu

Press the button next to a unit of measure, then enter the range from the waypoint to the offset aimpoint, and press ENT.

Next, press the button next to "BRG":



Figure 53. Offset Aimpoint Bearing Menu

Select either true or magnetic bearing, and then enter the bearing from the waypoint to the offset aimpoint in degrees. Enter "0" for due north. Press ENT, then press the button next to "ELEV":



Figure 54. Offset Aimpoint Elevation Menu

Select either feet or meters, then enter the elevation difference from the waypoint to the offset aimpoint. For example, if the offset aimpoint is 25 feet lower than the waypoint, enter "-25". Press ENT.

You can also create an offset aimpoint based on an MGRS coordinate by pressing the button labeled "GRID" on the UFC menu. Doing so will display the grid format on the right DDI:

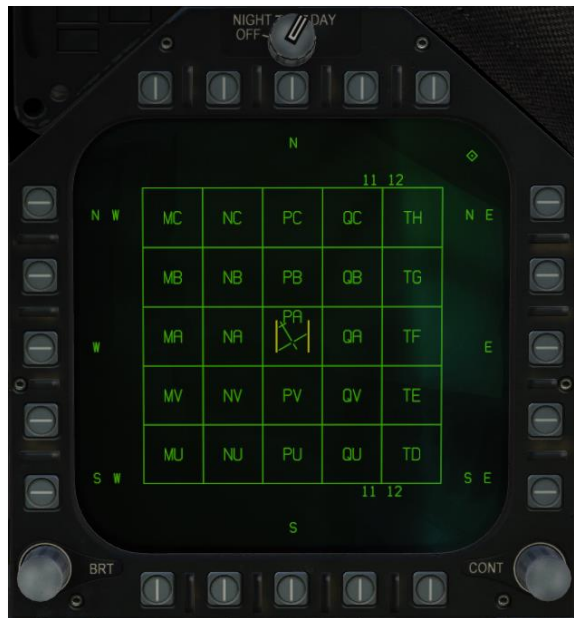

Figure 55. GRID Format

See Entering GRID Coordinates for more information.

Once the offset aimpoint has been configured, the DATA page of the HSI will display the offset aimpoint data:



Figure 56. Offset Aimpoint Data

### Using Offset Aimpoints

When a waypoint with an offset aimpoint is selected on the HSI, both the waypoint and the offset aimpoint are shown, and the text "OAP" appears instead of "WYPT" at PB10:



Figure 57. Offset Aimpoint on HSI

Boxing WPDSG (PB14) designates the waypoint but continues to display the offset aimpoint:



Figure 58. Designated Waypoint with OAP

The label for PB14 changes to "O/S". Pressing this pushbutton designates the offset airpoint:



Figure 59. Waypoint with OAP Designated

## Adding or Deleting a Waypoint

At any time, waypoints can be added or deleted to a waypoint sequence. This is done from the HSI / DATA / WYPT page.

- **To add a waypoint:** Press pushbutton 1, WP SEQUFC, and then the INS Option Select Button on the UFC. Use the keypad to enter the number of the waypoint to add and then press the UFC ENT button. The new waypoint will then be added to the end of the selected waypoint sequence. You can only add the same waypoint to a sequence once.
- **To delete a waypoint:** Press pushbutton 1, WP SEQUFC, and then the DEL Option Select Button on the UFC. Use the keypad to enter the number of the waypoint to delete and then press the UFC ENT button. The new waypoint will then be removed from the selected waypoint sequence.



## Inserting a Waypoint

To rearrange a sequence or add a new waypoint within a sequence, the insert function can be used. This is different than simply adding a waypoint which adds it to the end of a sequence. This can be done from the HSI / DATA / WYPT page.

From the WYPT page, select WP SEQUFC on pushbutton 1. Then, select INS from the UFC Option Select Window.

- Use the UFC keypad to enter the number of the waypoint in which you wish to insert a new waypoint to the right of in the sequence, and then press UFC ENT. You can only add the same waypoint to a sequence once.
- Use the UFC keypad to enter the number of the waypoint you wish to insert to the right of the waypoint you just designed, and then press UFC ENT.

The inserted waypoint will now appear in the active waypoint sequence to the right of the waypoint you designated.

## Entering GRID Coordinates

The F/A-18C can enter waypoint or target coordinates in Military Grid Reference System (MGRS) format. When editing grid coordinates, grid zones are shown on the right DDI, in the Square Identification Grid Format, which is a north-up display of grid squares around your current position.

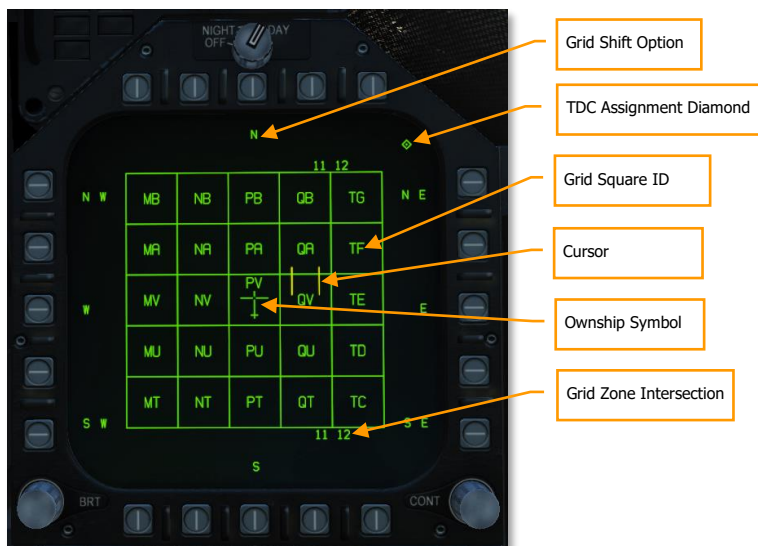

Figure 60. Square Identification Grid Format

**Grid Shift Option.** Slew the TDC over a Grid Shift Option and press the TDC, or press the pushbutton adjacent the Grid Shift Option, to shift the grid by one square in that direction.

**TDC Assignment Diamond.** Shown if the TDC is assigned to this DDI.

**Grid Square ID.** The two-letter designator of a 100×100-km grid square.

**Cursor.** The target designator cursor.

**Ownship Symbol.** Your present location and heading.

**Grid Zone Intersection.** Displayed at the borders between grid zones. Shows the numeric east/west part of a Grid Zone Designation (GZD), such as the "11" in "11S". In the image above, the second vertical line from right marks the border between the 11S grid zone and the 12S grid zone.

To enter a grid coordinate:

1. From the DATA/WYPT page, press the pushbutton labeled UFC (PB20).
2. On the UFC, press the Option Select Button labeled GRID. The Square Identification Grid format shows on the right DDI.
3. Verify that TDC is assigned to the right DDI (the TDC Assignment Diamond is shown).
4. Using the TDC, slew the cursors over the appropriate grid square. You can press the pushbuttons adjacent to each of the cardinal directions to shift in that direction. You can also slew the TDC cursor over a cardinal direction and press the TDC cursor to shift in that direction.
5. Once you have slewed to the grid square, press the TDC. The grid square will be underlined. After a short pause, the MPCD will return to the WYPT display. (The old coordinates, including the old grid square, will still be displayed at this point.)
6. Enter the six-digit easting and northing on the UFC. (If PRECISE is boxed, enter the ten-digit easting/northing.)
7. Press the UFC ENT button. The WYPT page will be updated to reflect the new coordinates.

# TACAN NAVIGATION

The ARN-118 TACAN system provides relative bearing and/or slant range distance to a selected TACAN station (land, ship, or aircraft). TACAN range depends on aircraft altitude Line of Sight (LOS) to the station but can have a maximum range of 200 miles for an airborne station and 390 miles for a surface station. Each TACAN station has a three-letter identifier which is used to identify the beacon and is displayed on the HSI and HUD when using TCN steering.

To use TACAN steering:

1. Select TCN from the UFC
2. Press X or Y of the desired channel from the UFC Option Select Window / Button
3. Turn on the TACAN by pressing the ON/OFF button on the UFC
4. Press CLR (Clear) on the UFC keypad to clear the scratchpad
5. Using the UFC keypad, enter the desired TACAN channel and then press the ENT button on the UFC
6. Select TCN on the HSI display



Figure 61. TACAN UFC Mode

TACAN modes from the UFC include:

- **T/R** (Transmit / Receive). Computes bearing, and measures slant range from the selected TACAN station.
- **RCV** (Receive Only). Only bearing information from the selected TACAN station is computed.
- **A/A** (Air-to-Air TACAN). Computes range for up to five airborne TACAN stations.

- **X.** Selects the X band option.
- **Y.** Selects the Y band option.

With TACAN steering selected with a valid TACAN station channel, steering to the selected station is provided on both the HSI and HUD as follows:

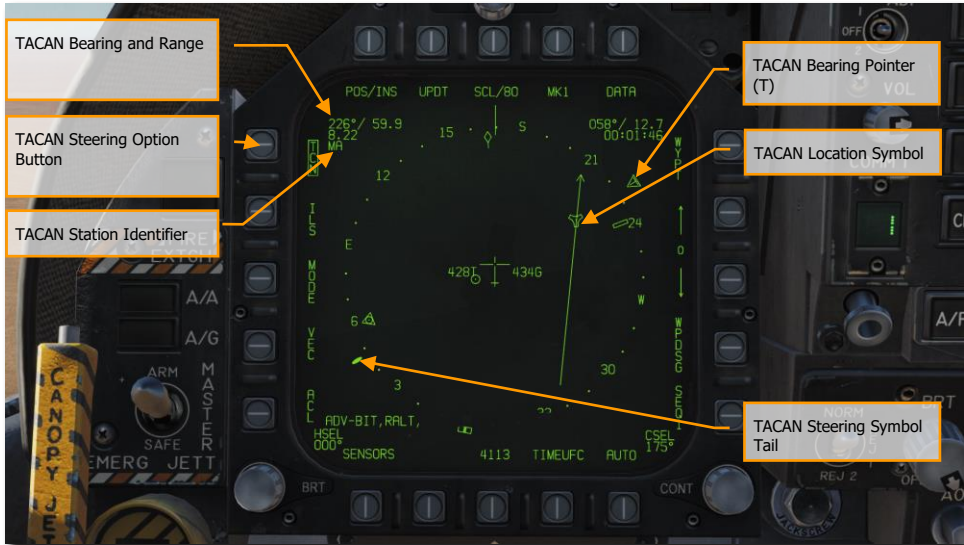

Figure 62. TACAN Steering on HSI



Figure 63. TACAN Steering on HUD

## TACAN Yardstick

A very useful function of the air-to-air TACAN to find and keep formation with other aircraft is what's termed "yardstick". Although the datalink combined with the SA page largely eliminates the need for this, yardstick can still prove useful if the datalink is inoperative.

It is important to remember that TACAN yardstick will only provide range information between you and the other aircraft.

To enable TACAN yardstick:

1. Set TACAN to A/A mode on UFC
2. Set a TACAN channel 63 channels higher than the TACAN channel of the other aircraft, or have the other aircraft set their TACAN 63 channels above yours. One aircraft should be between 1 and 63 X or Y and the other(s) 63 channels higher from that. Note: be careful to avoid TACAN channels already in use by airfields and aircraft carriers and channels 68 and 69 due to datalink conflict.

Once set up, enable TCN navigation on the HSI and note that the heading needle will spin, due to the lack of bearing information. However, you will now have a distance indication. By altering your heading and noting the range increase or decrease, you can often determine the general heading of the other aircraft.

Also note that TACAN yardstick can work between any aircraft with A/A TACAN, it does not need to be only between F/A-18C's.

# DATA OPTION SUBLEVEL

Upon selecting the DATA option button from the top of the HSI page, the DATA sublevel page is displayed with further sublevels for A/C (aircraft), WYPT (waypoint), and TCN (TACAN). The HSI pushbutton returns the MPCD/DDI to the main HSI page.

## A/C (Aircraft) Sublevel



Figure 64. Aircraft HSI DATA Sublevel

The center of the display shows aircraft latitude and longitude, wind speed and direction, and magnetic variation. Below that the horizontal and vertical GPS error is displayed, as well as the current GPS clock time.

**Bank Limit.** Sets the maximum bank that the autopilot will command in CPL (coupled) mode. Cycles between NAV (maximum 30° bank) and TAC (maximum 60° bank).

**GPS Security.** When unboxed, the GPS receiver will use encrypted GPS signals only. When boxed, both encrypted and unencrypted GPS signals are used. Unencrypted GPS is susceptible to spoofing. (N/I)

**Warning Altitudes.** Displays the barometric or radar warning altitude. When passing through this altitude, an aural "ALTITUDE" alert will sound. Pressing the adjacent pushbutton allows you to edit the warning altitude on the UFC. The barometric altitude can be set up to 25,000 feet and the radar altitude up to 5,000 feet. Setting either altitude to zero disables the alert for that setting.

**Heading Mode.** Cycles between magnetic north and true north. This setting affects the display of headings on the HSI, the HUD, the radar, and many other formats. When true north is selected, a "T" or "TRUE" appears next

to any heading shown on most displays. True north is used in the northern or southern areas of magnetic unreliability (AMU) near the north and south magnetic poles.

When using TACAN navigation in true heading mode, the onboard TACAN database is used to lookup a station's magnetic variation. If the TACAN station is not in the TACAN database, TACAN courses will reference magnetic north regardless of the selected heading mode.

Magnetic heading is sensed by the aircraft; true heading is derived from magnetic heading using a magnetic variation database. If the INS fails and the aircraft's position is not reliably known, true heading is not available.

**LAT / LONG Option.** Toggles between degrees-minutes-decimal display (DCML) and degrees-minutes-seconds display (SEC) of latitude and longitude. If PRECISE is boxed under the WYPT page, additional decimal values will be added.

## WYPT (Waypoint) Sublevel

The following items are functional in this early access version:

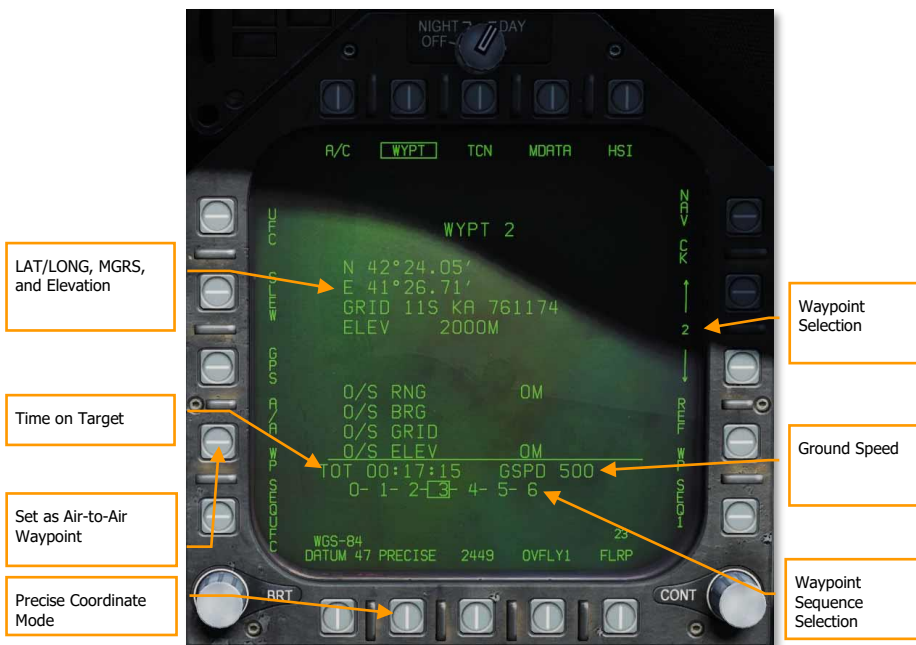

Figure 65. Waypoint HSI DATA Sublevel

**Waypoint, LAT/LONG, MGRS, and Elevation.** At the top of this data block, the selected waypoint is displayed. Below is listed the waypoint:

- Latitude and longitude
- MGRS coordinate termed GRID
- Elevation in meters

**PRECISE Option.** Latitude and Longitude is entered as Degrees/Minutes/Hundredths (LATLN DCML), or Degrees/Minutes/Seconds (LATLN SEC). With PRECISE unboxed, LAT / LONG is entered either as Degrees/Minutes/Hundredths (LATLN DCML) or Degrees/Minutes/Seconds (LATLN SEC). With PRECISE boxed, LAT / LONG is entered either as Degrees/Minutes/Ten Thousandths (LATLN DCML) or Degrees/Minutes/Seconds/Hundredths (LATLN SEC). Actuating the LATLN XXXX option toggles between the selection of LATLN DCML and LATLN SEC. The selected LATLN format is reflected on all displays and UFC formats throughout the cockpit.

**Air-to-Air Waypoint.** Pressing pushbutton 2 sets the selected waypoint as the air-to-air waypoint (aka Bullseye). See Air-to-Air Waypoint section.

**Waypoint Selection.** Pressing pushbutton 12 increments the waypoint and pressing pushbutton 13 decrements the selected waypoint. The current waypoint is displayed between pushbuttons 12 and 13 and at the top of the waypoint data block.

**Ground Speed.** Entered ground speed for last leg to the waypoint set as the TGT.

**Waypoint Sequence Selection.** A listing of the waypoints in the selected sequence (1, 2, or 3). The selected target (TGT) waypoint is boxed.

**Time on Target.** The inputted time on target in reference to Zulu time.

## TCN (TACAN) Sublevel

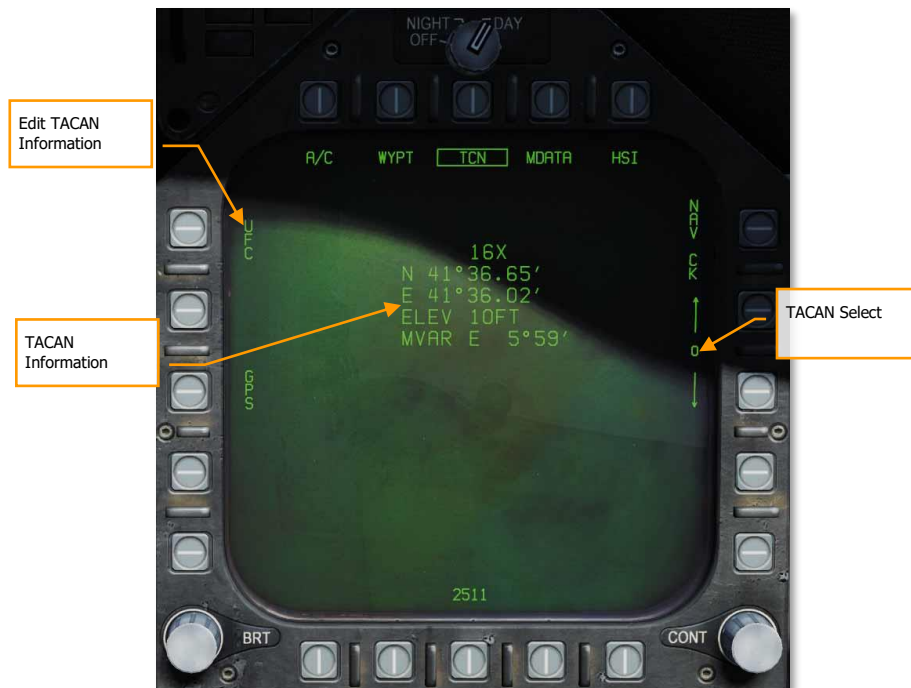

Figure 66. TACAN HSI DATA Sublevel



The TCN sublevel allows you to view and edit TACAN stations in the aircraft's onboard TACAN database. The TACAN database stores the location, elevation, and magnetic variation of nearby TACAN stations. While the aircraft can navigate to any TACAN station, whether or not it is in the TACAN database, having the TACAN station in the database enhances the aircraft's ability to use TACAN as a position source or display the TACAN on the moving map.

Up to ten TACAN stations can be stored in the onboard database. In DCS, the database is pre-loaded with the TACANs in the current theater.

**TACAN Select.** Selects from one of up to ten TACAN stations in the database. Unused database slots are initialized to "1X" with zeroized position, elevation, and magnetic variation.

**TACAN Information.** Displays the position, elevation, and magnetic variation for a TACAN in the database.

**Edit TACAN Information.** Pressing PB5 allows the pilot to edit the selected TACAN station (or to add a new one if an empty slot is selected). Editing options are displayed on the UFC:



Figure 67. Edit TACAN Information

**TACAN Channel.** Displays the TACAN channel. To change the TACAN channel for this database entry, use the keypad to enter the new channel number and press ENT.

**TACAN Band.** Select the option select button adjacent either "X" or "Y" to change the TACAN band.

**Edit Position.** Select this option select button to edit the latitude and longitude of the TACAN station. First enter the latitude using the keypad, then press ENT, then enter the longitude, then press ENT again.

**Edit Elevation.** Select this option select button to edit the elevation of the TACAN station. First select either FEET or MTRS (meters) to colonize the proper units, then use the keypad to enter the new elevation and press ENT.

**Edit Magnetic Variation.** Select this option to change the TACAN station's magnetic variation. Use the keypad to enter the new magnetic variation and press ENT.

# AUTOMATIC DIRECTION FINDER (ADF) NAVIGATION

A third method of navigation is Automatic Direction Finder (ADF). ADF uses radionavigation based on beacons in the 108.0 to 400.0 MHz range. Either radio in the F/A-18C can be tuned to the desired ADF channel and receiving steering information for the selected beacon. However, no range information is given. The bearing to the selected ADF beacon is displayed as a circle on the outer periphery of the HSI compass rose.

## *How to Navigate Using ADF Beacons*

1. Select either 1 (COMM 1) or 2 (COMM 2) from the ADF switch on the UFC
2. Rotate the channel selector of the selected ADF switch to the Manual (M)
3. Using the UFC keypad, enter the frequency of the desired ADF beacon into the UFC Scratchpad and press ENT on the UFC
4. The selected ADF beacon should now appear on the HSI as a circle and the ADF code will be heard (adjusted through the Volume Panel)

Note that this ADF cannot be used with most non-directional beacons (NDBs), which transmit on frequencies between 190 and 1750 kHz. It can be used to navigate to VHF omnidirectional range (VOR) stations, as those typically transmit on frequencies between 108 and 118 MHz.

## ADDITIONAL HSI SYMBOLOGY

In addition to the HSI symbols described above, other symbols are present to assist in navigation. These include:

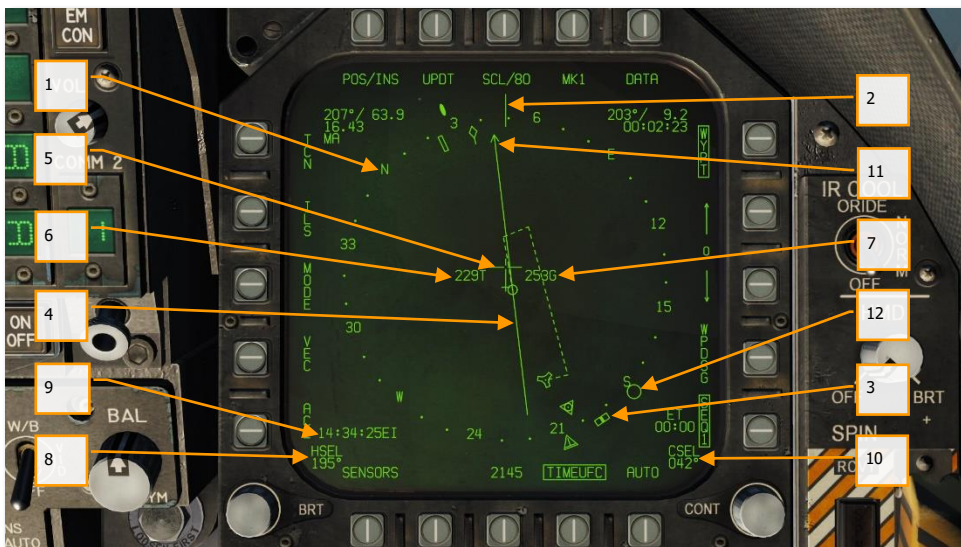

Figure 68. Additional HSI Symbols

1. **Compass Rose.** 360° compass with cardinal directions. The compass rose is referenced to aircraft track by default, to magnetic north when "N UP" is selected under the MODE submenu, or to true north when "N UP" is selected under the MODE submenu, and TRUE heading is selected under the DATA → AIRCRAFT submenu.
2. **Lubber Line.** A line marked on the compass rose that indicates aircraft heading.
3. **Heading Select Marker.** Heading marker on the compass rose to indicate set heading value as indicated in the Heading Select numeric indication.
4. **Course Line.** Set course line through the selected TACAN station or Waypoint and rotated to match the Selected Course numeric.
5. **Aircraft Symbol.** Placed in the center or de-centered in the compass rose, this indicates the location of the aircraft.
6. **Ownship True Airspeed.** True airspeed of your aircraft.
7. **Ownship Ground Speed.** True ground speed of your aircraft.
8. **Selected Heading.** Heading value set using the Heading Select Switch on the MPCD.
9. **Time.** Time indication as selected from the TIMEUFC option button.

10. **Selected Course.** Course value set using the Course Select Switch on the MPCD.
11. **Ground Track Pointer.** Actual track of the aircraft over ground.
12. **Automatic Direction Finding (ADF Symbol).** When ADF is selected to a valid frequency, this icon provides a heading cue to the selected ADF beacon. Not pictured.

## Setting a Course

In addition to the HSI symbols described A course can be set using the Course Select Switch on the MPCD. The selected course value is then displayed on the HSI in the Course Select (CSEL) field and drawn through the selected TACAN or Waypoint. The Course Line has an arrow at the end that points in the direction of the set course. Pressing the Course Switch left and right allows the CSEL to be rotated to match the desired course.

On the HUD, the selected course is displayed as a small arrow with two dots on either side to denote course offset. The arrow provides a horizontal situation indication relative to the Velocity Vector. The dots left and right of the arrow indicate 4° and 8° off course. The dots disappear when course error is less than 1.25°.

Note that the distance to the course line is displayed the CSEL indication. This is particularly useful when flying the correct downwind distance to the airfield or aircraft carrier of 1.1 to 1.3 nm.



Figure 69. Course Setting on HSI and HUD

# AUTOPILOT RELIEF MODES

The F/A-18C includes several autopilots modes that assist the pilot in flying the aircraft. The autopilot modes are displayed by pressing the A/P button on the lower portion of the UFC. The available autopilots modes are listed in the UFC Option Select Windows. Pressing an Option Select Button activates an autopilot mode. The modes include:



Figure 70. UFC Autopilot Modes

- **Attitude Hold (ATTH).** The aircraft will maintain the existing pitch and roll attitude between  $\pm 45^\circ$  in pitch and  $\pm 70^\circ$  in roll.
- **Heading Select (HSEL).** When enabled, the aircraft will turn to and fly the heading as set on the HSI.
- **Barometric Altitude Hold (BALT).** When engaged, the aircraft will maintain the current heading and barometric altitude between 0 and 70,000 feet.
- **Radar Altitude Hold (RALT).** When engaged, the aircraft will maintain current heading and radar altitude between 0 and 5,000 feet.
- **Coupled Hold (CPL).** This mode is available when TACAN or WYPT is the active navigation mode. When engaged, the aircraft will fly to the selected waypoint or TACAN station. The autopilot can also fly specific courses to a waypoint or station, or automatically fly to waypoints in a sequence.

Autopilot modes listed on the UFC are selected by pressing the Option Select Button next to the Option Select Window of the autopilot mode. When selected, a colon is displayed next to the autopilot name on the Option Select Window. Once selected, pressing the ON/OFF button on the UFC enables the mode. An A/P advisory is displayed on the left DDI when an autopilot mode is engaged.

Autopilot is disengaged by pressing the Paddle Switch on the Control Stick.

## Using Coupled Autopilot Mode

When in Coupled mode, the autopilot can fly to a waypoint or a TACAN station, can fly a specific course to a waypoint or TACAN station, and can automatically fly along a sequence of waypoints.

Coupled mode only controls roll, not pitch. You can either control pitch yourself, or activate one of the pitch modes (BARO or RALT) together with CPL.



Figure 71. Coupled Autopilot Controls on HSI

The active sub-mode of coupled mode is displayed on either side of the ownship symbol on the HSI, and on the right side of the HUD. "CPL TCN" is displayed when coupled to a TACAN, "CPL WYPT" when coupled to a waypoint, "CPL SEQ1" when coupled to waypoint sequence SEQ1 with AUTO boxed, and "CPL OAP" when coupled to an offset aimpoint.

If the autopilot has de-coupled because of something other than pilot-commanded disconnect (e.g., loss of TACAN signal), the HUD indicator will flash repeatedly. The flashing will continue until the paddle switch is depressed.

When coupled mode is active, moving the stick will temporarily override it.



Figure 72. Coupled Autopilot Controls on HSI A/C Page

**Bank Limiter.** Cycles the bank limiter between NAV and TAC modes. In NAV mode, autopilot commanded bank is limited to 30° when coupled. In TAC mode, the limit is 60°.

### *Flying Directly to a Waypoint or TACAN Station*

To fly directly to a waypoint or a TACAN station (including a carrier TACAN):

1. Select the waypoint using the HSI format or tune the TACAN station using the UFC. (Verify that the TACAN is on.)
2. Activate the appropriate navigation mode. For waypoint navigation, box WYPT (PB 11). For TACAN navigation, box TCN (PB 5).
3. Press the AP button on the UFC to show the autopilot options.
4. Press the OSB adjacent "CPL" to activate coupled autopilot mode. A colon will appear (":CPL") to indicate that it is active.

Upon crossing the waypoint or TACAN station, the autopilot will transition to heading hold mode and continue flying the current heading.



Figure 73. Coupled Autopilot Controls on HSI WYPT Page

**Overfly Option.** This PB is labeled OVFLY $X$  (where  $X$  is the current waypoint). When boxed, turn anticipation is inhibited. The aircraft will directly overfly the next steerpoint, and turn to intercept the outbound course only after crossing it. When boxed, the OVFLY option applies to all waypoints until unboxed.

### *Flying a Course To/From a Waypoint or TACAN Station*

To fly a course to or from a waypoint or TACAN, follow the steps above, while also selecting a course using the CSEL switch or the UFC. The aircraft will turn to intercept the course (if not already established), and then turn to fly the course once established. The course will be flown either inbound or outbound depending on the selected course direction. (Use the HSI to help visualize which direction the aircraft will fly after intercepting the course.)

After crossing the waypoint or station, the autopilot will continue following the same course outbound.

### *Flying Along a Sequence of Waypoints*

When the autopilot is in coupled in WYPT mode, and the AUTO sequence option (PB 16) is boxed, the navigation system will automatically activate the next waypoint in the sequence upon crossing each waypoint. Use PB 15 to ensure the proper sequence is selected, and press PB 16 to box the AUTO option. When the autopilot is coupled in WYPT mode, the aircraft will automatically fly to each waypoint in the sequence.



# INSTRUMENT CARRIER LANDING SYSTEM (ICLS)

## Mission Practice: Case III Carrier Landing

While real US Navy and Marine Corps F/A-18C's are not equipped with Instrument Landing System (ILS) for airfield landings, they are equipped with the Instrument Carrier Landing System (ICLS). This operates much like a traditional ILS system, but it is only operational for US aircraft carriers.

Using the ICLS is a matter of setting up the correct aircraft carrier ICLS channel and following the localizer and glideslope beams to within visual distance of the IFLOLS.

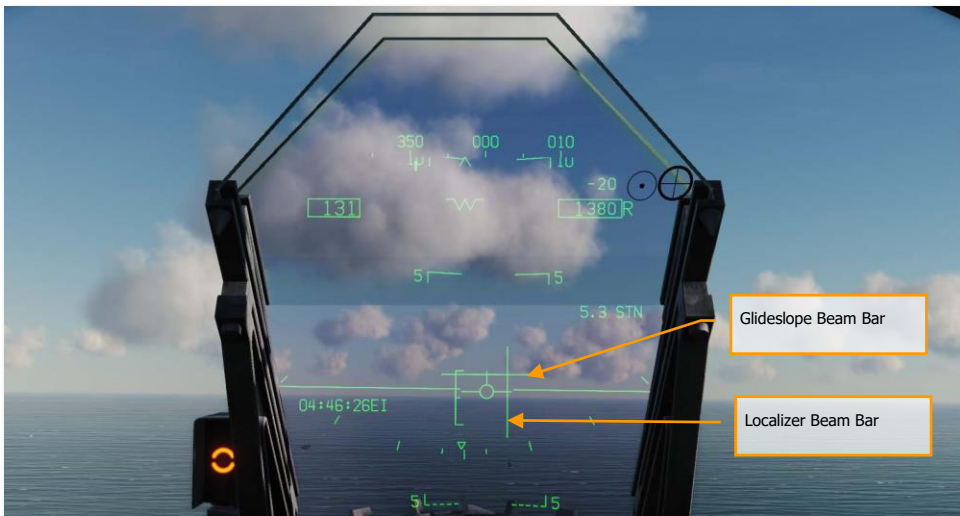

Figure 74. ICLS UFC

Please use the following checklist for a successful ICLS approach.

### *How to Use ICLS*

1. Select ILS from the Up-Front Control (UFC) panel. The carrier ICLS channel will most often be listed in the mission briefing
2. Press the ON/OFF UFC button on the UFC to turn on the ICLS
3. Enter the desired carrier ICLS channel into the UFC scratchpad using the UFC keypad and then press the ENT button
4. Select ILS on pushbutton 5 from the HSI. This will allow ICLS information to be displayed on the HUD and DDI HUD repeater page
5. Fly to keep the vertical localizer and horizontal glideslope bars centered in the HUD. If the localizer is off-center, fly in the direction of the bar to center it. If the glideslope bar is above the velocity vector, you are too low. If it is below the velocity vector, you are too high.



*Figure 75. ICLS HUD Indications*

In the above example image, the pilot is left of the localizer (lineup) and below glideslope. Fly to keep the two bars forming a cross in the center of the velocity vector.

# RADIO COMMUNICATIONS



# VOICE COMMUNICATIONS

## Instant Action Mission Practice: F/A-18C Ready on the Ramp

The DCS: F/A-18C is equipped with two ARC-210 (RT-1556) radios. These act as COMM 1 and COMM 2 and operate as both VHF and UHF radios for air-to-air and air-to-ground voice communications, in addition to Automatic Direction Finding (ADF).

Up to two 20 channels in the 30 to 400 MHz band can be set as pre-assigned frequencies for each radio. Guard frequency operates at 243.00 AM. Preset frequencies are set in the Mission Editor but can be manually edited while in flight.

To radio transmit on COMM 1 or COMM 2, the radio switch on the throttles must be pressed to the selected radio (1 or 2).

### *How to Use the Radios*

1. Select desired radio preset frequency by rotating either the COMM 1 or COMM 2 knob. The frequency preset will be displayed on the Scratchpad.
2. Press COMM 1 or COMM 2 on the radio switch on the throttles based on radio the frequency is tuned to.
3. Use the Radio Menu to issue your radio message.

## UFC Radio Functions

Primary control of the radios is done with the Upfront Control (UFC) include:

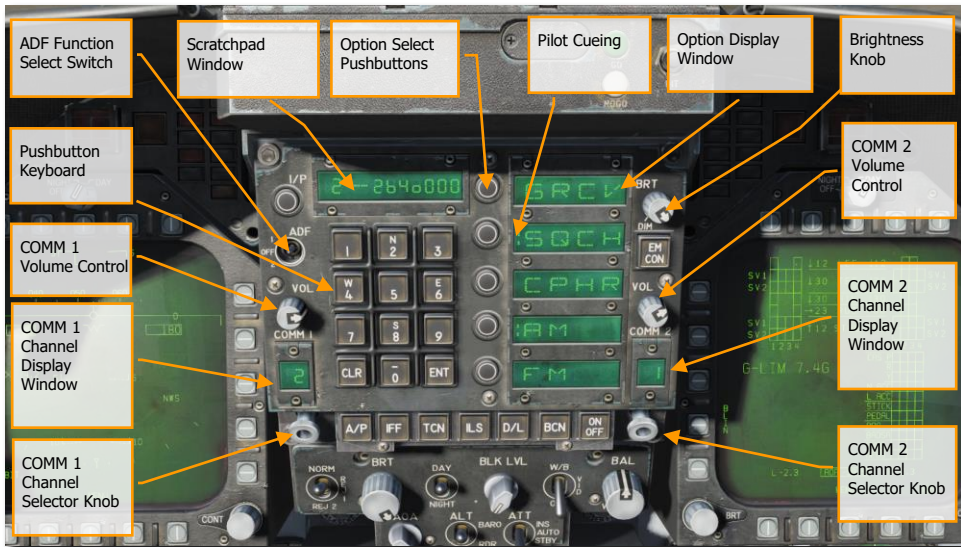

Figure 76. UFC Radio Functions

**COMM 1 and COMM 2 Volume Control.** Rotate these two knobs to control radio volume of the two radios.

**COMM 1 and COMM 2 Channel Selector Knobs.** When either knob is pulled, the active frequency is displayed on the Scratchpad Window. When rotated, they cycle through each of their 20 preset channels. Additionally, manual frequency selection mode (M), guard channel (G) at 121.5 MHz for VHF and 243.0 for UHF, cue channel (C), and maritime (S) are available.

- **1–20.** The radio is tuned to one of the 20 preset frequencies.
- **M.** The radio is tuned to a manual frequency. You can enter a frequency using the UFC keypad without having to override an existing preset.
- **G.** The radio is tuned to the guard frequency, which is an emergency frequency monitored by all aircraft. Guard is 121.5 MHz VHF or 243.0 MHz UHF. The radio will select either the VHF or UHF guard frequency depending on whether the previously tuned frequency was in the UHF or VHF band.
- **C.** The radio tunes to a SINGCARS cue frequency. (N/I)
- **S.** The radio tunes to a maritime channel. Maritime radio channels are numbered from 1 to 28 or 60 to 88. They are used by shipboard radios or coastal stations. Use the UFC keypad to enter the maritime radio channel.

**COMM 1 and COMM 2 Channel Display Windows.** These two windows display the selected preset channel (1-20) and the G, M, C and S selections.

**ADF Function Switch.** This switch enables ADF steering on a selected radio beacon. When ADF 1 is selected, ADF steering is based on the COMM 1 radio setting. When set to ADF 2, ADF steering is regarding the COMM 2 frequency. The OFF setting disables ADF steering.

ADF steering is indicated on the Horizontal Situation Indicator (HSI) as a small circle. See Navigation section of this guide.

**Scratchpad Window.** The selected radio preset, or G, M, C, and S frequency are displayed on the Scratchpad, by either pulling either COMM knob or rotating the knob. The Scratchpad is also used to enter a frequency using the Manual entry (M) mode.

**Option Display Windows.** When a preset or G, M, C, S frequency is selected, options are displayed on the Option Display Windows in the center of the UFC. These include:

- **GRCV.** When selected and colon is visible, Guard is enabled. Guard is disabled when the colon is absent.
- **SQCH.** With colon visible, radio squelch is enabled to reduce the level of radio noise. With no colon displayed, squelch is disabled.
- **CPHR.** Cycles between plain voice radio (uncolonized), baseband cipher mode (:CPHR), and diphase cipher mode (:CPDP). (N/I)
- **AM.** Colon indicates that AM modulation is selected.
- **FM.** Colon indicates that FM modulation is selected.
- **MENU.** Displays a menu for sending or receiving Time of Day (TOD). (N/I)

**Option Select Pushbuttons.** These buttons are used to select the options indicated in the Option Display Windows.

**Brightness Control Knob.** Rotating this knob controls the brightness of the UFC display.

# APG-73 FIRE CONTROL RADAR



USMC photo  
by Sgt Maria Noyola

# AIR-TO-AIR RADAR

Perhaps the most important sensor of the F/A-18C is its' AN/APG-73 radar. The AN/APG-73 is an x-band, all-weather, coherent, multimode, multi-waveform search-and-track sensor that uses programmable digital processors to provide great flexibility in air-to-air tasks.

## Basic Air-to-Air Radar Information

The AN/APG-73 is a pulse-Doppler, look-down / shoot-down radar with both Beyond Visual Range (BVR) and close in, Air Combat Maneuvering (ACM) modes of operation.

The air-to-air radar display uses a standard B-scope format in which the ownship (your aircraft) is in the bottom center of the display. As such, all indications on the b-scope are ahead of the ownship. Targets on the scope are displayed in range from the closest being at the bottom and the more distant being toward the top. Contacts left and right of the ownship are represented as being indicated left and right of the center of the display to indicate azimuth.

Important, basic components of the b-scope include:

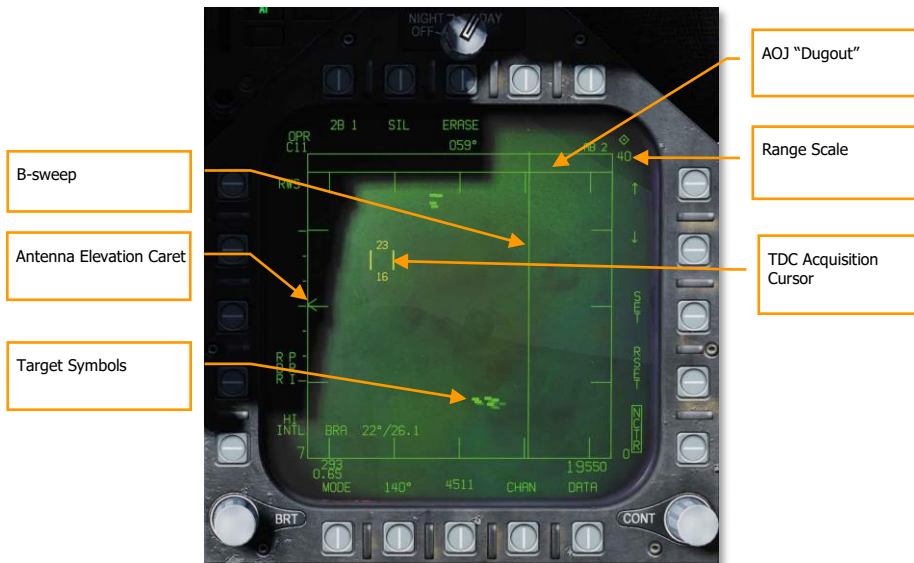

Figure 77. A/A Radar Basic Symbols

**B-sweep.** The B-sweep is a vertical sweep on the display that indicates the instantaneous azimuth position of the radar antenna.

**Antenna Elevation Caret.** The antenna elevation caret symbol indicates antenna elevation in the vertical plane. The symbol is pitch and roll stabilized in reference to the ownship horizontal plane. In search modes, the symbol responds to the radar elevation control on the throttles.



**Range Scale.** The right side of the b-scope represents radar range. The scale includes marks for  $\frac{1}{4}$ ,  $\frac{1}{2}$ , and  $\frac{3}{4}$  of the selected radar range.

**TDC Acquisition Cursor.** Consisting of two parallel, vertical lines, this cursor is moved in response to Throttle Designation Control (TDC) commands on the throttles. When in a radar search mode, the altitude band being covered by the radar beam is indicated above and below the cursor. When placed over a target symbol, the contact's airspeed is indicated to the left of the cursor and its altitude is displayed to the right.

**Target Symbols.** Target symbols are displayed as solid rectangles (bricks). The horizontal position of the target symbol indicates angular position in respect to ownship heading. The vertical position indicates range.

**AOJ "Dugout".** Targets that are denying the radar range information are placed at the top of the b-scope in the Angle on Jam (AOJ) "dugout". Only target azimuth information is available.

**Pushbuttons.** Around the periphery of the radar display are 20 buttons that can be used to control radar modes and parameters. Depressing a button will enable or disable the function, or successive depressions will cycle through all available options for that function.

## A/A Waypoint and Bearing and Range

To gain better situational awareness of the location of other aircraft, both an air-to-air waypoint (A/A Waypoint), also referred to as a bullseye, and bearing and range indicators can be displayed on the A/A radar format. These can be particularly useful in reference to position information from AWACS and other flights and being able to send informative messages to your teammates.

### *A/A Waypoint*

The A/A waypoint must coincide with a waypoint within the waypoint database. It is therefore necessary that the selected air-to-air waypoint is the same position where Bullseye is set for the upcoming mission. Waypoint 59 is automatically entered into DCS F/A-18C at the Bullseye location, however it must be designated as the A/A WP once in the cockpit. To make a waypoint an air-to-air waypoint, use pushbuttons 12 and 13 on the HSI or HIS DATA sub-page to change the current waypoint to the waypoint corresponding with Bullseye. Press pushbutton 2 (A/A WP) on the DATA subpage of the HSI; this will make the waypoint on the bullseye the selected air-to-air waypoint.



Figure 78. HSI/DATA/WYPT

With an A/A Waypoint created, it will then be visible on the A/A radar format as either a circle or diamond with an arrow that points to magnetic north. If the A/A Waypoint and the current waypoint are the same waypoint, the symbol is a diamond. If, however they are different, the symbol is a circle.



Figure 79. Bullseye as Current Waypoint



Figure 80. Bullseye not as Current Waypoint

### Bearing and Range Indications

The A/A Waypoint can now be used as bearing and distance reference:

- A/A Waypoint to TDC. In the top left of the A/A radar format page, the bearing and range from the A/A Waypoint to the current TDC location is displayed.
- A/A Waypoint to Ownship. In the bottom center of the A/A radar format page, the bearing and range from the A/A Waypoint to your location (ownship) is displayed.

Additionally, if BRA is enabled from the RWS / DATA sub-level, bearing and distance from yourself to the TDC can also be displayed in the bottom left corner of the page.

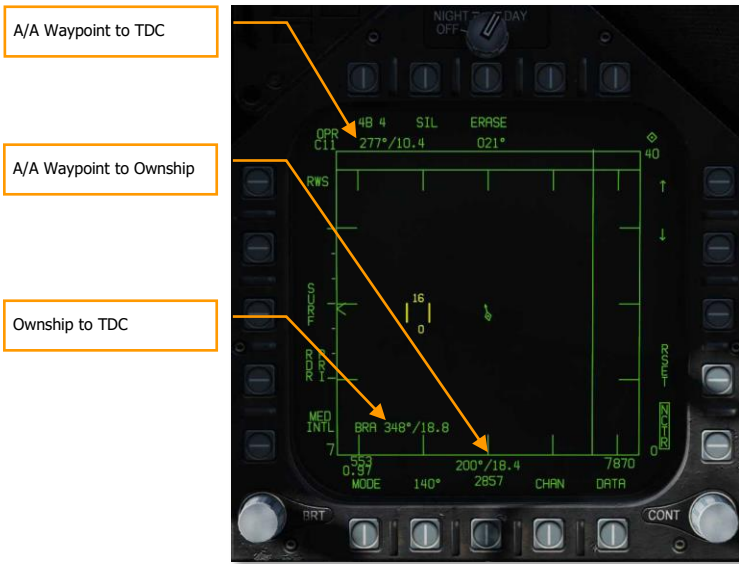

Figure 81. Bullseye and BRA Indications

## Range While Search (RWS) Mode

### Mission Practice: F/A-18C A/A RADAR

Range While Search (RWS) is the default search mode for air-to-air or when an air-to-air missile is placed in priority. RWS mode provides all-aspect (nose-on, tail-on) and all altitude (look-up, look-down) target detection. The display shows range as the vertical axis and azimuth angle on the horizontal.

While in RWS mode, the radar can maintain up to 10 trackfiles.

#### *How to Use RADAR in Beyond Visual Range Mode*

1. RADAR control switch on the Sensor Panel to Operate (OPR)
2. Master Mode switch to A/A or NAV (A/A and A/G unselected)
3. Select Attack RADAR (ATTK RDR) from the TAC page on the right DDI
4. Use Throttle Designator Control (TDC) to move the TDC cursor on the RADAR display tactical area over a radar contact "brick"
5. Lock the target by pressing down on the TDC

Information and functions of RWS mode consist of:

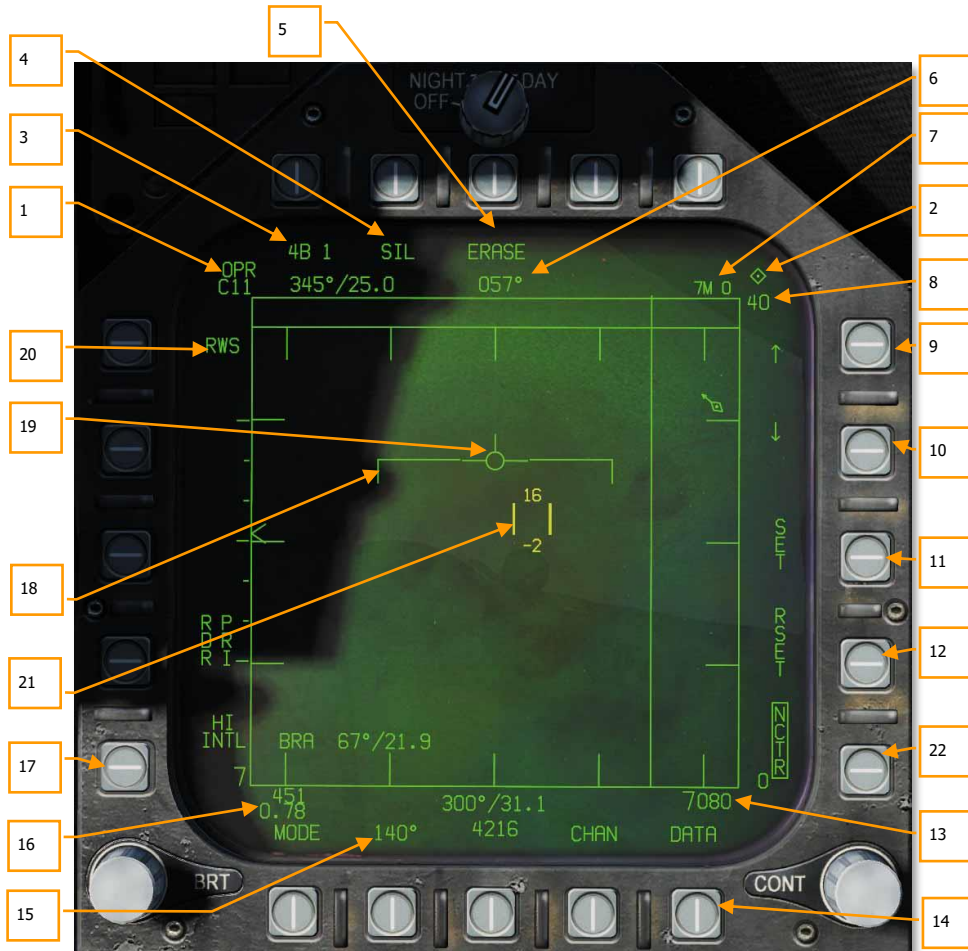

Figure 82. Range While Search (RWS)

Primary control of the air-to-air radar is done with the Throttle Designator Control (TDC). This can be used to position the TDC cursor and pressed to initiate an action.

1. **Operational Mode.** When the radar operating and emitting, this indicator shows OPR. When the radar is in standby mode, it displays as STBY. When the radar is switched off, a crossed-out "RDY" is displayed.
2. **TDC Control Indication.** When the radar display is selected for TDC control, this diamond symbol is displayed in the top right corner of the display. Selecting the radar for TDC control is done by moving the Sensor Control Switch to the right. Note that the radar is normally placed on the right DDI.

3. **Elevation Bar Scan.** When in RWS, successive presses cycle between 1, 2, 4 and 6 bars of raster scanning. The greater the number of bars equates to a larger elevation volume being scanned. However, the greater the number of bars equates to a longer period to complete a complete scan (frame). Bar spacing is generally 1.3°; however, when 5 nm scale is selected, it is 4.2°.  
  
The title of the pushbutton indicates the number of bars and the current bar. In the example image, "4B 1" indicates that the radar is scanning bar 1 of a four-bar scan.
4. **Silent (SIL) Mode.** When SIL mode is selected (boxed), the radar ceases scan operation and places the radar in standby mode. This is also indicated by the Iron Cross shown in the lower left portion of the display.  
  
When in SIL mode, the ACTIVE option is available in the top left corner of the display (replaces target aging indication). When pressed, the radar will conduct one complete scan / frame based on the current radar settings and properties. Once the scan is complete, it will automatically return to SIL mode.
5. **Erase.** By pressing the ERASE push button, all target history on the radar display is removed until detected and displayed again. This also removes all history during Silent (SIL) operation. This can be useful when a long age time is selected.
6. **Heading.** Ownship heading in degrees. This is generally the magnetic heading, but true heading can be selected from the HSI/DATA/A/C sublevel.
7. **Weapon and Number.** The name of the priority weapon and the quantity of the weapon remaining.
8. **Display Range.** Selected display range of the radar. Possible settings are 5, 10, 20, 40, 80 and 160 nm.
9. **Range Increment.** Pressing this pushbutton increases the radar display range. When at maximum range, the increment arrow is no longer displayed. The arrow and function is removed if the radar is in STT mode.
10. **Range Decrement.** Pressing this pushbutton decreases the radar display range. When at minimum range, the increment arrow is no longer displayed. The arrow and function is removed if the radar is in STT mode.
11. **SET.** Pressing the SET pushbutton will save the radar settings for the weapon in priority. This includes display range, elevation bar scan, azimuth, PRF, and target aging.
12. **RESET.** When pressed, the radar settings are returned to the default settings of the weapon in priority.
13. **Altitude.** Ownship altitude.
14. **DATA.** Press this pushbutton to change the radar display to the DATA sublevel.
15. **Azimuth Scan.** The radar can have azimuth scan settings of 20°, 40°, 60°, 80°, and 140°. Pressing this pushbutton cycles between the settings with successive presses.
16. **Airspeed.** Ownship airspeed in IAS and Mach.
17. **PRF.** Pulse Repetition Frequency (PRF) selection between Medium (MED), High (HI), and INTL (Interleaved). Medium PRF minimizes "blind zones" reduces false targets, better all-aspect detection but has less detection range. High PRF has greater range but has inferior low to medium aspect detection. Interleaved alternates Medium and High bar coverage.

18. **Horizon Line.** Mirror of the HUD horizon line.
19. **Velocity Vector.** Mirror of the HUD velocity vector and is displayed at a fixed position and used in conjunction with the moving horizon line to indicate ownship flight path pitch and roll.
20. **Radar Mode.** Indication of the selected radar mode.
21. **Throttle Designator Control (TDC) Cursor.** Two vertical lines with radar elevation volume above and below can be slewed using the TDC when the TDC is assigned to the page.
22. **Non-Cooperative Target Recognition (NCTR).** When under correct parameters, allows the identification of the STT-locked aircraft by type. See the next section.

## Single Target Track (STT) Mode

STT is entered at the completion of manual or automatic target acquisition.

- Pressing the TDC designate button when TDC cursor is over an RWS hit.
- Pressing the TDC designate button twice when the TDC cursor is over an LTWS trackfile.
- Use of AACQ mode or ACM mode.

STT is indicated by the radar attack display. The radar continually monitors the range and angle of the tracked target. This data is used to compute missile or gun attack. The attack display provides intercept course and launch/firing envelope based on computed data. ACM mode and STT launch envelope are not available in navigation aircraft master mode. The AIM-7 requires an STT track for launch unless in HOJ or FLOOD modes.

Automatic Range Scale Adjustment is a function of an STT track. Automatic range scale control is enabled when the radar is operating in STT, or if the RSET pushbutton switch is pressed. If the L&S, DT2, or STT target has a valid range and is within the tactical area, then it is used as a range scale control target. The digital data computer automatically adjusts the range scale so that the furthest range scale control target is displayed at between 40% and 90% of the selected range scale. When the display is expanded about a range resolved L&S target, the digital data computer dynamically adjusts the range scale so that the L&S target range is at the center and the display range limits are that range of 5 nm. Automatic range scale control increments and decrements the range scale in STT, but only increments the range scale in TWS. If the range scale is manually adjusted, then automatic range scale control is disabled until the RSET pushbutton switch is pressed.

It is important to understand that when in STT mode, the radar is only focused on a single contact and will not display other contacts.



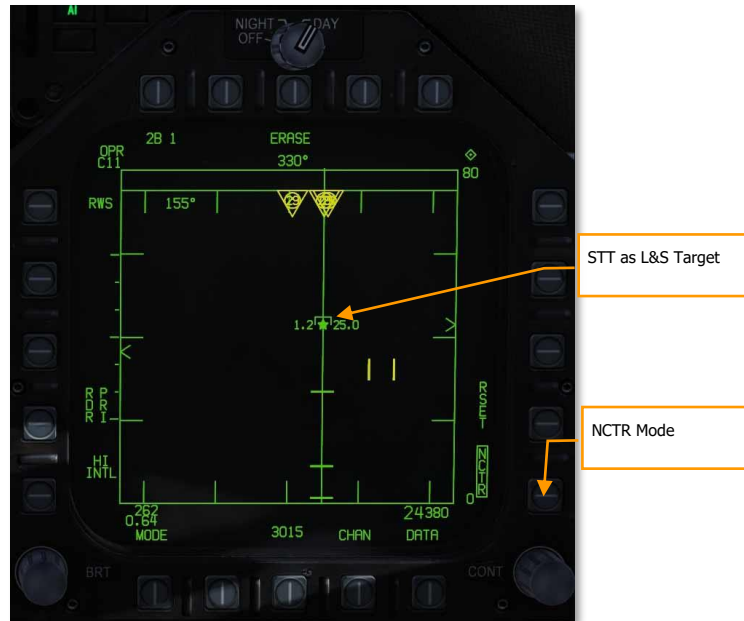

Figure 83. Single Target Track

### Non-Cooperative Target Recognition (NCTR) Mode

When a contact is tracked as the STT L&S target, the NCTR function allows aircraft type identification under certain parameters. The NCTR function can be selected from pushbutton 15 on the RWS format page.

NCTR works on the principle of the engine fan blades having distinct characteristics that can then be correlated to an aircraft type. This can only be achieved with an STT track of the target and:

- Target is within 25 nm.
- Target is within 30° nose-on or tail-on.

The identification results are displayed on the SA page when the TDC cursor is placed over the target. The type will then be displayed in the data block located in the bottom right corner of the page.

NCTR can be an important function for two-factor target identification.

### One-Look RAID

One-look RAID applies RAID processing to returns detected while in single-target track mode. This allows the radar to display targets nearby the L&S as bricks. One-look RAID has the capability to break out targets within about 1.5° of the L&S (one beam width). At 25 NM, one-look RAID can break out a target within 1 NM of the L&S.

To activate One-Look RAID, box it on the DATA page. See Range While Search (RWS) DATA.

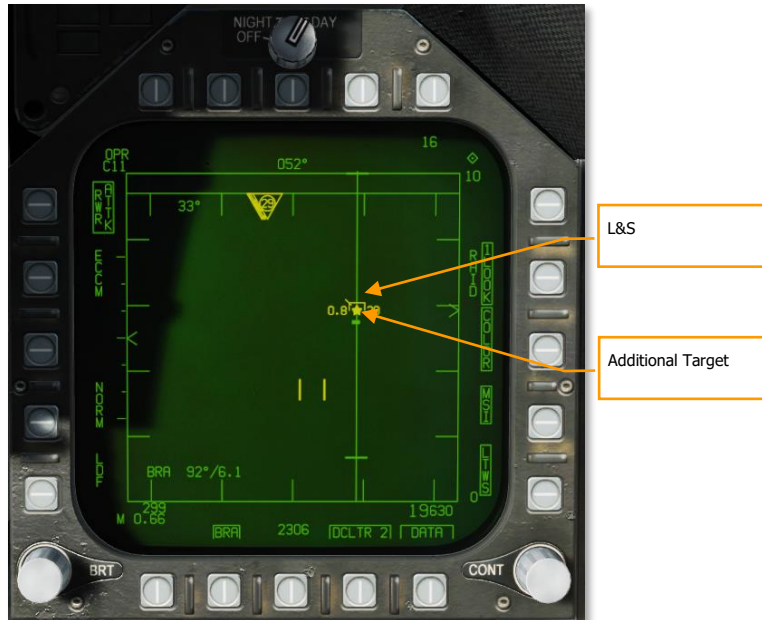

Figure 84. One-Look RAID

When activated, a one-look RAID scan is performed every 1.5 seconds. Any additional targets detected by one-look RAID are displayed as uncorrelated bricks.

## Spotlight (SPOT) Sub-Mode

Spotlight (SPOT) is an air-to-air radar sub-mode that constrains the radar azimuth to a specific area under the TDC. SPOT mode provides a very high update rate and is used to discriminate between closely spaced targets and acquire the desired target within a group.

SPOT sub-mode can be activated from any air-to-air radar mode except STT and STT RAID. To enter SPOT sub-mode, first position the TDC over the area you wish to spotlight, then press and hold the TDC z-axis for more than one second. The radar azimuth indicator will drive to the TDC location and begin a scan centered on the cursor and constrained to 22° of azimuth.



Figure 85. SPOT Sub-Mode

SPOT sub-mode is indicated by the presence of an "X" within the TDC. The scan area can be slewed by moving the TDC left or right. To exit SPOT sub-mode, press and release the TDC. SPOT sub-mode is also exited by pressing the undesignate button or assigning TDC to another display.

SPOT sub-mode can also be used with an AACQ mode. When SPOT sub-mode is activated from an AACQ mode, the radar will attempt to STT the first target detected while SPOT is active.

## Air-to-Air Radar HOTAS Controls

When flying air combat missions, it is very helpful to keep your hands on the stick and throttle and not have to take your hands off them to manipulate controls. The F/A-18 has an excellent set of Hands-on Throttle and Stick (HOTAS) controls. Here are some of the more important HOTAS functions to know for air-to-air combat:

### *Control Stick*

On the control stick, the Sensor Control Switch and the Undesignate Button are vital. When in Beyond Visual Range (BVR) mode, pressing the Sensor Control Switch to the right will set TDC control to the radar when on the right DDI. When the display has the TDC assigned to it, a diamond with a dot in the center is displayed in the top right corner of the display.

Pressing the Sensor Control Switch to the right when the TDC is already assigned to it will place the radar in Auto Acquisition (AACQ) mode. If the TDC is over a target symbol when AACQ is commanded, it will instruct the radar to lock on to that target. If AACQ is pressed with no target symbol under the acquisition symbol, then the radar will attempt to lock on to the closest target within the selected radar scan volume.

**Sensor Control Switch.** There are two general modes for this four-way switch. When in air-to-air mode:

When in Beyond Visual Range (BVR) mode, it functions as:

- Forward: Switch to Air Combat Maneuvering (ACM) mode with Boresight being selected by default
- Aft: Assigned TDC to center, MPCD
- Left: Assigns TDC to left DDI
- Right: TDC to right DDI or enters radar in Auto Acquisition mode if TDC already assigned to the right DDI

When in ACM mode, the Sensor Control Switch works as:

- Forward: Radar Boresight (BST) mode
- Aft: Radar Vertical Acquisition (VACQ) mode
- Left: Radar Wide Angle Acquisition (WACQ) mode

**Weapon Select Switch.** This is a five-position switch that allows you quickly to set the selected air-to-air weapon as priority. In doing so, it will also set the radar to default settings to best employ the weapon:

- Forward: AIM-7 Sparrow
- Press Down: AIM-9 Sidewinder
- Aft: M61A1 20mm Gun
- Right: AIM-120 AMRAAM
- Left: No Function

**Trigger.** Fires forward directed weapons like the gun and air-to-air missiles.

**Undesignate Button.** When in air-to-air mode, the primary function of the Undesignate Button is to un-lock a radar-designated targets. It can also be used to return to radar search mode when in a radar ACM mode.

### *Throttle*

The two most important radar controls are the Throttle Designator Controller (TDC) and the radar elevation control.

The radar elevation control is a wheel that when rotated back elevates the radar scan and when rotated forward lowers the elevation scan.

The TDC is a cursor control with a press-button function. When assigned to the radar on the right DDI, it controls the TDC acquisition cursor within the radar tactical display area. When on the air-to-air radar display, the number above and below the TDC cursor indicate the maximum and minimum altitude coverage of the radar at the range of the TDC on the display.

When the TDC is moved across the display boundary, it can be used for radar mode and parameter changes. If the TDC is moved over the boundary into the mode selection area, the mode options will appear on the display. Positioning the cursor over the desired mode and depressing the TDC will command the radar to display the optimum parameters for the mode selected. Other parameters shown around the perimeter of the display may also be controlled.

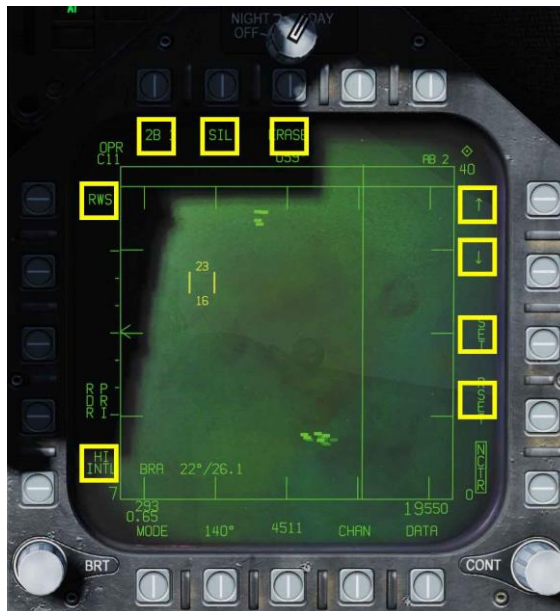

Figure 86. HOTAS TDC Control Zones

## Range While Search (RWS) DATA

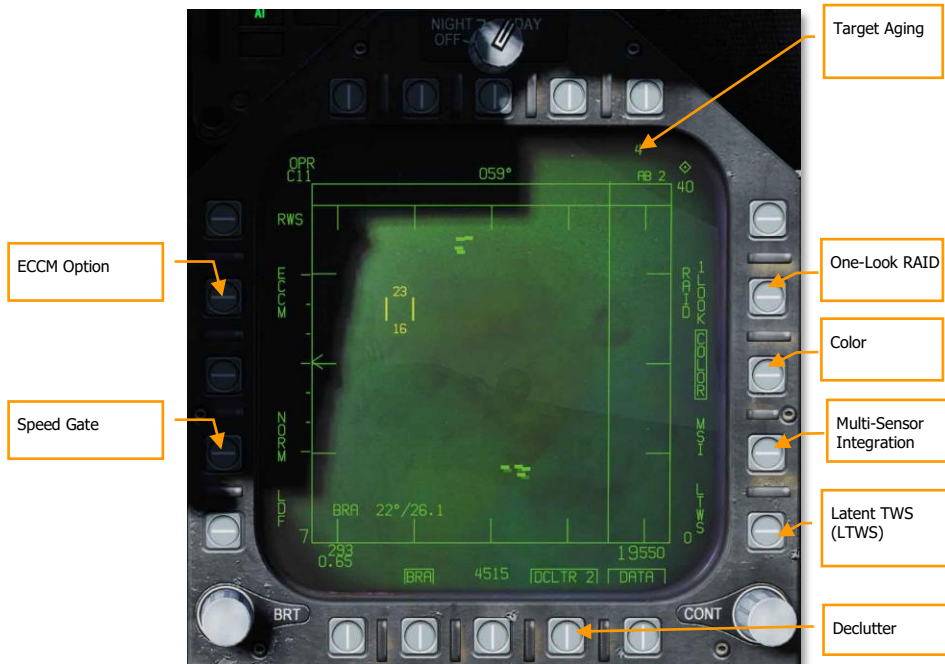

Figure 87. RWS DATA Sublevel

**Target Aging.** The amount of time a target symbol remains on the display after radar contact has been lost can be adjusted with successive presses between 2, 4, 8, 16 and 32 seconds.

When SIL mode is selected, this field is replaced with the ACTIVE indication.

**One-Look RAID.** When boxed, performs one-look RAID analysis in STT mode. See One-Look RAID.

**Color.** Selects the radar display to be presented in monochrome or limited use of colors of three colors. In addition to displaying the TDC cursor in yellow, it also allows trackfiles in LTWS and TWS modes to be displayed in yellow and red.

**Latent Track While Scan (LTWS).** LTWS provides a Track While Scan (TWS) function while in RWS mode. With LTWS enabled, placing the TDC over a target symbol will display Launch and Steer (L&S) track symbols. However, no "Shoot" cues are displayed. An LTWS target will have its' airspeed in Mach displayed to the left and its altitude in thousands of feet to the right. Additionally, its range and closure information are displayed along the right tactical border.

**Multi-Sensor Integration (MSI).** When enabled, allows datalink information to be integrated with LTWS and TWS modes.

For more information on these two options, see Latent Track While Scan (LTWS) Mode in the next section.

**DATA.** Exits the DATA sublevel.

**Declutter.** Allows selection of two levels of declutter from the radar display. DCLTR1 removes the horizon line and velocity vector. DCLTR2 removes all DCLTR1 items, plus target differential altitude, target heading, range rate numeric, and the range caret when in STT mode. The selected mode will be indicated as boxed DCLTR1 OR DCLTR2.

**Speed Gate.** Selects between Normal (NORM) and WIDE target speed gates to determine the width of the doppler radial velocity notch. This is used to not detect/filter out slow moving targets like cars and general aviation aircraft. When in WIDE mode, the notch filter is increased, and slow targets will be detected and displayed. (Coming later in Open Beta)

**ECCM.** Enables or disables Electronic Counter-Counter Measures. When enabled, the jamming effects of hostile aircraft are less pronounced, but the sensitivity of the radar is reduced. (Coming later in Open Beta)

## Air Combat Maneuvering (ACM) Modes

The ACM radar modes are designed for close-in combat with auto acquisition in mind. The ACM modes can be selected by either pressing forward on the Sensor Control Switch while in air-to-air BVR mode, or by pressing aft on the Weapon Select Switch to set A/A GUN as priority.

Except for the Guns Acquisition mode, any air-to-air missile can be used for all ACM modes.

### *How to Use Radar in Air Combat Maneuvering (ACM) Mode*

1. Radar control switch on the Sensor Panel to Operate (OPR)
2. Master Mode switch to A/A
3. Select Attack Radar (ATTK RDR) from the TAC page on the right DDI
4. Press forward on the Sensor Control Switch to enter ACM mode, or...
5. Press aft on the Weapon Select Switch to set A/A Gun as priority and place the radar in Gun Auto Acquisition (GACQ) mode
6. Once in ACM mode, use the Sensor Control Switch to select ACM modes: forward for Boresight (BST), aft for Vertical (VACQ), and left for Wide Angle (WACQ)

There are four ACM modes:

- **Gun Acquisition (GACQ)** mode is automatically enabled when air to air guns is selected. This mode is represented as a 20°, dashed circle on the HUD that encompasses the entire HUD field of view. Unlike the other ACM modes, GACQ can only be used for guns. GACQ searches for targets out to 5 miles.
- **Boresight (BST)** by pressing forward on the Sensor Control Switch. When selected, a dashed, 3.3° circle is displayed on the HUD. This circle indicates the radar's auto-acquisition search zone. BST searches for targets out to 10 miles.
- **Vertical Acquisition (VACQ)** mode is selected by pressing aft on the Sensor Control Switch. Upon doing so, two, dashed vertical line are displayed in the HUD. This vertical auto-acquisition search pattern covers from -13° to +46°. VACQ searches for targets out to 5 miles.
- **Wide Acquisition (WACQ)** is a spaced-stabilized mode and is selected by pressing left on the Sensor Control Switch. Upon doing so, a rectangle is displayed in the lower right corner of the HUD. This rectangle represents the auto acquisition scan pattern and can be slewed using the TDC controller when uncaged. The rectangle is placed on a grid that represents the complete scan limits of the radar. WACQ searches for targets out to 10 miles.

- **Automatic Acquisition Mode (AACQ)** is selected from the BVR radar modes, like RWS. It is not selected from the ACM modes. When in a BVR radar mode and the TDC cursor is not over a target symbol, the radar will attempt to auto lock the nearest target in its search pattern when the Sensor Control switch is moved right. AACQ searches for targets out to range setting of the radar.

### *WACQ Uncaged Mode*

When WACQ is active, the scan area is normally caged to the center 60° of azimuth and 10° of elevation. By depressing the TDC, you can uncage the scan area and slew it with the TDC. When you do, the scan area is displayed on the HUD:

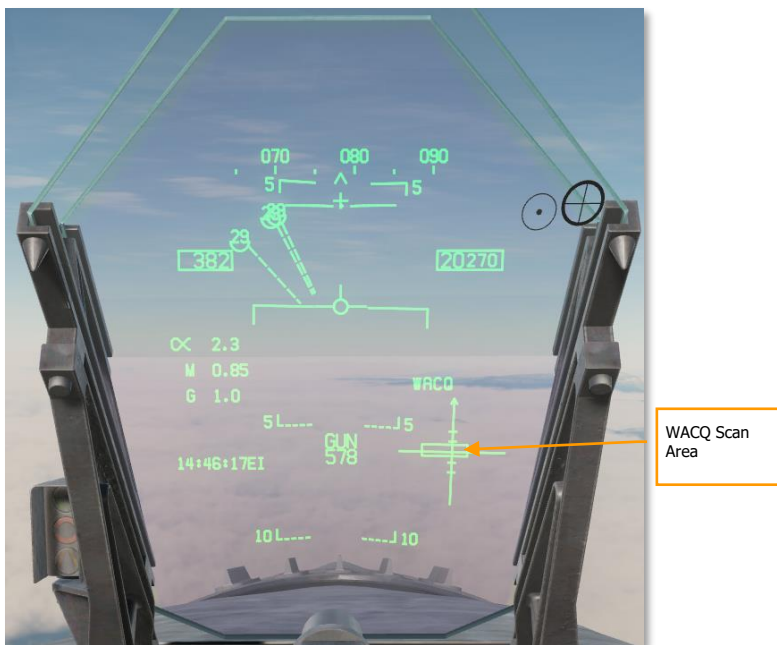

*Figure 88. WACQ HUD symbology*

Moving the TDC left or right shifts the 60° scan azimuth left or right within the 140° scannable cone. Moving the TDC up or down shifts the 10° scan elevation up or down. The first target detected inside of 10 nautical miles will be automatically locked.



## Track While Scan (TWS) Mode for the F/A-18C

### *Overview*

The Track While Scan (TWS) air-to-air acquisition mode of the radar is the ideal choice maintaining radar situational awareness, track and engage multiple targets, have more azimuth control of the beam, and have the tools to break-out targets in close formation.

TWS mode can be selected from pushbutton 5 on the attack radar page. Pressing toggles between RWS and TWS search modes. TWS appears like LTWS and includes L&S, DT2, LARs, etc. The primary difference is the ability to show up to 10 trackfiles, plus raw hits, and more beam control options. The other big difference is that it allows weapon engagement with the AIM-120.

In TWS mode, targets are ranked by threat priority. These are indicated with a HAFU and aspect stem (L&S, DT2, and up to eight more Tracked Targets). If HITS is enabled, up to 64 contacts can be displayed as a maximum. HITS appear as "bricks" on the radar display.

Only targets within the current range display are ranked. However, if a target is ranked and the display scale is changed such that a contact is no longer displayed, it is kept as a primary or secondary trackfile. In such a case, this target would be at the very top or bottom of the display.

The highest priority target is always assigned as the L&S target. An L&S target in TWS can be commanded to STT by designating it. L&S data and symbology is the same as we currently have in LTWS mode. If an TWS L&S target is engaged with an AIM-7, the radar will automatically change to STT mode when launched.

The 2<sup>nd</sup> highest priority trackfile is the DT2 target. This is also displayed the same as we have for LTWS mode.

When in TWS mode, press right on the Sensor Control switch will place the L&S target into STT.

### *Target Designation*

When TWS is first selected, the highest priority tracked target is automatically set as the L&S, but no DT2 is automatically set. To designate any tracked target as a DT2, designate that track using TDC Designate. To set the DT2 track as the L&S track, designate the DT2 track (TDC Designate); this will swap the DT2 and L&S tracks. You can also press the Undesignate button to swap the L&S and DT2. If no DT2 is created, pressing the Undesignate button will cycle the L&S among tracks in priority order.

If there is a DT2, pressing the Undesignate button will swap the priority of the L&S and DT2 targets. In this way, you can quickly set the DT2 target as the L&S target.

Designating a non-tracked target ("hit") will set it as a track. The lowest priority track would then be dropped, displaying as a hit instead.

## TWS Display Format

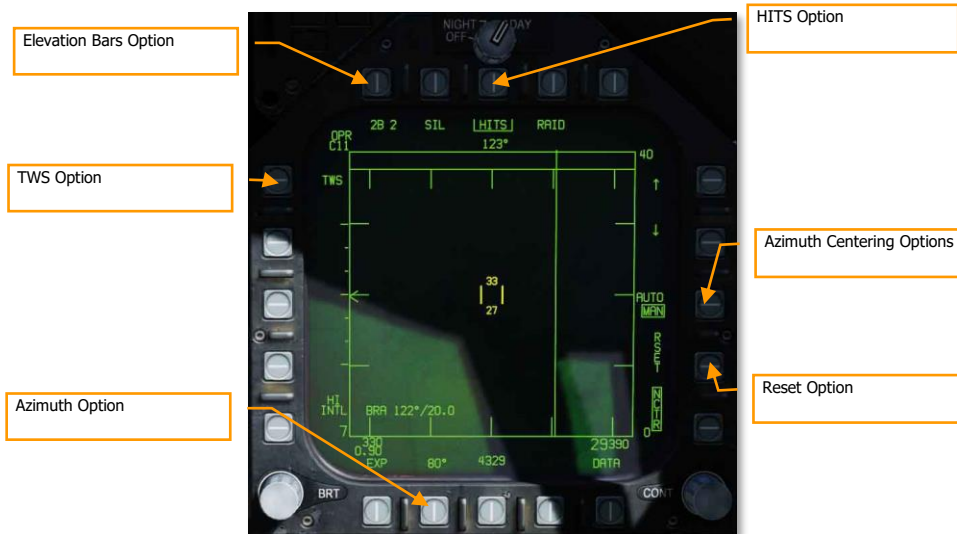

**HITS Option.** When enabled, “raw” hits (bricks) are displayed that are outside the 10 ranked trackfiles. These are essentially RWS contacts that can be displayed in TWS mode. They are also rendered at a lower intensity than the trackfiles.

**TWS Option.** If the radar is in STT mode with AIM-9 or AIM-7 selected, the TWS option is available. If selected, it will exit STT to TWS and make the previous STT target the L&S.

**Azimuth Option / Elevation Bars Option.** When in TWS, there are three bar options with corresponding azimuth options:

- 2 bar = 20°, 40°, 60°, and 80°
- 4 bar = 20° or 40°
- 6 bar = 20°

For 4 and 6 bars, the elevation bar spacing is 1.3-degrees. For 2 bars it is 2°.

**Azimuth Centering Options.** When in TWS mode, the AUTO and MAN options are available on the right side of the display. This allows either manual or automatic scan centering based on which option is selected/boxed.

- **AUTO:** The azimuth and elevation TWS scan is centered on the L&S trackfiles. If TWS is entered from an STT track, AUTO mode is automatically selected.

When in AUTO mode, the player should be able to place their TDC cursor anywhere but on a contact and depress the TDC switch to re-center the scan azimuth on that location. When this is done, AUTO is replaced with BIAS on the display. This sets a new scan centroid. BIAS is removed when RESET is pressed, TWS is exited, RAID is selected, MAN mode is selected, or no trackfile exists.

- **MAN:** The scan center will not change automatically, but rather the azimuth scan center can be moved with the TDC cursor. If the scan is positioned outside the gimbal limits of the radar, the scan

will be repositioned such that the scan will be able to search its entire azimuth. MAN mode is the default.

Trackfiles that move outside of the scan volume area will disappear after a few seconds.

**RESET.** When pressed, all manually added trackfiles are dropped and resumes normal tracking and trackfile prioritization.



**Expand (EXP).** When there is an L&S target in TWS mode and EXP is pressed, the display will change to a 10 nm range centered on the L&S with a 20° azimuth scan. The display range on the right side of the display will indicate the 10 nm scan area (for example: 30 at the top and 20 at the bottom). Despite the 20° azimuth scan, the legend will still indicate the previous setting and the b-sweep line will freeze on the L&S.

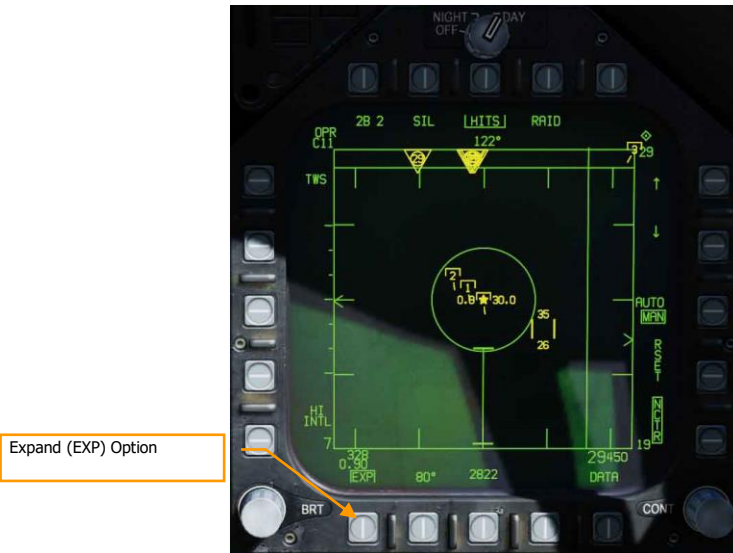

This mode simply zooms in on that area, but the TWS scan operation, target rankings, etc. does not change. Trackfiles that are outside of the display will be clamped to the screen edge.

**SCAN RAID Mode.** This is selected from the SCAN RAID button on the throttle or by pressing PB9 (RAID). It concentrates the TWS scan to a small area to break out closely spaced targets. When enabled, the scan is centered on the L&S target. It is displayed in a standard range and azimuth format in 10 nm zoomed in display at 22° of azimuth, with a 2-bar elevation. The b-sweep line is frozen on the L&S target and SCAN RAID appears at the bottom of the display.

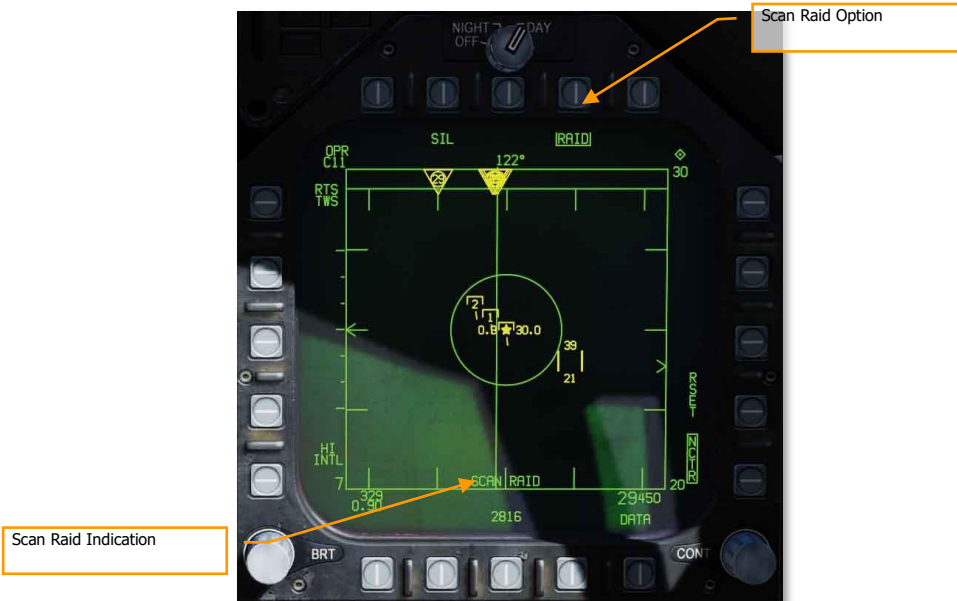

When in this mode, trackfiles and raw hits are displayed. If a new L&S target is designated, the RAID SCAN will move to that location. Trackfiles that are outside the display area will be clamped to the edge of the display.

When selected, AUTO scan centering is automatically selected and cannot be unselected while in this mode.

## Latent Track While Scan (LTWS) Mode

When in RWS mode, the LTWS option is available on the DATA sub-level of the attack radar format. The LTWS option is initially boxed by default, indicating that LTWS is selected. LTWS is only available when the radar is in RWS mode.

When LTWS is disabled (unboxed), no HAFU symbols will be displayed on the radar, only bricks representing radar returns. Boxing LTWS will display HAFU symbols for MSI trackfiles supported by the radar only — in other words, donor HAFUs from other aircraft will not be displayed, only HAFUs that are correlated to radar returns.

When LTWS is boxed, the pilot can designate the HAFU trackfile under the acquisition cursor. Designating a trackfile displays its speed (in Mach) and altitude on either side of the HAFU, just as in TWS mode. If the designated trackfile is one of the eight priority trackfiles, its launch zone will also be displayed.

Designating an LTWS trackfile sets it as the L&S target (indicated by a star inscribed in the HAFU). Once the L&S has been set, designation of a second trackfile will make that trackfile DT2 (indicated by a diamond inscribed in the HAFU). In this manner, two trackfiles can be tracked, and a third can also be tracked by hovering the acquisition cursor over its HAFU symbol.

It is important to note though that **weapons cannot be employed in LTWS mode**. To employ a weapon, the radar must be in STT or TWS mode.

When LTWS is unboxed, HAFU symbols are not displayed, even when the acquisition cursor is hovered over a radar target.

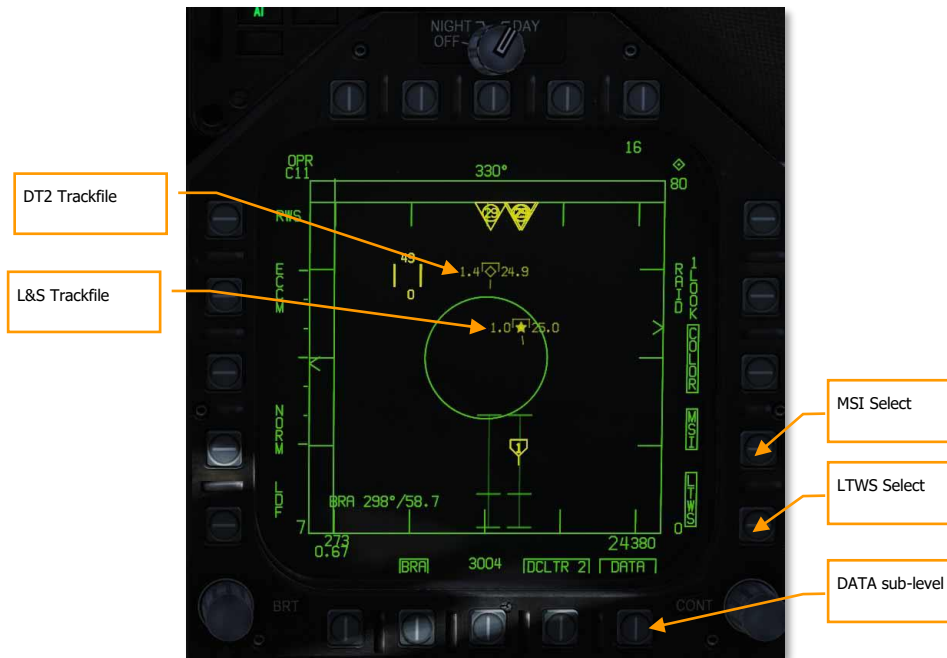

Figure 89. Latent Track While Scan

When both L&S and DT2 are created, they will appear as two separate indicators on the HUD. The L&S appears as a box and the DT2 trackfile appears as an "X".

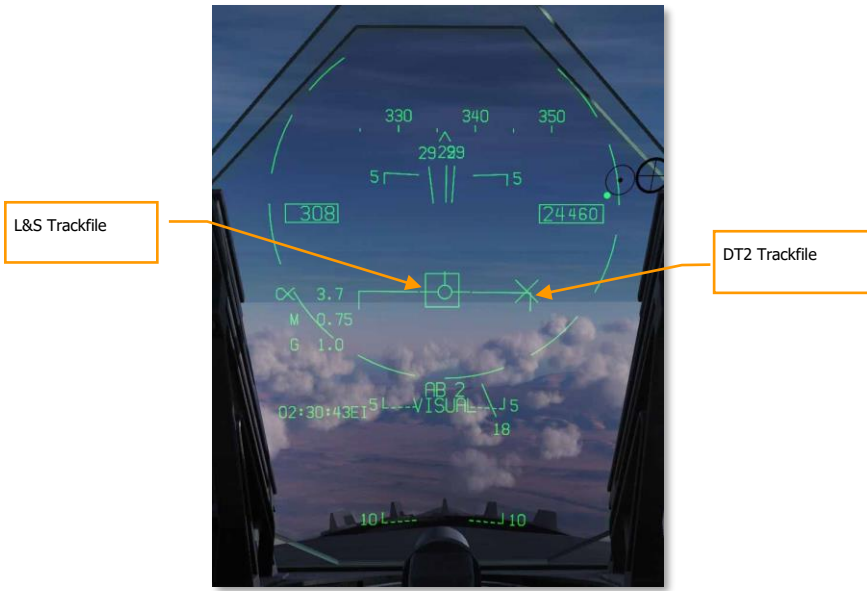

Figure 90. Latent Track While Scan HUD

### Multi-Sensor Integration (MSI)

When LTWS mode is enabled, the pilot can further enable multi-sensor integration (MSI) using PB 14. When MSI is boxed, donor targets are displayed as HAFUs even when the TDC is not over an LTWS trackfile. This makes the radar presentation appear like the SA format, giving the pilot a more complete air-to-air picture

Trackfiles detected solely by onboard sensors (without a contributing donor aircraft) are displayed as standard RWS bricks.

Note that MSI for RWS can only be displayed when the LTWS mode is enabled.

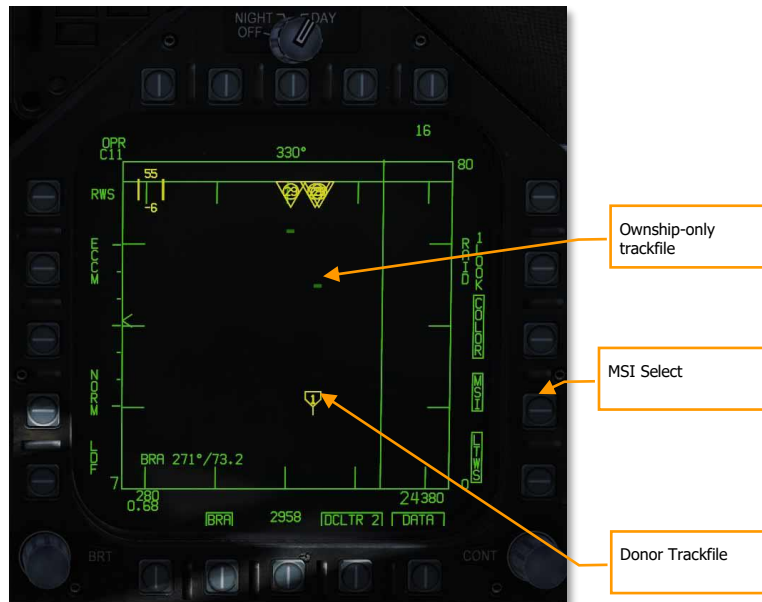

Figure 91. Latent Track Scan with MSI



# AZ/EL FORMAT

The azimuth-over-elevation (AZ/EL) format displays a forward-looking view of targets detected by the radar and other sensors. Unlike the normal Attack Radar format, which is a top-down B-scope display, the AZ/EL format is a boresight display, showing the "view out the nose." The AZ/EL page combines HAFU symbols from the multi-sensor integration (MSI) platform with returns detected by either the radar or the FLIR.

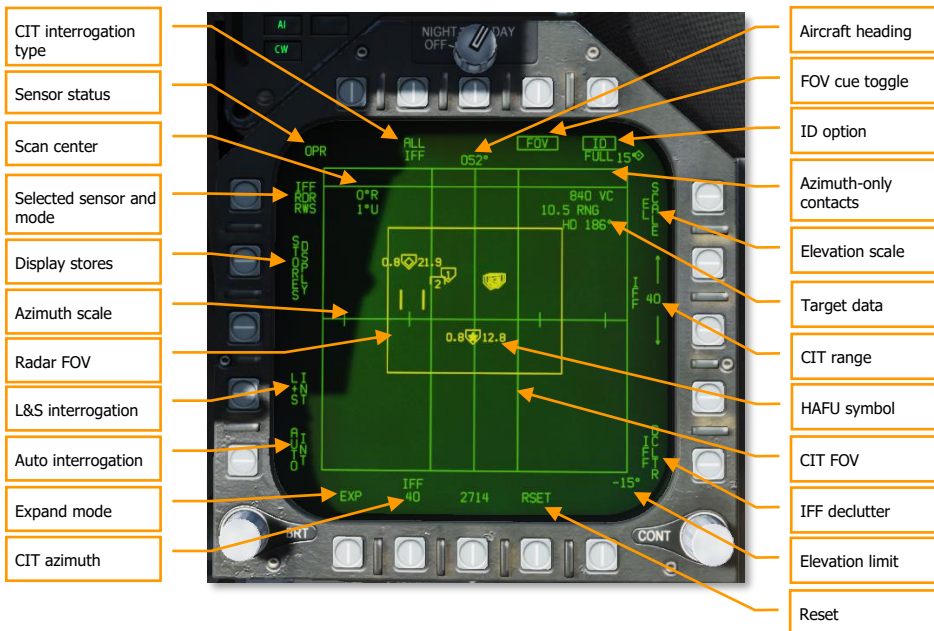

Figure 92. AZ/EL Format

**Selected sensor and mode:** Pressing this pushbutton toggles between the radar and the FLIR as the active sensor. In either case, MSI tracks are displayed along with sensor returns. The sensor mode is shown as either RDR or FLIR, and underneath is the sensor sub-mode (RWS, TWS, or VS for RDR; PNT or TRACK for FLIR).

**Sensor status:** Displays the status of the selected sensor. For RDR: OFF, STBY (standby), OPER (operating), SIL (silent), DEGD (BIT or MUX failure), EMCON (suspended), or TEST (self-test). For FLIR: OFF, STBY, OPER, DEGD, or TEST.

**Elevation scale:** Cycles between scan volumes:  $\pm 70^\circ \times \pm 5^\circ$ ,  $\pm 70^\circ \times \pm 15^\circ$ ,  $\pm 70^\circ \times \pm 30^\circ$ , or  $\pm 70^\circ \times \pm 70^\circ$ .

**Elevation limit:** Shows the positive and negative elevation limits, selectable using PB11 (EL SCALE). The positive limit is shown at the top-right; the negative limit at the bottom-right.

**Radar FOV:** Shows the horizontal and vertical extent of the radar scan volume. This box is dimmed when FLIR is the active sensor.

**FOV cue toggle:** Toggles on and off the radar and FLIR FOV cues.

**Expand mode:** See Expand Mode below.

**Scan center:** Shows the azimuth and elevation of the scan centerpoint. To change the scan center, see Changing Radar Scan Centerpoint below.

**HAFU symbol:** MSI tracks are shown as HAFU symbols (see HAFU Symbology above). L&S and DT2 target information is the same as the Attack and SA formats.

**Target data:** Data for the L&S, or the track currently under the cursor. Includes closure velocity, range to target, and target heading.

**Reset:** Exits expand mode and re-prioritizes MSI trackfiles (same function as on the Attack Radar format).

**Azimuth-only contacts:** Contacts without elevation data are shown here in the "dugout."

**ID option:** Determines the type of data shown in the HAFU datablock. Toggles between FULL (radar and MSI data), RDR (radar data only), and unboxed (datablock hidden). This function, and the HAFU datablock, are not yet implemented.

**CIT interrogation type:** Changes the type of automatic interrogations initiated by the combined interrogator/transponder (CIT). Options are ALL (all IFF modes), SNGL (a selected IFF mode), and CC (correct code, like SNGL but requires a specific SIF code). Not yet implemented.

**CIT azimuth:** Changes the horizontal extent of manual and automatic CIT interrogations. Cycles between 20°, 40°, 80°, and 140°. Not yet implemented.

**CIT FOV:** Indicates the azimuthal extent of manual and automatic interrogations made by the CIT. Not yet implemented.

**CIT range:** Shows the maximum range for manual (not automatic) CIT interrogations; returns beyond this range are not displayed. The up and down arrows change the range. Options are 5, 10, 20, 40, 80, and 100 NM. Not yet implemented.

**Auto interrogation:** When boxed, automatically performs a single pointed CIT interrogation whenever a new L&S is designated, when the L&S is stepped, or when a HACQ/LACQ is attempted. Not yet implemented.

**L&S interrogation:** When boxed, automatically performs continuous pointed CIT interrogations on the L&S (whenever an L&S is designated). Not yet implemented.

**IFF declutter:** When boxed, suppresses display of new CIT tracks, and allows existing tracks to age out. Not yet implemented.

**Display stores:** Displays the STORES page when pressed.

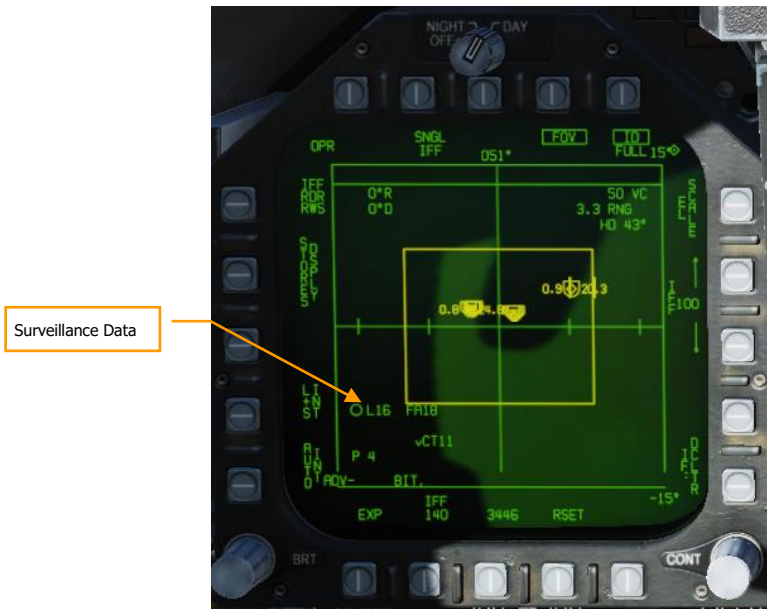

**Surveillance Data.** This datablock displays information for each sensor that is contributing data to the multi-sensor integration target under the cursor. In the screenshot above, the first line depicts a friendly HAFU symbol and aircraft type of F/A-18C provided by DL16. The second line indicates the DL16 pilot ID ("COLT1-1"). The third line displays "P" indicating the presence of a PPLI track for this target, and "4" to indicate a friendly mode-4 reply.

## Expand Mode

The AZ/EL expand mode can be entered by pressing PB20, labeled EXP. The expand mode is continuously centered on the L&S.

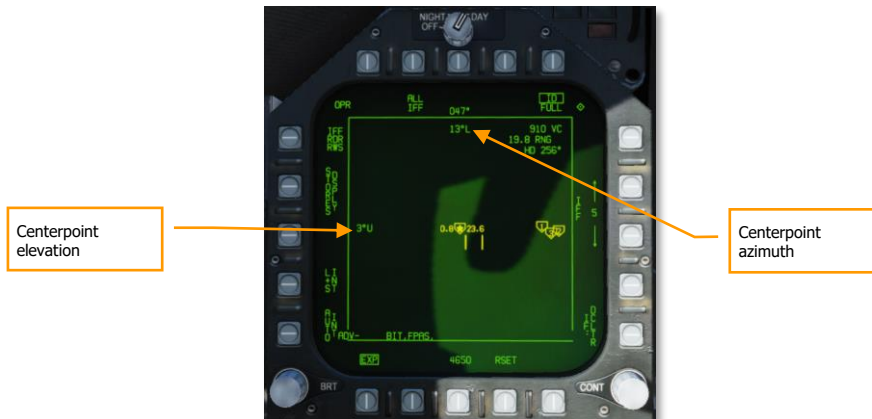

Figure 93. AZ/EL Expand Mode

The azimuth and elevation of the FOV centerpoint are shown at the top-center and center-left of the display area. The FOV in expand mode is always 20° in azimuth and 5° in elevation.

To exit expand mode, press PB20 to unbox the EXP label.

## FLIR Sensor Mode

When the FLIR is selected as the active sensor, the AZ/EL format changes slightly, and some pushbuttons have different functions.

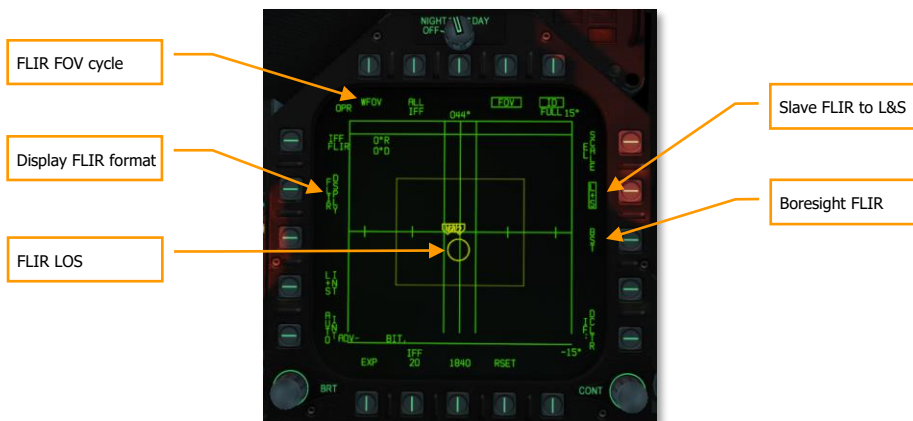

Figure 94. AZ/EL Format with FLIR

**FLIR FOV cycle:** Cycles between available FLIR fields of view: WFOV (wide), MED (medium), and NFOV (narrow).

**FLIR LOS:** Indicates the FLIR line-of-sight. Note that the circle does not display the FOV area, as this would be excessively small. The circle will enclose a HAFU symbol when the FLIR is slaved to a trackfile. This circle is dimmed when RDR is the selected sensor.

**Display FLIR format:** Pressing this pushbutton displays the FLIR format.

**Slave FLIR to L&S:** Boxing this option will keep the FLIR LOS slaved to the current L&S.

**Boresight FLIR:** Pressing this button drives the FLIR LOS to boresight. Because the AZ/EL view is horizon-stabilized, but the boresight LOS is not, changes in aircraft pitch will cause the LOS circle to drift up and down.

## HOTAS Controls

The AZ/EL page can be quickly brought up using the HOTAS when it is not already displayed. When in A/A master mode, bumping the Sensor Control Switch left will put the AZ/EL page on the left DDI, if the left DDI cannot take TDC priority (e.g., the Stores format).

Pressing the TDC designate when the cursor is over an MSI trackfile designates that target as the current L&S. If an L&S is already designated, the trackfile under the cursor is designated the DT2. If the target under the cursor is the DT2, pressing TDC designate will make it the L&S, and the previous L&S will be erased. (It will not be downgraded to DT2.)

When the sensor mode is set to FLIR, releasing TDC designate when the cursors are over a trackfile commands the FLIR LOS to that trackfile. The FLIR will continuously track that target, even when the L&S changes. Boxing the L+S pushbutton (see FLIR Sensor Mode, above) will return FLIR LOS to the L&S.

Pressing and holding TDC designate when the cursor is not over an MSI trackfile, but in the display area, changes the cursor to a pointing cross. See Changing Radar Scan Centerpoint, below.

Bumping the Sensor Control Switch in the direction of the DDI showing the AZ/EL format commands the radar to attempt single-target track (STT) on the MSI trackfile under the cursor. If the radar is already in STT mode, bumping the Sensor Control Switch in this manner commands a break-lock.

## Changing Radar Scan Centerpoint

Pressing and holding TDC Designate when the cursor is not over a HAFU symbol will change the cursor to a pointing cross, which can be slewed using the TDC.

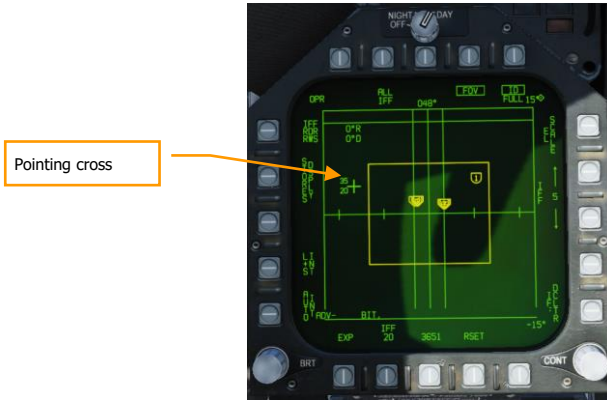

Figure 95. AZ/EL Pointing Cross

To the left of the pointing cross are the minimum and maximum altitudes (in thousands) for the radar scan volume at one-half the range selected on the Attack Radar format. For example, if the radar range is currently 40 NM, the altitudes shown next to the pointing cross represent the minimum and maximum altitudes of the radar scan volume at 20 NM. If the active radar mode is VS (velocity search), the altitudes shown are at a fixed range of 40 NM.

If FLIR is the selected sensor, only one altitude is shown adjacent the pointing cross, representing the altitude along the FLIR LOS at one-half the selected range on the Attack Radar format.

Releasing TDC Designate re-centers the radar scan volume in the location of the pointing cross and reverts the pointing cross back to a cursor.



# AIR-TO-GROUND RADAR

As with the Air-to-Air mode, the RADAR switch on the SNSR panel must first be set to the OPR selection. Once supplied power, the operating status will first display NOT READY legend for 30 seconds and then ORT TEST for 2.5 minutes. After 2.5 minutes, TEST is removed and replaced with either STBY, OPR, or EMERG depending on the power switch setting. When airspeed/ground speed is less than 80 knots, the transmitter is inhibited (indicated by Iron Cross).

The radar AG mode can be selected two ways:

- Selection of the AG Master Mode button. AG radar can also be displayed in NAV mode
- Selection of SURF from the radar air-to-air mode puts the radar in MAP mode of the AG radar at a 40 nm range.

## Display Controls

As with Air-to-Air mode, TDC assignment is indicated by the diamond symbol in the top right corner of the display. TDC assigned is created using the Sensor Control Switch in the direction of the DDI display the AG radar page.

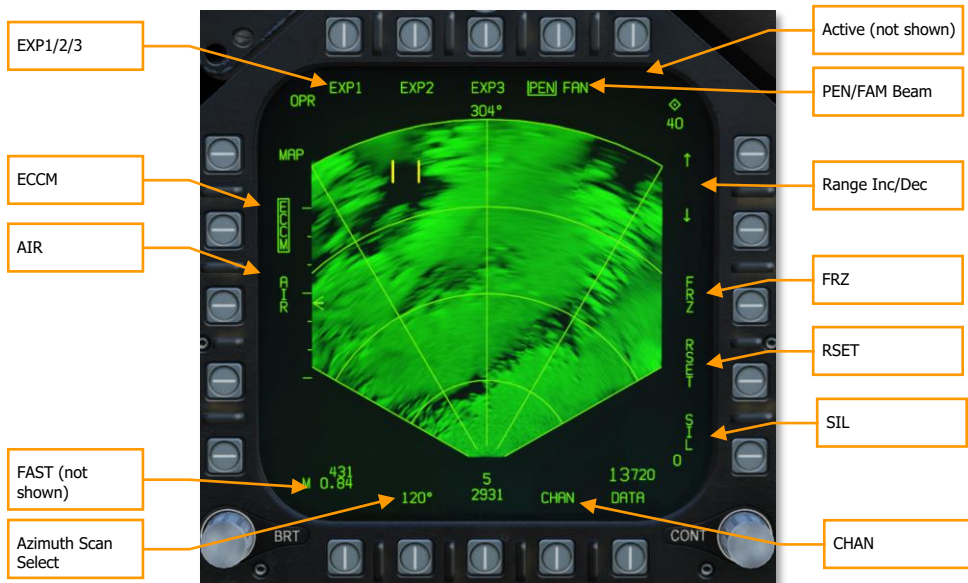

**ECCM.** This has no function in the simulation and is a static label.

**AIR.** Pressing the AIR pushbutton puts the radar in air-to-air mode RWS mode.

**FAST.** When building an image in a DBS mode, selecting FAST decreases the image rendering time three times faster, but reduces the resolution.

**Azimuth Scan Select.** The azimuth select pushbutton can select azimuth sector scan patterns of 20°, 45°, 90°, and 120° with sequential presses. Upon pressing the button at 120°, the selection wraps back to 20°.

**SIL (Silent).** When selected (boxed), the video display is frozen, the radar does not transmit, displays ACTIVE indication, and the FRZ label is boxed. When disabled (unboxed), the radar resumes normal operation. SIL is not available in PVU and TA modes.

**ACTIVE.** When in SIL mode, the ACTIVE option is displayed, and when pressed, will complete one antenna scan frame.

**RSET (Reset).** The reset option is available in the MAP, SEA, GMT, EXP1, EXP2, and EXP3 modes, and when pressed, reinitializes the video gain, pencil or fan beam, and antenna elevation angle for the selected range when no designation or offset has taken place.

**FRZ (Freeze).** If enabled and SIL is not boxed, the display video is frozen and FRZ is boxed. When deselected (unboxed), the display video is updated normally. FRZ does not stop transmission, only SIL mode will.

When SIL is enabled, selection of the boxed FRZ option will command the radar to blank the video in the display area and the box is removed around FRZ. Video will not be displayed until an active scan is done by either selection of the ACTIVE option or until silent is deselected.

FRZ is available in all modes but TA, PVU, and AGR.

**Range Increment and Decrement.** Up and down arrows are next to the pushbuttons and pressing the up arrow increases range and pressing the down arrow reduces range. Range scales include 5, 10, 20, 40, 80, and 160 nm. Pressing the down arrow with 5 nm selected has no effect and pressing the up arrow with 160 nm selected has no effect. Ranges can be set in the MAP, SEA, GMT, and TA modes.

Range selection is not available if there is an OAP or designated target, and instead will automatically base the range on the OAP or designation when the target exceeds 93 percent/45 percent of the range scale.

Range scale options include:

- MAP - all scales
- SEA - 5, 10, 20, 40, and 80 nm
- GMT - 5, 10, 20, and 40 nm.
- TA - 5 and 10 nm.
- GMT/MAP INTL - 5, 10, 20, and 40 nm
- SEA/MAP - All scales, but targets shown only to 80 nm.

**PEN/FAN (Pencil/Fan) Beam.** Either a pencil or fan radar beam can be used for the scan by consecutively pressing this pushbutton between PEN and FAN when in MAP, GMT, SEA, EXP1, EXP2, and EXP3 modes. Different modes have different default beam modes. When in MAP, SEA, or GMT modes and the antenna is greater than 5.5° down, FAN mode is automatically selected. If in EXP1 mode, FAN is automatically selected if the angular amount of the ground coverage is greater than 5.5°. In EXP2 and EXP3 modes, PEN mode is boxed, and FAN mode cannot be selected.

**EXP1/EXP2/EXP3.** When the radar is operating in MAP mode, EXP1, EXP2, and EXP3 options are displayed. If there is no OAP or designation, selecting an EXP mode removes acquisition cursor from the display and the EXP indicator is superimposed on the MAP display. This is termed MAP W/SECTOR, MAP/PATCH, and MAP W/SAR. The TDC is used to position the EXP scan area on the MAP. This is done by depressing and holding down the TDC switch to slew the EXP area and then releasing the switch to begin the EXP scan and display of the selected MAP area. The selected EXP mode is boxed.

If a designated target or OAP exists, selecting an EXP mode initiates an EXP scan and display that is centered on the target/OAP.



If already in EXP 1 and either EXP 2 or EXP 3 is selected with no OAP or designated target, the EXP 2/EXP 3 scan area is superimposed over the EXP 1 area. This is done by depressing and holding down the TDC switch to slew the EXP area and then releasing the switch to begin the EXP 2/3 scan and display of the selected EXP 1 area.

If already in EXP 1 and either EXP 2 or EXP 3 is selected with an OAP or designated target, the EXP 2/EXP 3 scan is centered on the OAP or designated target.

If already in EXP 3 and EXP 1 or EXP 2 is selected, an EXP 1 scan is initiated that is centered on the EXP 3 area.

EXP 1 and 2 are limited to 40 nm and EXP 3 is limited to 30 nm.

## AG Radar Display

The AG radar display consists of the following elements:

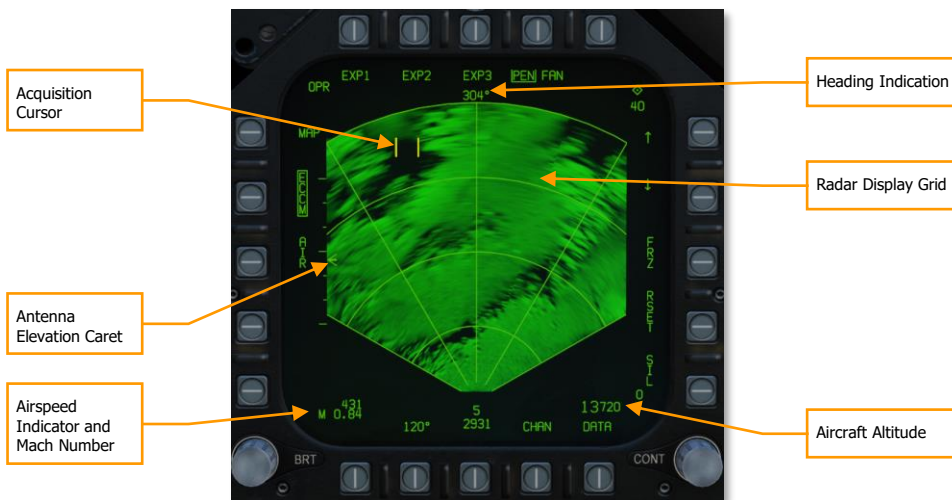

**Antenna Elevation Caret.** This caret indicates the radar antenna elevation in the vertical plane. It is pitch and roll stabilized to the aircraft's own horizon. The elevation is controlled by the radar elevation control on the throttle.

**Radar Display Grid.** The azimuth and range grid lines and range arcs are displayed in the tactical area and are displayed at  $0^\circ$ ,  $\pm 30^\circ$ , and  $\pm 60^\circ$ . The four range arcs separate the range setting into four equal range segments. When in an EXP mode, the expanded areas cover  $45^\circ$  in azimuth for EXP1 and EXP2 covers  $12^\circ$  in azimuth. Coverage of EXP3 is based on range.

**Acquisition Cursor.** This cursor consists of two parallel, vertical lines and is the same symbol as the air-to-air radar TDC cursor. It can be used in the non-tactical area to select options and designate in the tactical area. It has both slew and press/release functions. When the radar is in a tracking mode, the cursor is no longer visible.

**Aircraft Altitude.** In the lower right corner of the display, the aircraft's altitude is displayed in increments of 10 feet. This operates the same as on the air-to-air radar display.

**Mach Number.** The aircraft Mach to the nearest hundredth is displayed in the bottom left corner.

**Airspeed Indicator.** Calibrated aircraft airspeed is displayed in increments of 1 in the lower left corner of the display.

**Heading Indication.** The aircraft's magnetic heading is displayed in the top center of the display in the following modes: MAP, SEA, SEA INTL, GMT, GMT INTL, and TA.

## HOTAS Controls

The four HOTAS controls to manipulate the AG radar are the TDC, radar elevation control, the sensor control switch, and the undesignate/nosewheel steering switch.

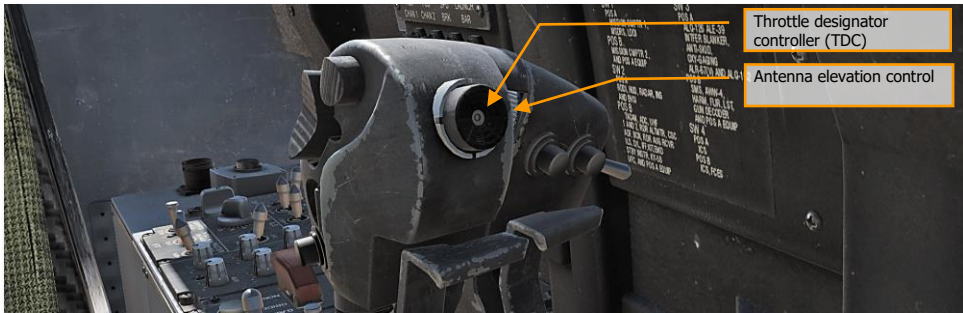
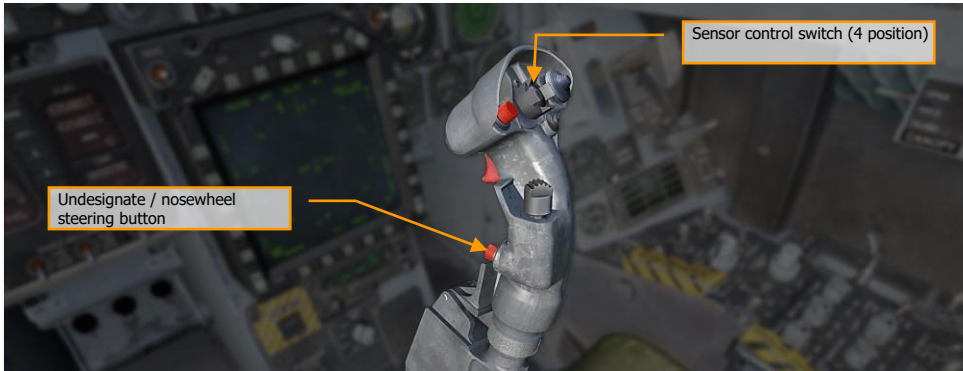

### TDC

If assigned to the AG radar display, it can be used in the non-tactical area to select options. Non-tactical "zones" that the TDC can be placed to display and initiate options include:

- Mode select
- Map gain increase/decrease select
- AIR select
- SURF select
- Azimuth scan select
- SIL select
- RSET select

- Range increment and decrement select
- ACTIVE select
- PEN/FAN select
- EXP1/EXP2/EXP3 select
- INTL select

When in the tactical area while operating in MAP, GMT, or SEA modes, a press and release sets a designation. When pressed, the acquisition cursor is blanked, and the in-video cursor appears. When the TDC switch is released, the stabilized cue is displayed at the in-video cursor intersection. Once a designation is made, the range increment/decrement and the reset options and symbols are removed from the display. Additionally, radar antenna elevation cannot be adjusted.

### *Radar Elevation Control*

When in MAP, GMT and SEA, rotation of this control adjusts the antenna elevation angle.

### *Sensor Control Switch*

This switch is used to assign the TDC to a display. If the radar is on the right DDI and the switch is moved to the right, the TDC is assigned to the right DDI with the radar display, and conversely with the left DDI.

If the TDC is already assigned to the DDI with the radar display, pressing the switch again in the direction of the radar display commands an acquisition on press and a track on the release.

If already tracking, the sensor control switch can be held (pressed) in the direction of the DDI with the radar display, and the TDC can then be used to slew the in-video cursor. Upon release of the sensor select switch, the radar will attempt to track the new location.

If the radar is in track mode, pressing the sensor control switch to the right will break lock on an FTT or GMTT track and the radar will return to search mode (MAP, GMT, or SEA).

When the sensor control switch is pressed forward, it assigns the TDC to the HUD and the radar is placed in AGR mode if the radar is not tracking.

### *Undesignate/Nosewheel Steering Switch*

If tracking when pressed, this switch will command the radar back to search mode and undesignate the aimpoint.

## AG Radar Search Modes Operation

The master modes of the AG radar include and are cycled by presses of the Mode Select pushbutton (MAP > GMT > SEA > TA > MAP):

- Real Beam Ground Map (MAP). This is the initialized, default mode.
- Ground Moving Target (GMT)
- Sea Surface Search (SEA)
- Terrain Avoidance (TA) later in early access.

Other modes and sub-modes include:

- GMT/MAP Interleave (INTL)
- SEA/MAP INTL

- Doppler Beam Sharpening (DBS)
  - Expand 1 (EXP1) Sector
  - Expand 2 (EXP2) Patch
  - Expand 3 (EXP3) SAR

### *MAP Search Mode*

The MAP mode is used to illuminate the terrain and acquire large discrete ground objects. It can rapidly map large areas to identify landmarks for designation. Returns are displayed over eight, separate intensity levels to create a picture. The picture is created by radar reflections off the terrain and objects and back into the antenna for processing. MAP is displayed in a PPI format with zero range at the bottom of the display and the range setting at the top of the display. Lateral displacement of returns is from the centerline of the aircraft.

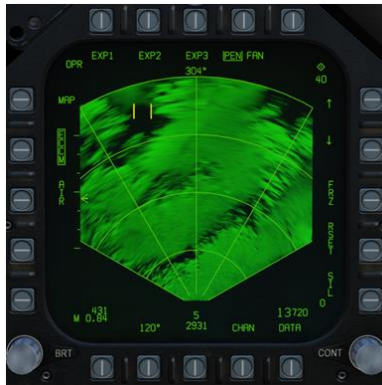

Possible azimuth settings include 20°, 45°, 90°, and 120°. Range settings are from 5 to 160 nm.

The antenna scan is pitch and roll stabilized.

### EXP Modes

From MAP mode, EXP1, EXP2, and EXP3 Doppler beam sharpening modes can be selected from the top option buttons.

As the radar first scans the selected region, it builds the first frame. With each new frame, the image is updated which can take several seconds. The time to create a frame is inversely proportional to the angle of track and can vary from 3 to 8 seconds (the closer the frame is to aircraft heading, the longer it will take). However, the FAST option can be enabled to decrease frame creation time, but image quality will suffer.

**EXP1** provides a higher resolution picture of a selected MAP sector.

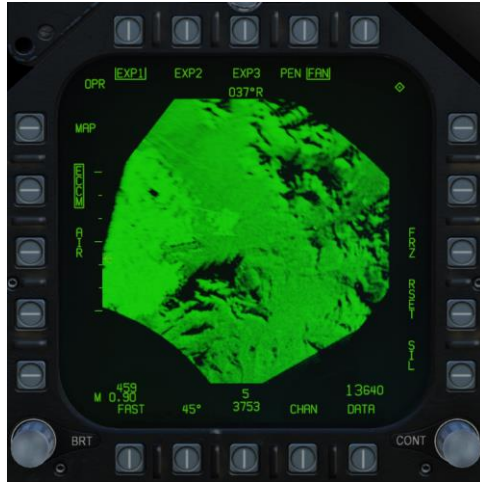

As noted earlier, the EXP1 azimuth is 45° and EXP2 is 12.6°. Due to Doppler frequency shift, the mapped areas to the side of the picture will be better formed than those directly in front of the aircraft. As such, DBS maps (EXP1 and EXP2) are generally created to the side of the aircraft heading.

**EXP2** provides the next highest resolution of a small area.



**EXP3** provides the highest resolution and uses Synthetic Aperture Radar (SAR) processing to create the image.

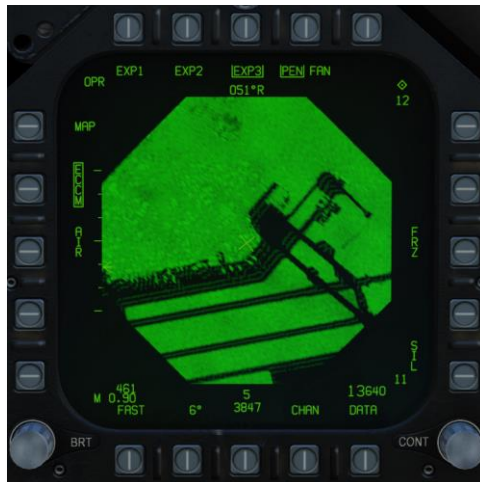

When EXP3, the display is converted to a B-scan format (square), the top of the display is still oriented toward the relative direction of the patch being mapped. The maximum and minimum ranges covered in the sector/patch are displayed in the top and bottom of the radar display on the right side of the DDI.

If in EXP3 and the range to a designated stabilized target is less than 5.7 nm, the display changes to EXP2. If the range is then less than 3.0 nm, EXP1 is automatically selected.

### GMT and GMTT Modes

The Ground Moving Target (GMT) mode scans for and highlights moving targets, detected by their Doppler shift. Detected targets are displayed as bricks:



The shaded area of the display shows antenna azimuth coverage.

Moving the TDC over the target brick and pressing the SCS in the direction of the MPCD will command acquisition of the target. Releasing the SCS will command track. The radar mode will change to Ground Moving Target Track (GMTT) and additional target information will be displayed:



Pressing the Undesignate button will return the radar to GMT mode.

The GMT and MAP modes can be interleaved by pressing the INTL pushbutton (PB 6). The mode will change to GMT/MAP, and the radar will alternate between MAP and GMT modes. Moving targets will be overlaid on the map.

The GMT radar mode can be used in 5, 10, 20, and 40 nautical mile ranges. GMTT is effective out to about 10 nautical miles.

### *SEA Mode*

The SEA mode is suitable for detecting ships and small islands at low sea states. Filtering is applied, scan rate is reduced, and target integration time is lengthened to compensate for scattering caused by the sea surface.

SEA mode uses the same symbology and HOTAS commands as GMT and GMTT modes (documented above). Ranges of 5, 10, 20, 40, and 80 nautical miles are available.

SEA/MAP interleaved mode is available just as with GMT/MAP. In SEA/MAP mode, the 160 NM range is available for mapping, but seaborne targets will only be presented out to 80 nautical miles.



### *A/G Ranging (AGR) Mode*

AGR mode is not manually selected, but rather enabled by the Mission Computer automatically under the following conditions:

- When A/G master mode and the TDC is assigned to the HUD with bombs, rockets, or guns selected while in CCIP mode.
- When in NAV or A/G master modes when a HUD, FLIR, or TGP designation is made.
- When in NAV or A/G master modes when AGM-65 is in track mode and the TDC is assigned to the HUD.

In these cases, the radar in AGR mode is providing the ranging information to the MC for weapon employment calculations. The radar is slaved to the gun or rocket reticle, CCIP impact point of the bomb, or FLIR LOS.

On the display, the target range is displayed in feet, and the velocity (VEL) error is displayed. The error in knots is the difference between the target closing velocity measure by the radar and the best available aircraft velocity measured along the radar LOS.

Although AGR is displayed next to the mode button, the button has no function when in AGR mode.

## Radar Tracking Designations

Offset Aim Points (OAP) and targets can be designated manually on the radar display that include navigation stabilized cursor designation and radar track designation. Radar track designations are only available in MAP, SEA and GMT modes. Navigation stabilized cursor designation is available in all modes.

A designation that is less than 10 nm will become a stabilized cue. If the stabilized cue is outside the radar azimuth, it is removed.

### *Navigation Stabilized Cursor Designation*

When in any of the modes, the TDC can slew the acquisition cursor (two parallel, vertical lines) on the display. Once the TDC is depressed and held, the designation cursor (intersection of range and azimuth lines that span the entire tactical area) replaces it.

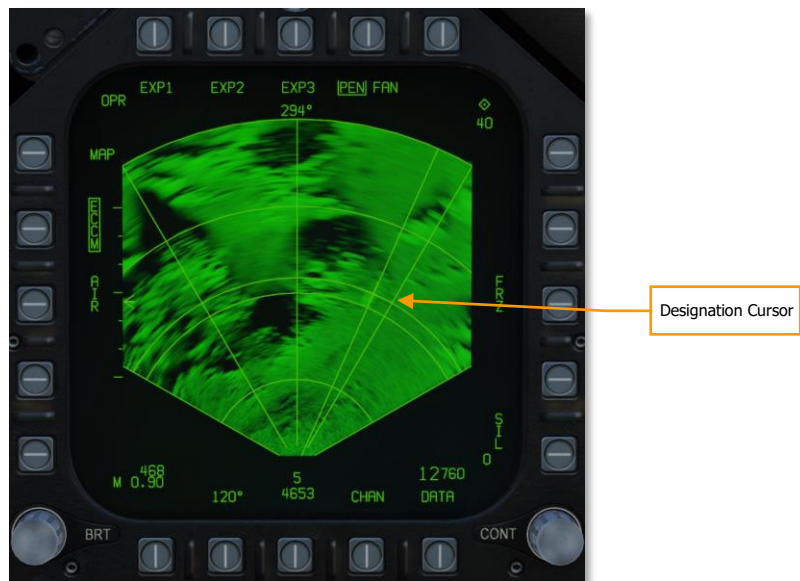

While the TDC switch is held depressed, the designation cursor can be slewed with the TDC. When the TDC switch is released, the designation cursor is designated and stabilized and is replaced with the stabilized cue. The acquisition cursor also now reappears and can be slewed with the TDC.

This process creates a designation point from which an AUTO attack could be initiated. And is also indicated on the HUD as the designation point and steering indicator on the heading tape.

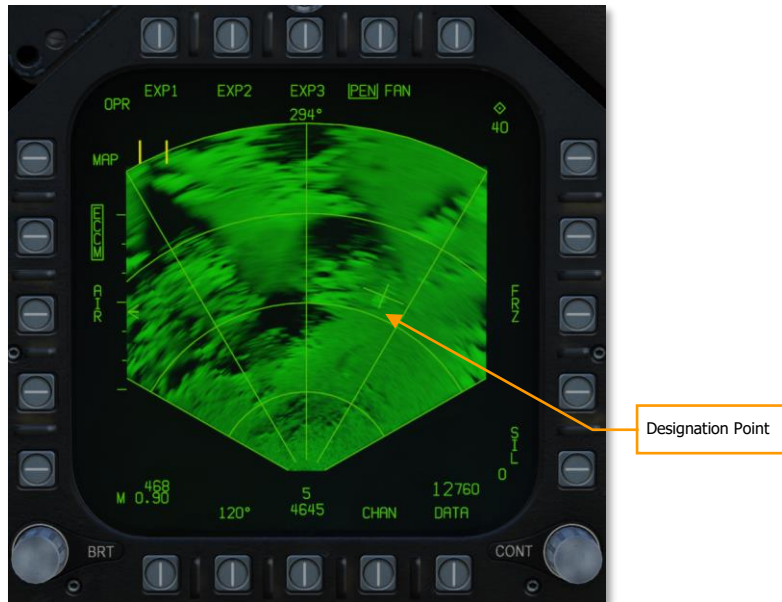

When a designation is made, the range increment and decrement options are no longer displayed, and the display will automatically adjust display range scale to keep the stabilized cue within 93%/45% of the selected range scale. The antenna elevation cannot be adjusted with a stabilized cue and the RSET option is removed.

With a stabilized cue with a weapon in AUTO mode, the weapon Time to Release is also displayed to match the HUD.

# DL16 DATALINK



# DL16 DATALINK & MIDS

The F/A-18C for our simulation relies on two Multifunction Information Distribution System (MIDS) terminals that allows the transmission and reception of data over the DL16 Tactical Datalink (TDL) network. DL16 allows multiple aircraft types to share data with each other. In addition to data transfer, DL16/MIDS also supports secure voice (MIDS 1 and MIDS 2 on throttle radio switch). Both the lower and upper radio antennas support the MIDS terminal.

The primary purpose of DL16/MIDS is to provide a near-real-time picture of the tactical area around the pilot's aircraft. This includes ownship sensors, other friendly fighters on the network, and surveillance assets like AWACS. All of these sensor sources are then correlated to create a unified situational awareness picture. This in turn allows a more coordinated engagement and less chance of fratricide. It can display up to 16 separate trackfiles.

MIDS can receive and display to the pilot three types of trackfiles over DL16 to the MIDS terminal:

- **Fighter-to-Fighter (F/F)**. MIDS can receive up to seven donors (other fighters providing track data) and each donor can share up to eight trackfiles. These are all correlated against each other to avoid duplicate trackfiles.
- **Precise Participant Location and Identification (PPLI)**. This is the data that allows the display the location of the donor, what its sensors are doing, and payload remaining.
- **Surveillance Tracks (SURV)**. These are non-fighter aircraft data sources like AWACS and radar ground stations.

Trackfiles from each of these three sources (offboard) are then correlated with the sensors of the player's aircraft (onboard). This is termed Multi Source Integration (MSI). Trackfiles that correspond to the player's aircraft are not displayed.

- Trackfile information can be displayed three ways:
- Air-to-Air Radar Display
- Situational Awareness (SA) Display
- Joint Helmet Mounted Cueing System (JHMCS)

For this simulation, all network options will be configured automatically.

## MIDS MFD Format

The MIDS MFD format is available from the SUPT Menu.

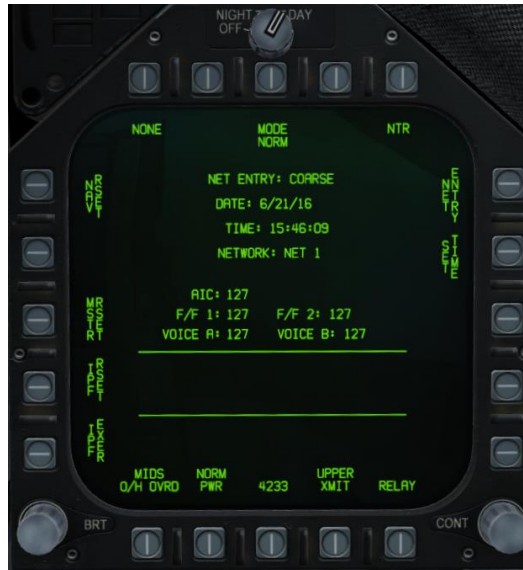

*Figure 96. MIDS MFD Format*

This format will be documented in a later edition of this manual.

## MIDS DL16 UFC Control

To enter MIDS control on the UFC, the D/L button is pressed. Upon doing so, the UFC will appear as seen below:



Figure 97. Datalink (D/L) UFC

To enable power to the MIDS terminal, ON/OFF button on the UFC must first be pressed. When not powered on, the scratch pad and all option select windows are blank. Once powered on, ON appears in the scratchpad and the default indications on the option select windows:

- AIC
- F/F1
- F/F2
- VOCA
- VOCB

Turning MIDS off is done by pressing the UFC ON/OFF button a second time. The option select window of AIC, F/F1, and F/F2 has no function.

Pressing the option select button for either VOCA or VOCB allows the player to enter the MIDS voice channel for MIDS A and MIDS B. Upon selection, the keypad can be used to enter a channel number between 1 and 126. The entered channel is displayed in the scratch pad and the ENT button is used enable the set channel to the selected MIDS voice channel select. Selecting 127 turns off VOCA and VOCB.

## MIDS Secure Voice

In addition to the ARC-210 radio COMM1 and COMM2, MIDS two additional, secure radio transceivers, MIDS A and MIDS B. over MIDS A by pressing the Comms Switch forward, and over by pressing the Comms Switch aft.

Volume level of MIDS A and MIDS B is controlled by the knobs on the volume panel on the left console. Note that the switch should always be in the NORM position. If set momentarily to HOLD or ZERO, it will erase the secure radio for MIDS A and MIDS B.

## MSI Trackfiles

Multi-Sensor Integration (MSI) Trackfiles are objects (symbols which are generated either by external sources (F/F donors SURV), or by internal sensors (e.g., radar hits). Trackfiles are contacts which have been classified by the Mission Computer the pilot as "onboard" and/or from external donors as "offboard". These tracks are often represented on the screen by a symbol known as a HAFU.

When the Radar sweeps a track for the first time, the track is assigned a rank based on a number of basic factors and weighted according to things like range, speed and aspect in order to prioritize it in terms of a potential tactical threat.



provides  
Transmit  
MIDS B

volume  
CRYPTO

settings

and data)  
and  
radar  
and/or



# SITUATIONAL AWARENESS (SA) PAGE

The SA page is selected from pushbutton 13 (SA) on the TAC page. Upon selecting the SA page, the main SA page is displayed and, in many ways, duplicates the HSI page pushbutton options. Common HSI pushbutton elements include:

- MAP, pushbutton 6
- SCL, pushbutton 7
- MK2 (Mark) Point, pushbutton 9
- DCNTR (Decenter display), pushbutton 10
- WYPT/OAP/TGT, pushbutton 11
- Up Arrow (increment waypoint), pushbutton 12
- Down Arrow (decrement waypoint), pushbutton 13
- WPDSG (waypoint designate), pushbutton 14
- SEQ (1-3) (sequence), pushbutton 15
- AUTO, pushbutton 16
- MENU/TIME, pushbutton 18

All the above will function as they do on the HSI page, and changes on the HSI will translate to the SA page and vice versa.

Interior to the SA display also has much in common with the HSI display that includes:

- Compass Rose
- Lubber Line
- Waypoint/OAP/TGT Head and Tail
- TDC BRA to A/A Waypoint
- Ownship BRA to A/A Waypoint
- Aircraft Symbol
- TDC assignment symbol
- Air-to-Air Waypoint (bullseye)
- Selected Waypoint/OAP/TGT bearing, range, and time to (top right)
- Selected TACAN bearing, range, and time to (top left)

Unique pushbutton functions to the top-level SA page include:

- **DCLTR** (declutter), pushbutton 7. Upon selection, five declutter options are made available via pushbuttons 6 to 10.
  - OFF. All symbols are displayed
  - REJ1. The following items are hidden: compass rose, lubber line, and SAM rings
  - REJ2: The following items are hidden: REJ1 items and Waypoint/OAP/TGT data, TACAN data, waypoint head and tail, and TACAN head and tail
  - MREJ1: Hide air defense symbols (SAM and AAA) and rings
  - MREJ2: Hide surface unit symbols



Figure 98. SA Page Top-Level

Unique functions in the tactical area of the top-level SA page include:

**Sensors Sub-Level.** Press pushbutton 5 to select the Sensors sub-level page.

**Countermeasures.** In the bottom left corner of the SA page are four bars that graphically indicate the number of remaining countermeasures. To the left of each bar, from top to bottom:

- C for chaff and remaining number
- F for flares and remaining number
- O1 for GEN-X and remaining number
- O2 for GEN-X and remaining number

Each bar is filled based on the initial loaded. For example: if the mission starts with 60 flares and 30 have been used, the bar is ½ filled.

**Air Defense Zones.** If a hostile air defense unit is placed in the mission, and not to be hidden, it will appear on the SA display at its geographic location. The system is indicated by two alphanumeric (same as from EW display) with a ring around it that equates to the engagement range (same as indicated in the mission editor and F10 view).

**EW Symbols.** EW information is not correlated with an MSI track, it is only based on ownship detection. Only the four highest threats are displayed on the SA page and can only be airborne interceptor (AI) threats, friendly detections, and unknown detections. At the top of the symbol are 1 to 3 lines that indicate threat level:

- One line: Non-lethal threat

- Two lines: Lethal threat
- Three lines: Critical threat and will flash

The character code in the center of the symbol is the same as displayed on the EW/RWR display.



**Transmit designation.** When TXDSG is boxed, lines will be drawn between flight members/friendly donor aircraft and their air-to-air or air-to-ground L&S designations:



## SA Sensor Sub-Level



Figure 99. SA Page Sensors Sub-Level

Upon pressing the SENSUR pushbutton on the SA Top Level, the player is moved to the SA Sensor page. On this page, the player can filter the sources of information that go into creating the MSI picture.

**RWR Select.** Pushbutton 7. Successive presses of pushbutton 7 cycles through the options of the lethality level of RWR contacts will be displayed on the SA page. In addition to the three boxed options, there is a fourth unboxed option in which no threat RWR is displayed.

- RWR ALL. All displayed under RWR option that includes non-lethal, lethal, and critical detections displayed.
- RWR CRIT LETH. Only lethal and Critical detections displayed.
- RWR CRIT. Only critical detections are displayed.

**FRIEND Select.** Pushbutton 8. Successive presses of pushbutton 8 cycle the presentation of friendly RWR detections:

FRIEND  
OFF

FRIEND  
NO ID

FRIEND  
RWR ID

**Return to SA.** Pushbutton 10. Returns the display to the SA Top Level.

**Unknown Filter (UNK).** Pushbutton 9. Pressing pushbutton 9 toggles unknown HAFU symbols on the SA page. When boxed, unknown HAFUs are displayed.

**Fighter Donors (F/F).** Pushbutton 12. When selected and boxed, track information from other fighters with JTIDS/MIDS will be displayed. If not selected, no information from donor fighter aircraft will be displayed.

**PPLI.** Pushbutton 13. When selected and boxed, location and information about other flight members and other friendly aircraft with JTIDS/MIDS terminals will be displayed. If not selected, no information from these aircraft will be displayed.

**Surveillance Donors (SURV).** Pushbutton 14. When selected and boxed, track information from AWACS aircraft will be displayed. If not selected, no information from AWACS aircraft will be displayed.

## HAFU Symbology

Contacts on the SA page are displayed as HAFUs (Hostile, Ambiguous, Friendly, or Unknown). They consist of multiple components that can include:

- Color: Green for Friendly, Yellow for Unknown, and Red for Hostile
- Top Half: The top half of the symbol indicates identification from your onboard sensors
- Bottom Half: The bottom half of the symbol indicates the identification by offboard sensors (donors)
- Threat Rank: If the contact is detected by your sensors and is an Unknown or Hostile, its threat rank is displayed as a number in the center of the HAFU
- Vector: A line leading from the HAFU indicates the contacts direction of travel
- Shape: The top and bottom elements of the HAFU can have three shapes:
  - Hemisphere: Friendly
  - Bracket: Unknown
  - Caret: Hostile

### *PPLI SA Symbols*

Aircraft that incorporate DL16 datalink equipment (MIDS or JTIDS radios) can broadcast their location to other aircraft over the same network. The Precise Participant Location and Identification (PPLI) indicator on the SA page shows their location, and a TDC cursor over the contact displays its information in the lower, right data block.

Based on the ability of the unit to share data over the network, its symbol will vary:



Basic PPLI symbol. Basic location with no sensor sharing.



Command and Control PPLI symbol (AWACS). Location with surveillance (SURV) sensor sharing.



PPLI donor symbol. Location with fighter (F/F) sensor sharing.

Notes:

- PPLI symbols have a stem indicating heading.
- The PPLI symbol with dot in the center for a C2 unit is the AWACS aircraft (E-2 or E-3).
- All AI aircraft with JTIDS or MIDS terminals can act as donors (indicated as dot on left side of circle).

- Only player flight will have a wingman on-channel identifier in the center of the symbol. Player is A, Wingman 2 is B, Wingman 3 is C, and Wingman 4 is D.
- Display of PPLIs can be toggled by pressing pushbutton 14 on the sensors sub-level of the SA page. This can be used to help declutter the display.

### *Onboard Sensor SA Symbols*

Information pertaining to contacts that are only detected by your onboard sensors (radar) is indicated by the top half of the symbol. Color and shape indicate its "side". There are two ways to identify a contact just using onboard sensors:

**Mode 4 Identify Friend or Foe (IFF).** This function uses the F/A-18C's built-in IFF system to interrogate the contact with a coded pulse interrogation. If the contact returns the correct reply, the contact is deemed friendly (green and hemisphere). If the contact does not return a correct interrogation, then the contact is deemed unknown or hostile (if NCTR prints the contact as hostile).

**Non-Cooperative Target Recognition (NCTR).** Once an STT lock is made on the contact and NCTR is enabled from the radar RWS format page, an NCTR print can be made if the contact is within 25 nm and within 30° off the contact's nose or tail.

To classify a contact as hostile BOTH identifications be made. A truly hostile contact that is just identified with one identification will be displayed as unknown.



Friendly (green and hemisphere) contact only using onboard sensors



Unknown (yellow and bracket) contact only using onboard sensors



Hostile (red and caret) contact only using onboard sensors

Because onboard sensors are involved in the identification, the threat rank is included in the center of the HAFU. This is used for target sorting priority and determine the order in which a contact is locked using the AACQ mode.

As noted, a truly friendly contact only requires a Mode 4 identification to be classified as friendly, it does not also require an NCTR print.

### *Offboard Fighter-to-Fighter SA Symbols*

Donor F/F symbols that can be displayed on the SA page include both hostile and friendly elements. These are part of the lower half of the HAFU. If it is a F/F only contact, there will be no threat rank displayed.

The HAFU includes a stem that indicates the contact's direction of travel.



F/F donor friendly symbol



F/F donor hostile symbol

### *Correlated Onboard Sensor and Offboard F/F and SURV Tracks*

Contacts that detected by both your onboard sensors and offboard sensor(s) will have both upper and lower elements to the HAFU symbol. This is termed a correlated contact. The color of the contact is based on the onboard sensor identification and includes a threat rank unless the contact is determined friendly.

Note that if the onboard identification is different than an offboard identification, then the HAFU can be mixed. This is termed an ambiguous contact. For example: if the player has a contact on their radar that has no IFF identification, then the HAFU will be unknown. If an offboard donor (F/F or SURV) classifies the contact as hostile though, the HAFU would have a rectangular top but a triangle bottom. In this way, there are many potential HAFU combinations.



Ambiguous contact, onboard seen as unknown and offboard seen as friendly



Ambiguous contact, onboard seen as unknown and offboard seen as hostile



Correlated friendly contact



Correlated hostile contact

### *Offboard Surveillance (SURV) SA Symbols*

An additional HAFU type are contacts only detected by a surveillance (SURV) asset. These contacts are seen by an AWACS but not by you. These can be useful when you wish to run radar silent.

Contacts appear as either friendly (green circle) or hostile (red diamond) with a vector stem. These symbols are  $\frac{3}{4}$  the size of the other HAFUs.





SURV donor friendly symbol



SURV donor hostile symbol

Notes:

- For aircraft, the symbol also has a stem to indicate direction of travel.
- If a SURV track correlates to an F/F track, the F/F track symbol is displayed.
- If a SURV track correlates to an onboard only sensor track, an F/F symbol is displayed that indicates onboard and offboard tracking.
- SURV symbols are only displayed if not correlated with PPLI, F/F, or onboard sensor.
- If SURV tracking is lost on a contact, the symbol flashes at 3 Hertz for six seconds. If tracking is not re-established, the contract is removed from the SA page.

### *Ranking of Target Symbols*

Each trackfile HAFU is ranked from 1 to 16 if tracked by ownship sensors. The greater the potential threat, the lower the rank number. Factors that affect the rank include:

- Range
- Aspect
- Airspeed

## Target Under Cursor (TUC) Data

When the TDC cursor is placed over a symbol on the SA page, information about the symbol is displayed in bottom right corner as seen below:

If friendly:

- Aircraft type. For example: F15
- Unit callsign (first and last letter of the name and number) / remaining fuel
- Unit bearing and distance to player aircraft



Figure 100. Friendly TUC Data

If hostile:

- Aircraft type. For example: SU27. NCTR print
- Unit ground speed / bearing
- Unit bearing and distance to player aircraft



Figure 101. Hostile TUC Data

If unknown:

- Unknown (UKN) identification
- Unit ground speed / bearing
- Unit bearing and distance to player aircraft



Figure 102. Unknown TUC Data

## Correlated HUD Indication

When an aircraft is locked in STT with datalink enabled, the HAFU "hat" will be drawn over the top of the TD diamond, if there is correlation of identify of the target from an offboard source.

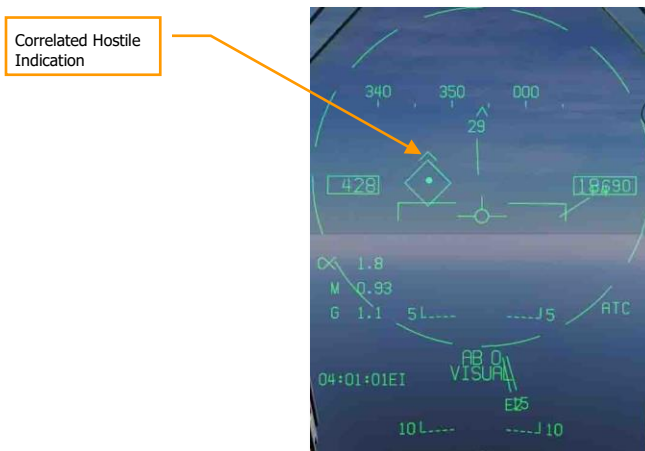

Figure 103. Correlated Hostile HUD Indication

# ADVANCED TARGETING FORWARD-LOOKING INFRARED (ATFLIR) POD



## AN/ASQ-228 ATFLIR

The Advanced Targeting Forward Looking Infrared (ATFLIR) pod is a slewable electro-optical pod with laser designation, ranging, and searching capability. It is capable of both video and infrared imaging, as well as moving target tracking. The ATFLIR is effective in both the air-to-ground and air-to-air role. The ATFLIR can only be mounted on the left cheek hardpoint, and weighs 424 lbs.

The ATFLIR is selected from the PB6 on the TAC page with the Master Mode set to A/G or NAV.

The ATFLIR camera is slewed using the TDC, when the TDC is assigned to the DDI displaying the FLIR format. As with other formats, a small diamond appears in the top-right corner of the display when TDC is assigned to that DDI. TDC assignment is done using the Sensor Control Switch on the stick.

The three primary operating modes of the ATFLIR are standby (STBY), air-to-ground (A/G) and air-to-air (A/A). The FLIR format is also available while the ATFLIR is warming up ("not timed out").

The ATFLIR's sensor suite is mounted on a gimballed platform that can move in two directions. The sensor platform is normally stowed when the power switch is in OFF or STBY, when the landing gear is down, and when the aircraft is stopped on the ground. When airborne and with the ATFLIR active, the sensor platform rotates, exposing the lenses.

The sensor platform is free to rotate in two axes but is limited by obscuration from the aircraft or the rest of the pod structure. This is true of the FLIR and CCD video, the laser target designator, and the laser spot tracker. When the sensors are obscured by a part of the aircraft or the pod itself, the sensors are said to be "masked."

When the laser target designator (LTD) fires, it modulates the laser signal with a pre-coded pulse repetition frequency (PRF). This PRF is coded as a four-digit number, from 1211 to 1688, which is used to distinguish between different simultaneous laser designations made by other aircraft or ground units. Likewise, when the laser spot tracker (LST) searches for a laser, it does so using a specific PRF code, and ignores laser spots with a different code (or unmodulated laser emissions with no code). The code used by the LTD and the one used by the LST need not be the same.

### Sensor Control Panel

Power to the FLIR, laser target designator (LTD), and laser spot tracker (LST) is done using controls on the Sensor Control Panel.

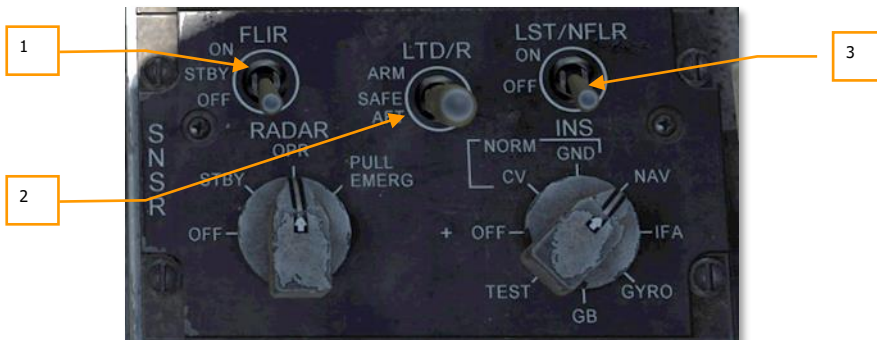

1. **FLIR Power Switch.** In OFF, power to the ATFLIR is removed. In STBY, power is applied to the ATFLIR but no video is displayed. In ON, power is applied, and video is displayed. Moving the power switch from OFF to either STBY or ON begins a warm-up period, during which the FLIR format will display NOT TIMED OUT.
2. **Laser Target Designator Power Switch.** When set to SAFE, the laser target designator will not fire. When set to ARM, the laser target designator will fire when commanded.
3. **Laser Spot Tracker Power Switch.** Controls power to the laser spot tracker.

## ATFLIR Activation

Before the targeting pod can be used, power must be applied. This is done by moving the FLIR Power switch from OFF to either STBY or ON. After doing so, the targeting pod will enter a warm-up period. During this time, the FLIR format will display NOT TIMED OUT:



*Figure 104. ATFLIR format in NOT READY mode.*

Once the warmup period is complete, if the FLIR Power switch is in STBY, the FLIR format will display STBY in the upper-left corner, and show standby symbology:



Figure 105. ATFLIR format in STBY mode.

If the FLIR Power switch is moved to ON, the ATFLIR will begin displaying video. Initially, video will be slaved to the velocity vector (VSVL).



# AIR-TO-GROUND MODE

The ATFLIR is in air-to-ground mode any time the aircraft master mode is A/G.



Figure 106. ATFLIR format in OPR mode (controls).

**Operating Mode.** Displays the current operating mode of the ATFLIR:

- **RDY:** Not timed out (ATFLIR is warming up)
- **STBY:** Standby (ATFLIR is powered but in standby mode)
- **IBIT:** Interruptive BIT (ATFLIR is in TEST mode)
- **OPR:** Operating

**Field of View.** Depressing this PB toggles between WFOV (wide field-of-view), MFOV (medium field-of-view) and NAR (narrow field-of-view). The second line displays the current zoom level within that field of view. Both MFOV and NAR have Z1.0 and Z2.0 levels available, while WFOV only has Z1.0.

**Zoom Level.** The pushbuttons alter the zoom level within the current field of view. The current zoom level is shown adjacent to the word "ZOOM". Both MFOV and NAR have Z1.0 and Z2.0 levels available, while WFOV only has Z1.0.

Field of view and zoom together can also be modified using the antenna elevation control on the throttle when TDC is assigned to the FLIR.

**TV/IR.** Pressing this PB toggles the video display between TV (normal CCD video) and IR (infrared video).

**FOV Azimuth/Elevation.** These fields indicate the ATFLIR field-of-view's angle away from boresight. In the image, the ATFLIR is pointing 1° right of boresight and 12° below boresight.

**Focus.** The pushbuttons alter the focus level of the IR video. The number adjacent the word "FOCUS" is the current focus level. Not implemented.

**Polarity.** Pressing this PB toggles the infrared video between WHT (white-hot) and BLK (black-hot) polarity. Not shown when TV video is active.

**Auto Level & Gain.** Pressing this PB toggles auto level and gain on and off. When on, video level and gain is controlled automatically to produce the best image. When off, level and gain is controlled by the pilot. See Manually Controlling Level and Gain, below.

**Reticle Toggle.** Pressing this PB displays or inhibits the reticle.

**Coordinates.** This datablock displays the coordinates where the current pod FOV intersects with the ground (i.e., the location under the reticle). Coordinates are displayed as latitude and longitude, then elevation, and then MGRS grid. If the offset reticle is displayed, the coordinates will reference the offset reticle.

**VVI Slave.** Boxing VVSLV slaves pod LOS to the VVI in the HUD. VVSLV can also be activated by pressing the Undesignate button twice.

**Setup Page.** Pressing this PB displays additional setup options. The number adjacent the word "SETUP" is the active profile. Currently only profile 01 is available. See SETUP Menu, below.



Figure 107. ATFLIR format in OPR mode (display elements).

**Reticle.** The reticle indicates pod LOS. The shape of the reticle depends on the current tracking mode (see Tracking Modes, below).

**MFOV/NAR Field of View.** In WFOV, the tick marks at the edges of the reticle indicate the MFOV area. In MFOV, the ticks indicate the NAR area. The tick marks are larger in WFOV than they are in MFOV, to indicate the current zoom level. The tick marks are not displayed in NAR.

**North Arrow.** Indicates the direction of magnetic north. Rendered as four tick marks oriented along the ground plane.

**Velocity Vector and Horizon Line.** Repeats the velocity vector and horizon line on the HUD. The horizon line flashes if the aircraft enters an unusual attitude.

**Current Steerpoint.** Indicates the location (including elevation) and number of the active steerpoint.

**Situational Awareness Cue.** This diamond moves left or right from center to indicate that the pod has a left or right azimuth offset from boresight. The diamond moves up or down to indicate that the pod has an up or down elevation offset from boresight. When boresighted, the diamond is centered laterally and close to the top of the display. The extreme edges of the display roughly correspond to the slew limits of the pod. The diamond is centered vertically on the screen when the pod is pointed straight down.

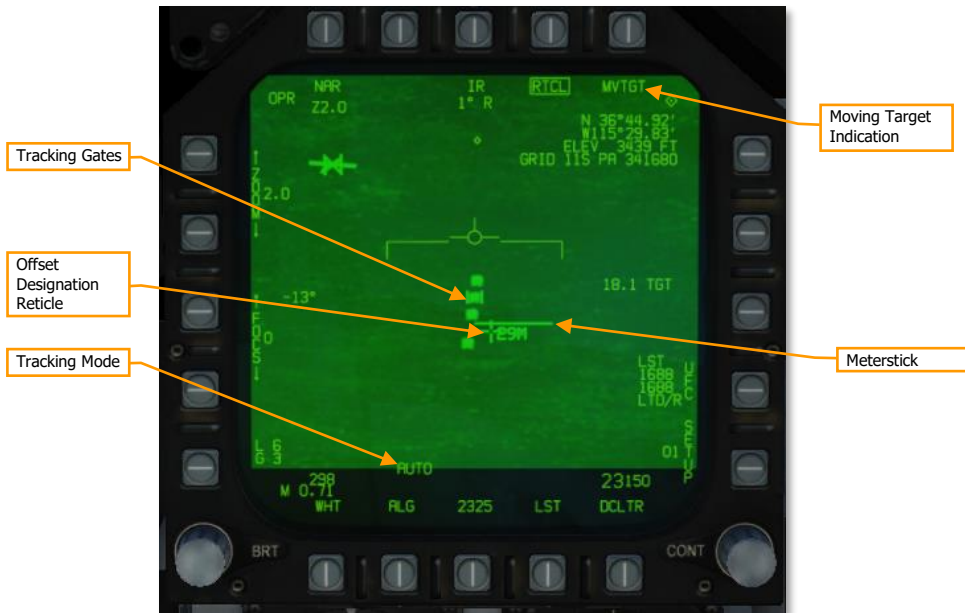

Figure 108. ATFLIR format in OPR mode (tracking elements).

**Tracking Mode.** Indicates the current target tracking mode. See Tracking Modes, below. Pressing the SCS in the direction of the FLIR format cycles between designation, SCENE, and AUTO tracking modes. Pressing the Undesignate button activates INR tracking mode.

**Tracking Gates.** In AUTO track mode, the reticle becomes a pair of tracking gates. The gates expand or contract to enclose the target that was contrast-locked and is being tracked.

**Offset Designation Reticle.** This reticle is used to make an offset designation (see Offset Designation, below).

**Meterstick.** The meterstick is rendered as a horizontal line. The number below the meterstick is the length of that line in meters along the ground plane.

**Moving Target Indication.** "MVTGT" is displayed when tracking a moving target. This field is blank when not tracking a moving target.

## Tracking Modes

The ATFLIR is in one of the following tracking modes at any time:

- **INR.** This mode is active when the pod is being slewed. It maintains pod orientation relative to the aircraft by using inertial rate data from the aircraft.
- **SCENE.** The ATFLIR attempts to track the portion of the image under the reticle. This tracking mode is effective against stationary targets without well-defined edges.
- **INR SCENE.** The ATFLIR enters this mode when the pod is slewed while in SCENE mode. The ATFLIR will enter SCENE mode again once slewing is complete.
- **AUTO.** The ATFLIR attempts to track an object centroid using a contrast-detecting algorithm. This tracking mode is effective against stationary and moving targets with well-defined edges, either in TV or IR mode.
- **INR AUTO.** The ATFLIR enters this mode when the pod is acquiring a target while in AUTO mode. The ATFLIR will enter AUTO mode once acquisition is complete.
- **Designation.** Pod LOS is slaved to the designated target or target waypoint.

Initially the ATFLIR will be in designation mode or will be slaved to the VVI if there is no designation. Pressing the SCS in the direction of the FLIR format will cycle between designation, SCENE, and AUTO modes. Pressing the Undesignate button once will return to INR mode, and pressing it twice will slave the pod to the VVI.

In INR and SCENE modes, the pod can be slewed using the TDC. In designation mode, pressing down on the TDC will activate slew and allow the designation to moved. The TDC cannot be moved in AUTO mode, whether or not the pod is tracking a target.

The reticle shape changes depending on the current tracking mode:



INR tracking mode



SCENE tracking mode while attempting to acquire a lock



SCENE tracking mode with target lock

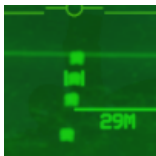

AUTO tracking mode with target lock

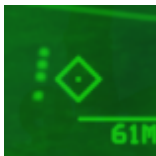

Designation mode

### Using the LTD/R and LST

The FLIR format has options and indications relevant to laser designation and laser search:



Figure 109. ATFLIR LTD/R and LST controls.

**Laser Arm.** This field is displayed whenever the LTD/R switch is in ARM.

**Time to Release.** Displays the estimated time until reaching the weapon release point, in seconds. Post-release, the "REL" text will change to "LASER" and the field will count down until the time the laser begins firing (for LGB attacks). Finally, the text will change to "TTI" and the field will count down the estimated time until impact.

**Distance to Target.** The range to the tracked target, in nautical miles. Displayed when the ATFLIR is in a track mode and the LTD/R is armed.

**Hot Trigger.** Boxing this option will cause the laser to fire whenever the trigger is pressed. When the trigger is pressed, the laser will fire for two seconds. When the trigger is held down, the laser will fire continuously.

**Laser Spot Tracker.** Pressing this PB activates the laser spot tracker. See Using Laser Spot Tracking, below.

**Laser Codes.** Pressing this PB displays options for setting the LTD/R and LST laser codes on the UFC (see Setting Laser Codes, below). The datablock indicates the selected laser codes for the laser spot tracker and the laser target designator/ranger.

## SETUP Menu

Pressing PB 15 (SETUP) will display the setup menu:

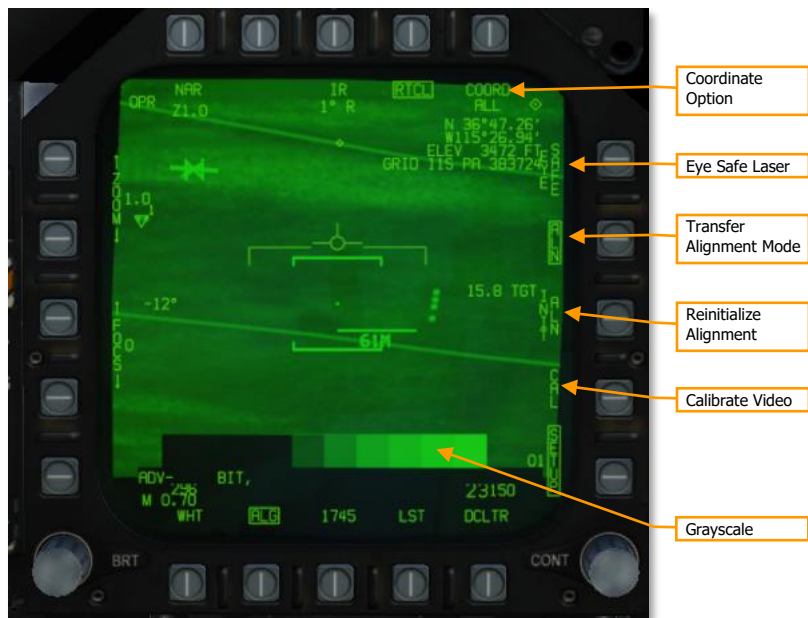

Figure 110. ATFLIR SETUP menu.

**Coordinate Option.** Pressing this PB cycles between the display options for the coordinates datablock: ALL (latitude/longitude, elevation, and MGRS), L/L (latitude/longitude and elevation), GRID (elevation and MGRS) and OFF.

**Eye Safe Laser.** Boxing this option sets the LTD/R laser power to an eye-safe level suitable for training. Not implemented.

**Transfer Alignment Mode.** When boxed, the primary transfer alignment mode (transfers aircraft position and velocity) is used. When unboxed, the reversionary transfer alignment mode (transfers aircraft position only) is used. Not implemented.

**Reinitialize Alignment.** Restarts the transfer alignment process. Not implemented.

**Grayscale.** A static grayscale image. Can be used when manually setting level and gain.

## Setting Laser Codes

To set the laser codes for the LTD/R or the LST, press PB 14, labeled "UFC":



Then, on the UFC, press the OSB adjacent to either LTDC (to set the LTD/R code) or LSTC (to set the LST code):



Finally, enter the laser code and press ENT. The new code will be reflected on the FLIR format.

## Designating and Tracking Ground Targets

The ATFLIR will initially be slewed to the designated target, if one has been designated. For example, if you have a waypoint in the vicinity of the target area, or an A/G radar lock in the target area, designating that waypoint or radar lock will cause the ATFLIR to slew to that location. From there, you can assign TDC to the FLIR format, and press down on the TDC to activate slewing. Use the TDC to locate the target and move the designation to it.

Designate mode is an inertial-rates tracking mode, which means the pod is using the aircraft's inertial data only to track the target, which will incur inaccuracies over time. With the TDC assigned to the FLIR format, press the SCS in the direction of the FLIR format to change to SCENE tracking mode. SCENE mode is suitable for tracking stationary targets.

If you wish to track a moving target, position the reticle just ahead of the moving target and then press the SCS once more to change to AUTO mode. As the vehicle moves into the reticle, the pod will lock onto it and begin tracking it. If the pod was unable to acquire the target, cycle back to INR or SCENE mode, reposition the reticle, and change back to AUTO mode for another attempt.

Once a target has been acquired by the pod, the designation can be used for attacks with laser-guided bombs. See Laser-Guided Bombing for more.

Pressing the Undesignate button will return the pod to INR mode.

### Offset Designation

When in AUTO mode with a target acquired, pressing the TDC will show the Offset Designation reticle:



Figure 111. Offset Designation Reticle

When the Offset Designation reticle is displayed, the coordinates in the top-right datablock reference that reticle instead of the tracked target. You can slew the Offset Designation reticle using the TDC. The Offset Designation reticle always moves relative to the tracked target; it is not ground-stabilized.



## Designating Targets Using the Laser

The laser target designator/rangefinder (LTD/R) is a pulsed laser that is automatically aimed along pod line of sight. In the designation role, the laser can provide a guidance solution for laser-guided munitions, both onboard the designating aircraft and from other units; and it can train other platforms' sensors onto the designated target. In the range-finding role, the laser provides continuous target slant range measurements to the aircraft avionics.

To use the LTD/R, the LTD/R switch on the Sensor Control Panel must be set to ARM. Normally, the laser will fire automatically when designating a target, launching an AGM-65E, or dropping an LGB. Boxing the TRIG option (PB 11) allows the laser to be controlled by the trigger. This is useful when buddy-lasing (designating a target for another aircraft to fire upon).

## Using Laser Spot Tracking

The ATFLIR can also detect and track laser signals emitted by other aircraft or ground units, in laser spot track (LST) mode. In this mode, the targeting pod searches for a laser signal by its PRF code. When the laser signal is detected, the pod slews to the target being designated by that laser. Laser spot tracking can be by other aircraft or ground units to slew your targeting pod onto their target.

To set the PRF code that the laser spot tracker searches for, press PB 14 (UFC) on the FLIR format. Box PB 17 (labeled LST) to activate LST mode. The display will initially blank:

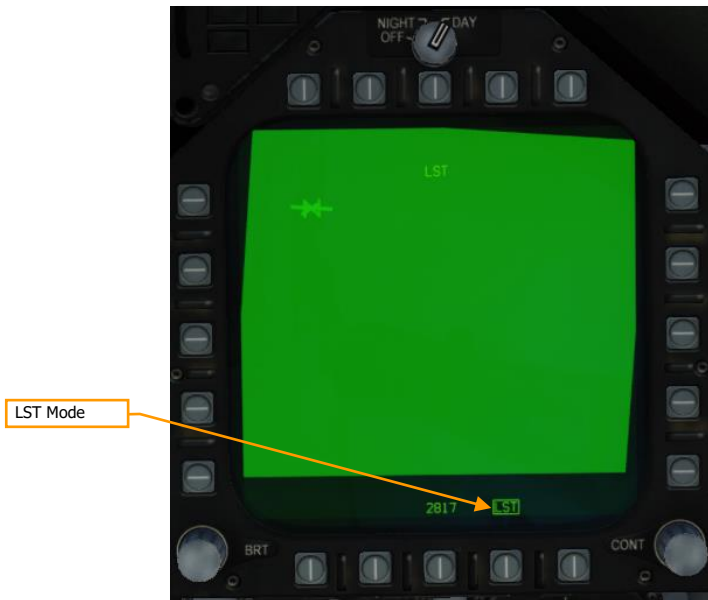

Figure 112. LST Display Prior to Laser Detection



*Figure 113. LST Display After Laser Detection*

Once a designation laser is detected, the pod will slew to its location, and “LST” will be displayed at the top of the FLIR format. You can then designate the target or switch to a tracking mode, and LST mode will automatically exit.

## Manually Controlling Level and Gain

Normally the video level (brightness) and gain (contrast) is controlled automatically to produce the best picture. If needed, the pilot can manually adjust level and gain to identify targets that would otherwise appear washed out or too dark.

To manually control level and gain, unbox the ALG option at PB 19. After doing so, the ZOOM and FOCUS controls will be replaced by level and gain controls:

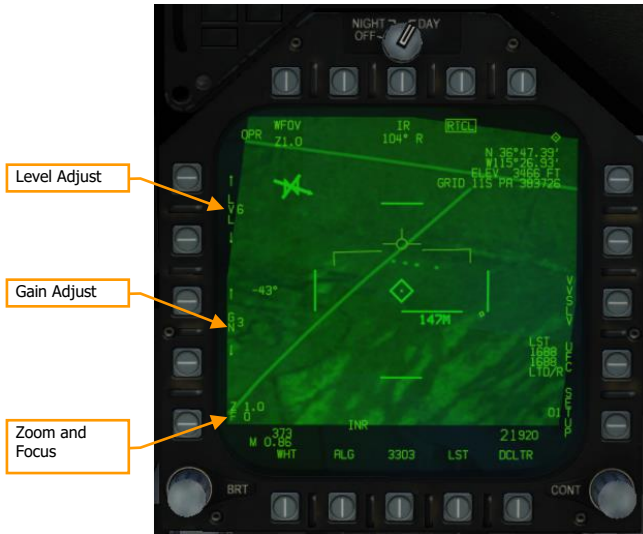

*Figure 114. Manual Level and Gain Controls*

Use PB 2 through 5 to manually adjust level and gain. Zoom and focus levels are shown adjacent to PB 1. Pressing PB 1 restores the zoom and focus controls, and gain and level values will then be displayed adjacent to PB 1.

Pressing PB 19 returns the ATFLIR to auto gain and level.

## AIR-TO-AIR MODE

The ATFLIR is in air-to-air mode whenever the aircraft master mode is A/A. Most of the controls and symbology are shared with the air-to-ground mode:

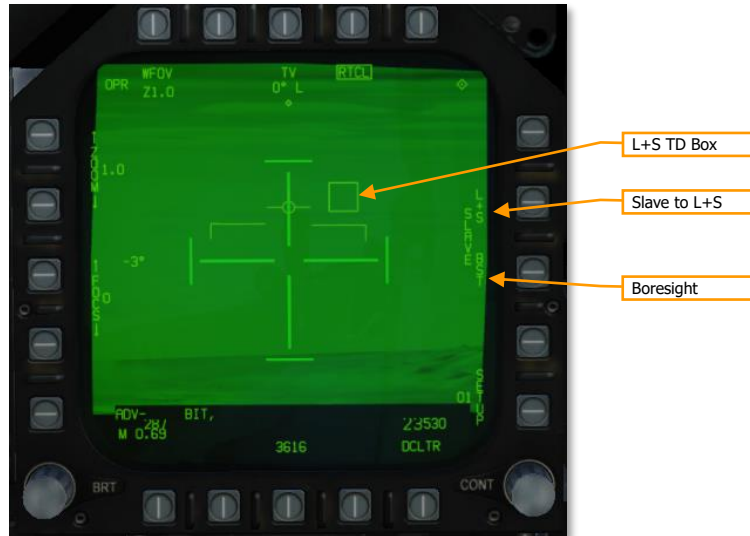

Figure 115. ATFLIR Air-to-Air Mode

**L+S TD Box.** This box encloses the Launch & Steering Target. The L+S is outside pod FOV, the box flashes and is pinned to one side of the display.

**Slave to L+S.** Pressing this PB slews the pod to the current L&S. The pod remains slewed to the L&S while this PB is boxed. Pressing the PB again will return the pod to INR mode and allow slewing.

**Boresight.** Pressing this PB boresights the pod. Slewing the pod will automatically unbox this PB.

### Acquiring Air Targets

In air-to-air mode, only INR and AUTO tracking modes are available. Either boresight the pod or slave it to the L&S to put the target within the pod FOV. Once the target is within the pod FOV, press the SCS switch in the direction of the FLIR format to command AUTO track. The pod will attempt to lock onto the aircraft. It is not necessary to place the reticle over the aircraft first.



Figure 116. ATFLIR Air-to-Air mode, post-designate

# LITENING II TARGETING POD



## AN/AAQ-28 LITENING II

The Litening II Targeting Pod is a combination TV video and infrared video sensor platform. It provides the pilot with a live image from either the CCD (which senses light in the visible range) or the forward-looking infrared (FLIR). The targeting pod is also capable of tracking moving targets, cueing the designator laser, and searching for other laser designations.

The targeting pod can be selected to either the left or right DDIs, but not the central MPCD. It is selected from the PB6 on the TAC page with the Master Mode set to A/G or NAV.

The targeting pod camera is slewed using the TDC, when the TDC is assigned to the DDI displaying the FLIR format. As with other formats, a small diamond appears in the top-right corner of the display when TDC is assigned to that DDI. TDC assignment is done using the Sensor Control Switch on the stick.

The three primary operating modes of the targeting pod are standby (STBY), air-to-ground (A/G) and air-to-air (A/A). The FLIR format also displays when the FLIR is off, or when it is warming up ("not timed out").

The targeting pod's sensor suite is mounted on a gimballed platform that can move in two directions. The sensor platform is normally stowed when the power switch is in OFF or STBY, when the landing gear is down, and when the aircraft is stopped on the ground. When airborne and with the targeting pod active, the sensor platform rotates, exposing the lenses.

The sensor platform is free to rotate in two axes but is limited by obscuration from the aircraft or the rest of the targeting pod structure. This is true of the FLIR and CCD video, the laser target designator, and the laser spot tracker. When the sensors are obscured by a part of the aircraft or the pod itself, the sensors are said to be "masked."

When the laser target designator (LTD) fires, it modulates the laser signal with a pre-coded pulse repetition frequency (PRF). This PRF is coded as a four-digit number, from 1211 to 1688, which is used to distinguish between different simultaneous laser designations made by other aircraft or ground units. Likewise, when the laser spot tracker (LST) searches for a laser, it does so using a specific PRF code, and ignores laser spots with a different code (or unmodulated laser emissions with no code). The code used by the LTD and the one used by the LST need not be the same.

## Targeting Pod Activation

Before the targeting pod can be used, power must be applied. This is done by moving the FLIR Power switch from OFF to either STBY or ON. After doing so, the targeting pod will enter a warm-up period. During this time, the FLIR format will display NOT TIMED OUT:



Once the warmup period is complete, if the FLIR Power switch is in STBY, the FLIR format will display STBY in the upper-left corner, and show standby symbology:





When the FLIR Power switch is in ON, OPR (operating) will display in the upper-left corner of the FLIR format, but no video will be displayed initially:



To activate video, you must first designate an aimpoint for the targeting pod. In NAV or A/G master modes, this can be done by designating a sensor point of interest (SPI). For example, you might use the WPDSG pushbutton on the HSI to designate a target waypoint, or you might acquire an A/G radar lock. When a SPI is designated, the targeting pod will drive its LOS to that location and begin transmitting video.

# AIR-TO-GROUND (A/G) MODE

The FLIR is in air-to-ground mode any time the aircraft Master Mode is set A/G.

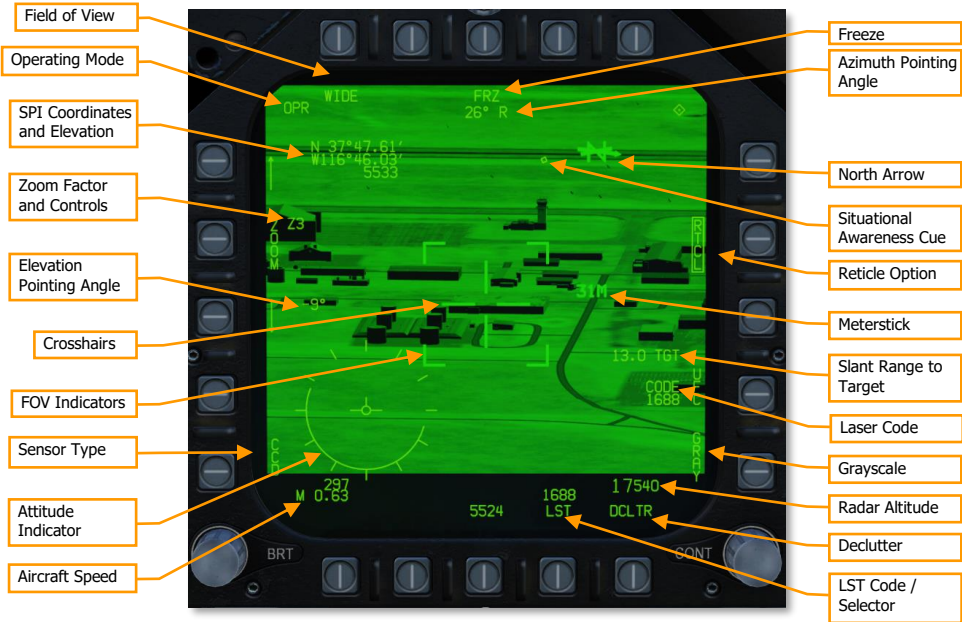

Figure 117. FLIR Format in CCD Mode

**Operating Mode.** Line 1 displays STBY if the pod is in standby, and OPR if it is powered on and operating. Line 2 is blank when the pod is in SCENE mode, or it displays ATRK when the pod is in area track mode, or PTRK when in point track.

**Field of View.** Depressing this OSB toggles between Narrow Field of View (NFOV) or Wide Field of View (WFOV). These views can vary between the CCD and FLIR sensors in the TGP. Field of view can also be toggled using the FLIR FOV button on the throttle.

- FLIR field of view selections:
  - WFOV: 4° × 4°
  - NFOV: 1° × 1°
- CCD field of view selections:
  - WFOV: 3.5° × 3.5°
  - NFOV: 1° × 1°

**Sensor Type.** Sets current video mode, either FLIR (forward-looking infrared) or CCD (charge-couple device, TV video).

**Target Coordinates/Elevation.** The lat/lon coordinates and elevation in feet of the current target. This is usually the point in the center of the crosshairs at ground level.

**Zoom Factor and Controls.** Within an FOV selection, you may further adjust zoom factor using the pushbutton arrows. The zoom range is Z0 (no zoom) to Z9 (highest level of zoom within FOV). Z9 represents double the zoom level of Z0. You can also control zoom level using the radar elevation control on the throttles.

**Elevation Pointing Angle.** Indicates the current vertical angle away from boresight of TGP LOS.

**Crosshairs.** Indicates sensor line of sight. Sensor line of sight is used when designating targets and firing the laser designator.

**Field of View (FOV) Indicators.** These four corner brackets are only shown when WIDE FOV is enabled and indicate the portion of the image that will be displayed if NARO FOV is enabled.

**Freeze.** Freezes video when boxed. Symbology continues to change, representing current conditions, but the image is frozen. Zoom changes and field of view changes are disabled while FRZ is boxed.

**Azimuth Pointing Angle.** Indicates the current horizontal angle away from boresight of TGP LOS.

**North Arrow.** The arrowhead indicates the direction of north along the ground in the image. Additional lines represent east, south, and west.

**Situational Awareness Cue.** The SA cue is a visual indication of LOS. Movement up and down the display indicates longitudinal (forward and back) movement of the targeting pod LOS, and movement across the display indicates lateral (left and right) movement of the targeting pod LOS. When the SA cue is at the center of the display, the pod is pointing straight down.

**Reticle Option.** When boxed, the crosshairs and narrow FOV brackets are displayed in WFOV mode, and the crosshairs are displayed in NFOV mode.

**Meterstick.** This indicates the length along the ground, in meters, spanned by one of the horizontal crosshair lines. In the above image, the building directly under the crosshairs is well over 60 meters wide.

**Slant Range to Target.** The direct line-of-sight range from the targeting pod to the object under the crosshairs, in nautical miles.

**Laser Code.** Displays the current laser code, which will be used by the LTD when the laser designator is fired. The code can be changed by pressing the adjacent pushbutton, labeled UFC. See Designating Targets Using the Laser, below.

**Grayscale.** When boxed, displays a ten-stage grayscale indication, for brightness calibration.

**Attitude Indicator.** Visual representation of the aircraft's current attitude. The solid portion of the circle represents the part of an analog attitude indicator that is below the horizon. Removed when declutter (DCLT) is active.

**Radar Altitude.** Current radar altitude above ground level.

**Aircraft Speed.** Displays current aircraft speed in KCAS and Mach.

**Declutter.** Hides the airplane Mach and velocity indicators, attitude indicator, azimuth steering line, and sensor field of regard.

**LST Code.** Indicates the laser PRF code that will be searched by the laser spot tracker. Pressing this pushbutton commands the pod to enter LST mode. (See Using Laser Spot Tracking, below.)

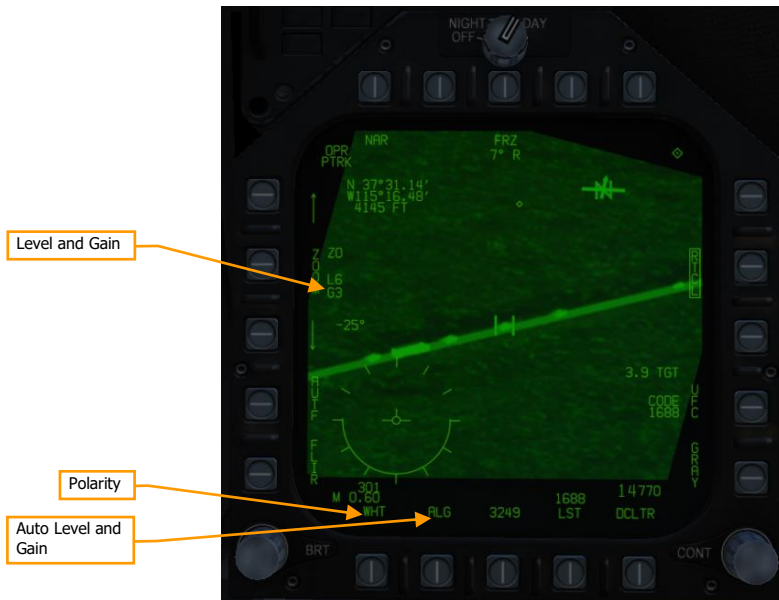

Figure 118. FLIR Format in FLIR Mode

**Auto Level and Gain.** Boxing ALG commands the image processor to automatically control level and gain for best image clarity. Unboxing ALG reveals the manual level and gain controls.

**Level and Gain.** Shows the current image level (brightness) and image gain (contrast) from the FLIR. Pressing PB4 (labeled ZOOM) cycles between manual control of ZOOM, LVL (level), and GAIN. Only shown when ALG is not boxed.

**Polarity.** Cycles between WHT (white hot) and BHT (black hot) image polarity.

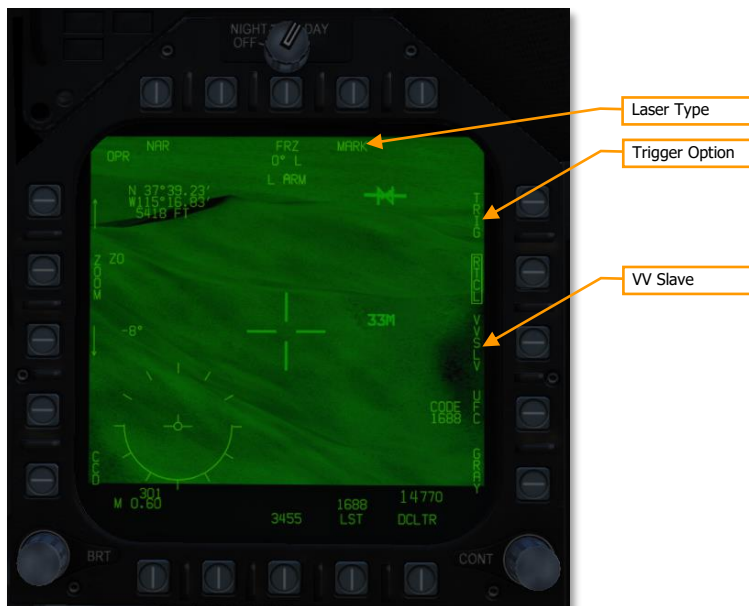

Figure 119. FLIR Format With LTD/R Armed

**Laser Type.** Pressing this pushbutton cycles between laser types: MARK (target designation laser), PTR (infrared pointer, used to visually point out targets at night), and BOTH.

**Trigger Option.** When boxed, pressing the trigger fires the laser for two seconds, and pressing and holding the trigger fires the laser while the trigger is held. When unboxed, the laser automatically fires:

- when a designation is made, for ranging purposes
- for AGM-65E launches, from when the Maverick is uncaged until 10 seconds after predicted impact
- for laser guided bombs, from 15 seconds prior to predicted impact until 10 seconds after predicted impact

**VV Slave.** When boxed, slaves the pod LOS to the total velocity vector (TVV) shown on the HUD. Does not change the SPI.

## Locating and Tracking Surface Targets

Once targeting pod video is available, the targeting pod LOS initially follows the SPI. When the pod is in SCENE mode, you can use the TDC to slew targeting pod LOS away from the SPI, to search the surrounding area for targets. By switching between FLIR and CCD modes using PB1, you can make concealed or camouflaged targets more visible due to their obvious heat signature against the background. Use of FLIR mode is also necessary to get usable video at night or low-light situations.

Pressing the sensor control switch right cycles between SCENE, ATRK, and PTRK track modes. ATRK is used to track stationary vehicles and structures.

PTRK is used when designating moving vehicles. The pod will attempt to maintain a track on the centroid of the object under the crosshairs. The pod will only be able to maintain track if the object under the crosshairs stands out from its background. If the tracked object becomes concealed, masked, or indistinguishable from the background, the pod will enter inertial mode. In inertial mode, the pod will continue slewing according to the last known direction and speed of the track target. If the target reappears in the vicinity of pod LOS, the pod will automatically re-acquire track.

In PTRK mode, if the target centroid merges with a different moving vehicle, the pod may mistakenly switch track to the other vehicle. When this happens, you will have to return to SCENE mode, place the cursor over the original target, and return to PTRK mode.

In ATRK and PTRK modes, pressing the TDC shows the offset cursor. The offset cursor can be moved away from the track target. The upper-left datablock, showing coordinates and altitude, will follow the offset cursor instead of the track target.

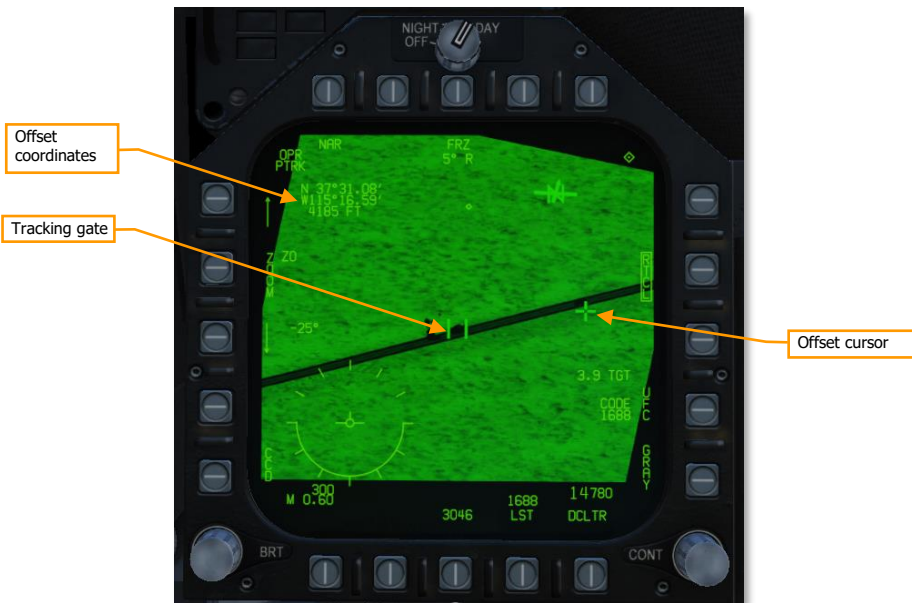

Figure 120. PTRK Mode with Offset Cursor

## Designating Targets Using the Laser

The laser target designator/rangefinder (LTD/R) is a pulsed laser that is automatically aimed along pod line of sight. In the designation role, the laser can provide a guidance solution for laser-guided munitions, both onboard the designating aircraft and from other units; and it can train other platforms' sensors onto the designated target. In the range-finding role, the laser provides continuous target slant range measurements to the aircraft avionics.

To use the LTD/R, the LTD/R switch on the Sensor Control Panel must be set to ARM. When the LTD/R switch is in ARM, PB9 cycles between laser emitters. When set to MARK, the laser designator will fire. This laser is invisible to the eye and provides a firing solution for laser-guided munitions like the GBU-12 and AGM-65E. Normally, the laser will fire automatically when designating a target, launching an AGM-65E, or dropping an LGB. Boxing the

TRIG option (PB11) allows the laser to be controlled by the trigger. This is useful when buddy-lasing, designating a target for another aircraft to fire upon.

When the emitter is set to PTR, the LTD/R fires an eye-safe infrared pointer. This pointer is visible at night when wearing night-vision goggles and is used to visually point out targets. It is not capable of providing a firing solution to laser-guided munitions.

## Using Laser Spot Tracking

The Litening pod can also detect and track laser signals emitted by other aircraft or ground units, in laser spot track (LST) mode. In this mode, the targeting pod searches for a laser signal by a specific PRF code. When the laser signal is detected, the pod LOS slews to the target being designated by that laser. Laser spot tracking can be used by other aircraft or ground units to slew your targeting pod onto their target.

To set the PRF code that the laser spot tracker searches for, press PB14 (UFC) on the FLIR format.

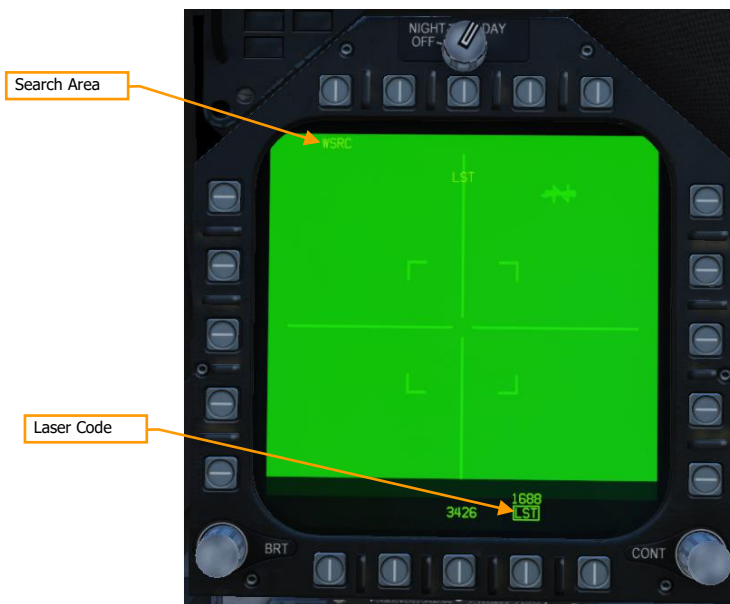
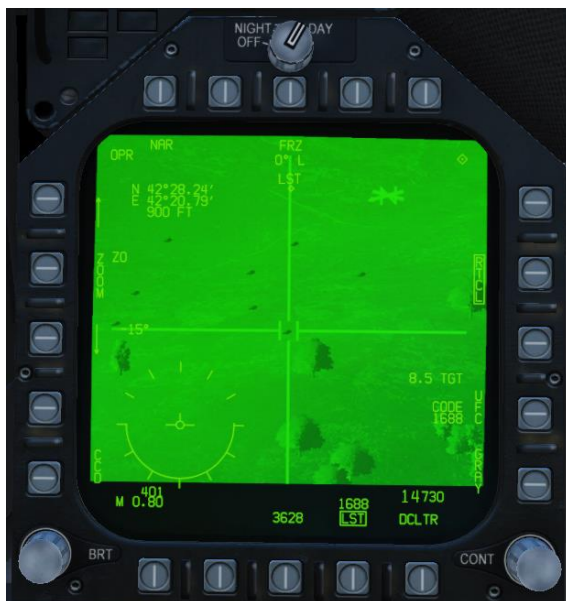

Figure 121. LST Display Prior to Laser Detection

Pressing PB17 (labeled LST) commands the targeting pod into laser spot track mode. Initially, the display will be blank and "LST" will flash in the MPCD and HUD. The pod will search for a laser designation near its LOS, so it's important to have the pod looking in the expected area of the target when using LST.

**Search Area.** Toggles between WSRC (wide search) and NSRC (narrow search). Controls the size of the search area the pod scans.

**Laser Code.** The PRF code that the LST is searching for. "LST" is boxed when LST mode is active.



*Figure 122. LST Display After Laser Detection*

Once a designation laser is detected, pod LOS will slew to its location, and "LST" will stop flashing in the MPCD and HUD. You can then unbox LST with PB17 to initiate your own target track with the pod.



## AIR TO AIR (AA) PAGE

When the air-to-air master mode is selected, the targeting pod will be in air-to-air mode. This mode can be used to acquire, track, and monitor airborne targets, designated using either the radar or visually using the pod itself.

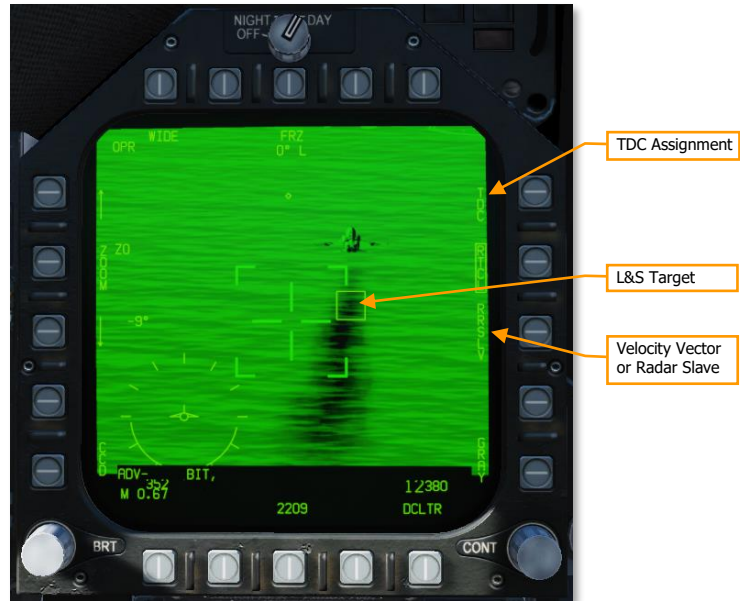

Figure 123. FLIR Format in Air-to-Air Mode

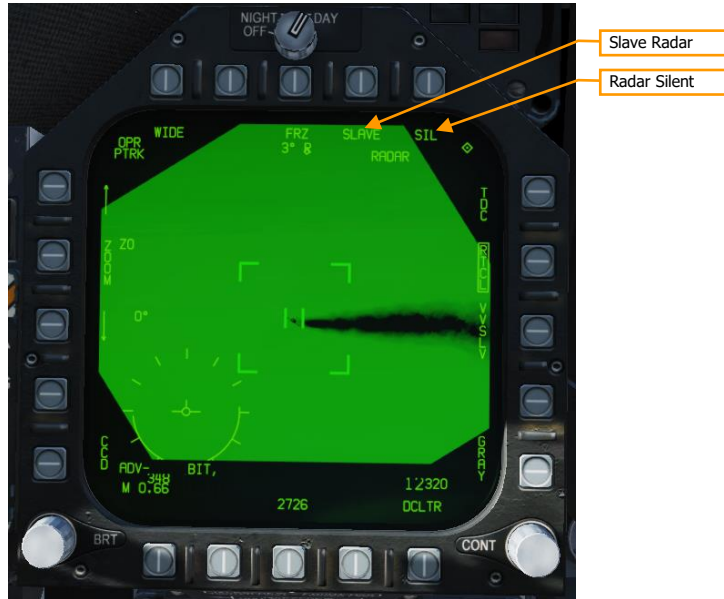

Figure 124. FLIR Air-to-Air Format (Tracking)

**TDC Assignment.** If the other MPCD is showing the Attack Radar format, this pushbutton toggles the TDC between the radar and FLIR formats.

**Velocity Vector Slave (VVSLV).** Commands the FLIR LOS to the TVV. This option is only available when the radar is in search mode, and when the pod is stowed, in auto-track mode, or in inertial LOS mode.

**Radar Slave (RRSLV).** Commands the FLIR LOS to the radar target designation. This option is only available when the radar is in track mode.

**Slave Radar.** Commands the radar to scan and track any target along pod LOS, effectively "handing off" the pod track to the radar. Only available when the pod is in PTRK mode.

**Radar Silent.** Inhibits radar emissions when boxed. Because the FLIR is a non-emitting target tracking system, inhibiting the radar can prevent the target from becoming aware that they are being tracked.

## Tracking Aircraft

When initially in air-to-air mode, the targeting pod LOS will be slaved to the total velocity vector (TVV) in the HUD. You can either locate and designate targets visually, using the pod itself, or by slaving it to the radar.

### *Tracking Aircraft Using the Litening II Pod*

When the pod LOS is slaved to the TVV, you can visually acquire aircraft in the FLIR FOV by placing the TVV over the aircraft. When TDC priority is on the FLIR format, pressing Castle Switch in the direction of the MPCD displaying the FLIR format attempts a point track on a target within FLIR FOV. If point track is successful, the operating mode will change to PTRK, and tracking gates will show on either side of the track target (see Figure 124. FLIR Air-to-Air Format (Tracking)).

If the FLIR is tracking the wrong target, or you wish to cease tracking, pressing the VVSLV pushbutton will return pod LOS to the TVV. While the FLIR is tracking, pressing Castle Switch in the direction of the MPCD displaying the FLIR format again will cycle between point and area track.

Once the FLIR has a track target, pressing PB9 (SLAVE) will attempt a radar lock at the target along FLIR LOS.

### *Tracking Aircraft Using the Radar*

When the pod is not tracking its own target (e.g., slaved to the TVV), and the radar is in a track mode (e.g., TWS or STT), pod LOS will automatically follow the L&S target. Once you have a radar track, you can switch TDC priority to the FLIR format, and then press the Castle Switch in the direction of the FLIR format again to command point track. This will momentarily freeze pod LOS, so it's recommended to wait until target LOS rate is small first. If point track is successful, the operating mode will change to PTRK, and tracking gates will show on either side of the track target (see Figure 124. FLIR Air-to-Air Format (Tracking)).

Once point track is successful, you can then move TDC priority back to the radar format and change L&S targets. The pod will continue tracking its own target until you select VVSLV or press the pinky button to command to cage the targeting pod.

# JOINT HELMET-MOUNTED CUEING SYSTEM



# HELMET MOUNTED DISPLAY (HMD)

The Joint Helmet Mounted Cueing System (JHMCS) is a bolt-on kit to the flight helmet that always allows the pilot to view aircraft and weapon information. It also allows the slaving of sensors and weapons to the helmet's line of sight. This is a particularly effective system when paired with the AIM-9X high off-boresight dogfight missile. The helmet can slave weapons and sensor up to 80° off boresight.

## HMD Power

Power to the HMD is selected from the HMD control knob on the right instrument panel. Rotating the knob clockwise from the OFF position to BRT (brightness) provides power to the HMD. Continued clockwise rotation increases HMD brightness.

## HMD Built-In Tests

The JHMCS built-in test suite is activated from the DISPLAYS BIT. To access these BITs, navigate to the SUPT menu, then press BIT (PB 8), then DISPLAYS (PB 11), then HMD (PB 11).

Once the HMD BIT is started, IN TEST is displayed for the HMD BIT status indication. This and the four test patterns will be displayed until the BIT STOP pushbutton (PB 10) is pressed.

- If STOP is pressed before all patterns are displayed, RESTRT will be displayed.
- If STOP is pressed after all patterns are displayed, GO will be displayed.

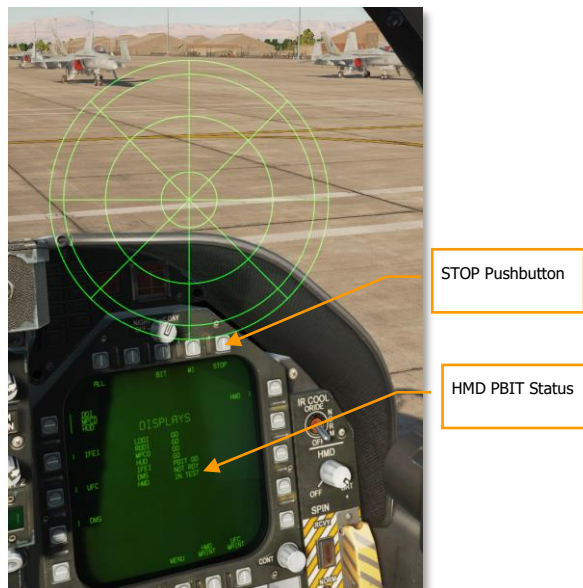

Figure 125. HMD Built in Test (BIT)

## HMD Alignment

To use the HMD, it must be aligned prior to takeoff. HMD alignment is completed for you if the mission begins with your aircraft already started, but for cold-start missions, you must complete the HMD alignment yourself. To align the HMD, do the following:

1. Power on the HMD by rotating the HMD knob out of "OFF".
2. Start the built-in test as described in HMD Built-In Tests, above.
3. Wait until all four test patterns have been displayed, then press "STOP" (PB 10). Verify "PBIT GO" is shown on the MFD.



4. From the SUPT menu, navigate to HMD (PB 3), then ALIGN (PB 20). The coarse alignment cross will be displayed on the HUD and HMD.

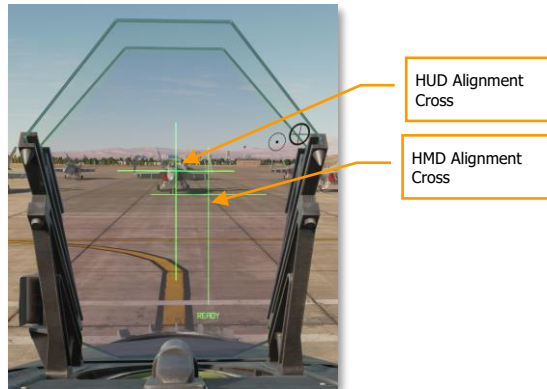

5. Move your head to align the two crosses.
6. While holding your head steady, press and hold the CAGE/UNCAGE button on the throttle. "ALIGNING" will display on the HUD for about 2.5 seconds. After alignment is complete, the HUD will display "ALIGN OK", and you can release the CAGE/UNCAGE button.

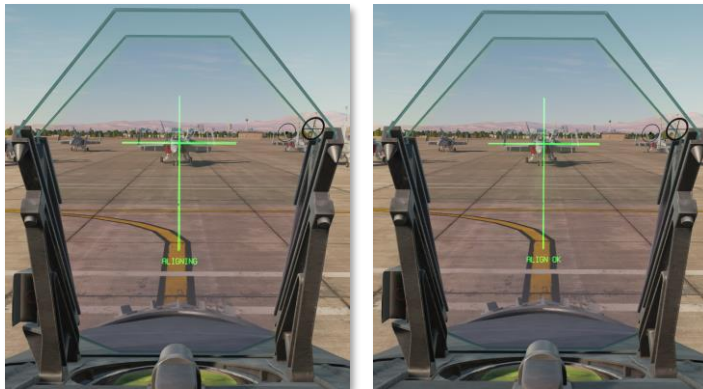

7. The DX/DY and DROLL crosses will be displayed in the HMD, and "FA DX/DY" (fine alignment) will be displayed in the HUD below the alignment cross. Use the TDC to align the DX/DY cross with the HUD alignment cross, then press and release the TDC.

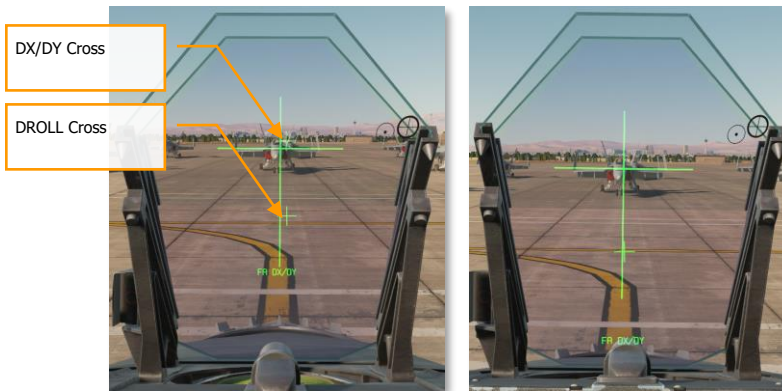

8. The text in the HUD will change to "FA DROLL." Use the TDC to rotate the DROLL cross until it's aligned with the bottom portion of the HUD alignment cross.

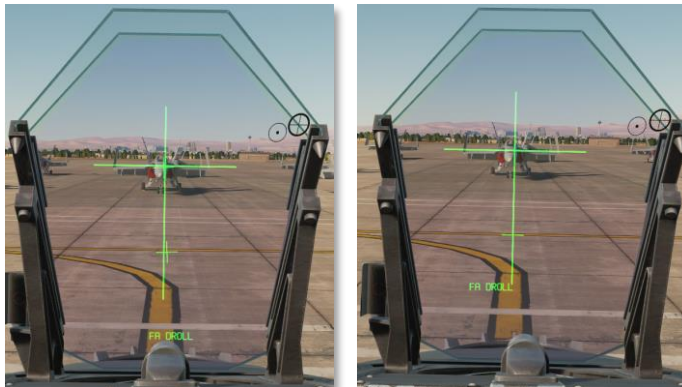

9. Once alignment is satisfactory, exit alignment mode by moving TDC priority to another display, exiting the HMD menu, or changing master mode. You can also restart the alignment procedure if desired by exiting and re-entering HMD alignment mode.

After aligning, you can turn off the HMD using the Power knob if desired.

**Note:** If you look too far away from the HUD during the alignment process, the HUD will display the text "CENTER DISPLAY". If this happens, you must restart the alignment procedure by exiting and re-entering HMD alignment mode.



## HMD Format DDI Page

On the Support (SUPT) the HMD legend is located at pushbutton 13. Upon selection, the HMD Format Page is displayed with the following functions:

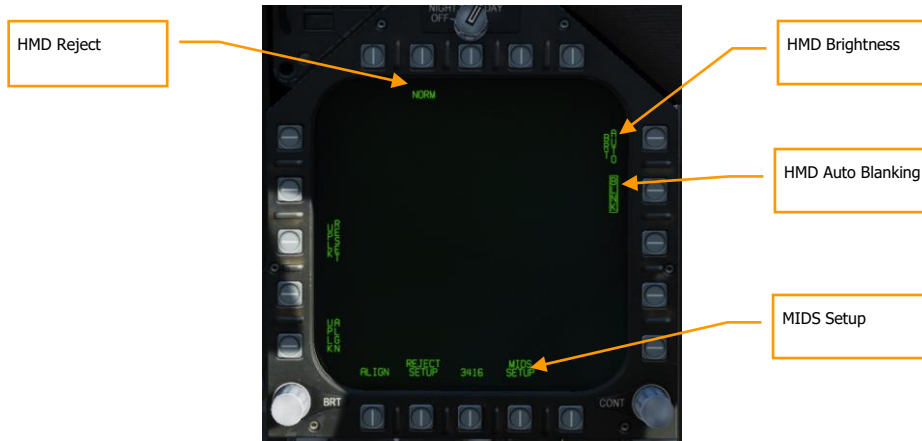

Figure 126. HMD SUPT Page

**BRT (Brightness) Control.** Pushbutton 11 controls the brightness of HMD (in conjunction with the HMD knob). Successive presses of this pushbutton cycle through DAY, NIGHT, and AUTO.

- DAY. Full brightness
- NIGHT: ½ brightness
- AUTO: Automatic adjustment of brightness for best visibility

**HMD REJECT.** As with the HUD, the pilot can declutter the HMD display with successive presses of pushbutton 7. They cycle through NORM, REJ 1, and REJ 2. The selected reject option is displayed as the legend below pushbutton 7.

With the switch placed to NORM, the normal amount of symbology is provided for all HUD displays. Placing the switch to REJ 1 removes aircraft Mach number, aircraft g, bank angle and pointer, airspeed box, altitude box, peak positive g, and required ground speed cue from the HUD. Placing the switch to REJ 2 removes all REJ 1 symbology plus the heading scale, current heading indication (caret/T), command heading marker, NAV/TACAN range, and the ET / CD timer.

The reject settings can further be modified with the Reject Setup sub-level.

**HMD AUTOMATIC BLANKING.** When enabled, automatic blanking is enabled. This is done by boxing the BLNK at pushbutton 12.

To avoid duplication of HMD symbology when the player is also looking through the HUD, much of the HMD symbology is removed in such a circumstance. This is termed automatic blanking.

- When in **air-to-air master mode**, only the following is displayed:
  - AIM-9 seeker reticle
  - Radar boresight circle
  - Aiming cross

- HMD line of sight elevation
- Target designation box
- Locator line

This will result in some “ghosting” of duplicate symbology. This can be removed with manual blanking.

- When in **air-to-ground mode**, all HMD symbology is removed except the aiming cross and HMD line of sight elevation.
- When in **navigation mode**, only the HMD aiming cross is still displayed.

Additionally, HMD manual blanking can be toggled by pressing the RECCE button on the control stick. When enabled, all HMD symbology is hidden.

**REJECT SETUP.** From pushbutton 19, the pilot can further filter the information displayed based on the reject level selected. Up and down arrows at pushbuttons 4 and 5 allow the selection of HMD elements. The selected element becomes boxed for reject editing. When selected pressing 1 at pushbutton 2 sets the item to appear in reject level 2, pressing pushbutton 2 sets the item to reject level 2, and pressing pushbutton 3 enables the item to be visible on all reject levels.



Figure 127. HMD Reject Setup Sub Level

**MIDS SETUP.** The MIDS setup page allows you to prioritize which MIDS symbols appear on the HMD:



Figure 128. MIDS SETUP Page

To change the priority order, box the MIDS symbol you wish to reprioritize using the up/down arrows adjacent PB4 and PB5. Then press the SEL button (PB2). SEL will be boxed, and you can use those same up/down arrows to move the MIDS symbol up or down the priority list. Unbox SEL when finished, and press RETURN (PB19) to return to the HMD page.

**CLSTFR BLNK.** When boxed, removes the closest friendly tracks from the display.

**MEMBER BLNK.** When boxed, removes division member tracks from the display.

## Basic HMD Information

The basic features of the HMD can be illustrated in the non-designated mode. All features apply to all HMD modes:

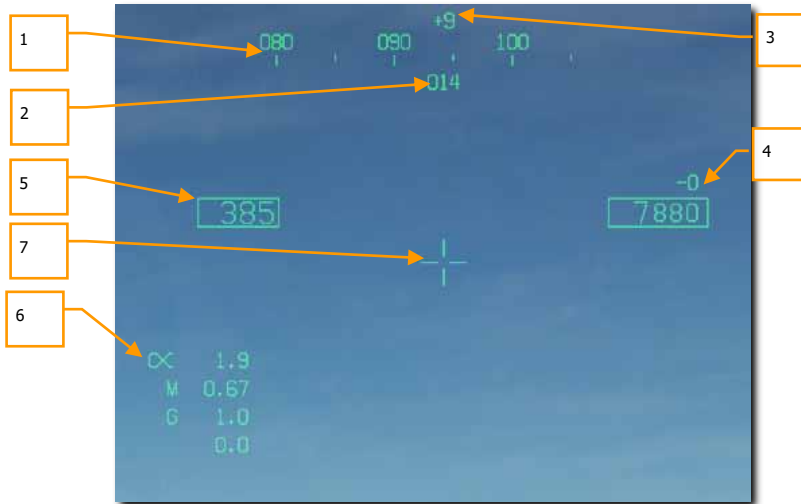

Figure 129. NORMAL HMD Mode

1. **Helmet heading.** Digital heading indication (XXX) of where helmet is pointed. As with the HUD, command heading marks and steering diamond are displayed along the heading tape.
2. **Aircraft heading.** Mirrors HUD heading.
3. **LOS elevation.** Indication line of sight above the horizon in degrees. + and - indications are used before the value.
4. **Altitude and Vertical Velocity.** Duplication of the HUD barometric or radar altitude with the vertical velocity value above.
5. **Calibrated Airspeed.** Duplication of the HUD airspeed.
6. **Angle of Attack, Mach, and g.** Duplication of the Angle of Attack, Mach, and current/peek g.
7. **Dynamic Aiming Cross.** While in A/A mode in the HMD, the aiming cross can be in one of three locations on the HMD, based on HMD view angle.
  - When HMD LOS is 0° or less above the stabilized horizon, the aiming cross is centered in the HMD.
  - When HMD LOS is between 0° and 30° above stabilized horizon, the aiming cross is centered between the airspeed and altitude indicators on the HMD.
  - When HMD LOS is greater than 30° above stabilized horizon, the aiming cross is centered above the heading tape on the HMD.

## AIM-9 Undesignated Target

When A/A mode is selected and an air-to-air missile is selected, much of the symbology is consistent:

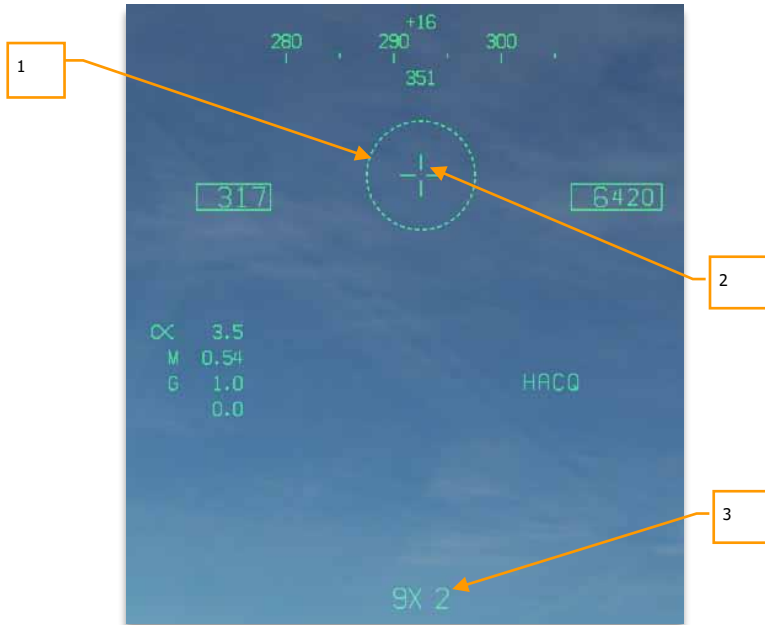

Figure 130. HMD A/A, No Target

1. **Seeker FOV.** This 5° reticle indicates the seeker FOV that it will search if uncaged.
2. **Dynamic Aiming Cross.**
3. **Weapon and quantity.** The SMS code of the selected weapon and number remaining.

## AIM-9 Self-Track

To visually designate a target for the AIM-9 seeker, adjust your view to place the seeker FOV over the target and press and HOLD the Cage/Uncage button on the throttle [C]. Once an AIM-9 seeker is tracking a target and the seeker is uncaged, the seeker reticle will self-track the target. This is indicated by the smaller seeker FOV reticle and the higher-pitched lock tone of the AIM-9 seeker.

## AIM-120 and AIM-7 Undesignated

As with the HUD, the AIM-120 and AIM-7 field of view reticles are displayed on the HMD when the weapons are selected. These are in reference to FLOOD (AIM-7) and VISUAL (AIM-120) modes.

Neither weapon seeker can be slaved to HMD line of sight.

## HMD ACM Modes

When in an ACM mode and the HMD is active, the radar will use either Helmet Acquisition (HACQ) mode or Long-Range Helmet Acquisition (LACQ) mode. The ACM mode must first be selected to Boresight (BST) mode. These are selected by:

- HACQ: Sensor Control Switch forward for less than 800ms
- LACQ: Sensor Control Switch forward for greater than 800ms

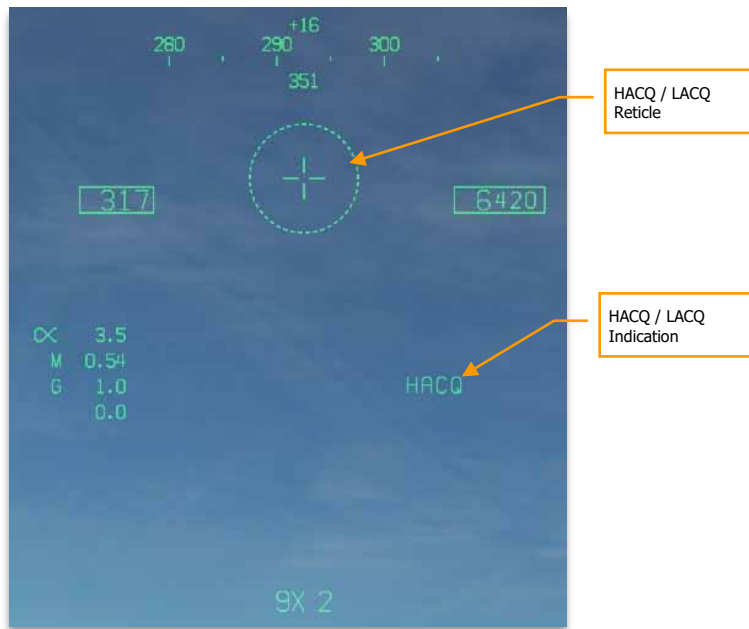

Figure 131. HMD ACM Mode

Using the HMD line of sight, the radar will center its scan on this location. As the HMD line of sight moves, this is reflected on the radar page elevation caret and azimuth indicator B-sweep line. This is in reference to the horizon, not the aircraft.

- HACQ: Auto acquisition of targets out to 10 nm that are within the reticle using MPRF.
- LACQ: Auto acquisition of targets out to 40 nm that are within the reticle using MPRF.

If attempting to slew the radar outside of radar gimbal limits, the HACQ/LACQ symbol will flash.

To break an ACM HMD lock, press the Undesignate button.

## A/A Designated Target

Once an AA target has been locked on radar, new data becomes available:

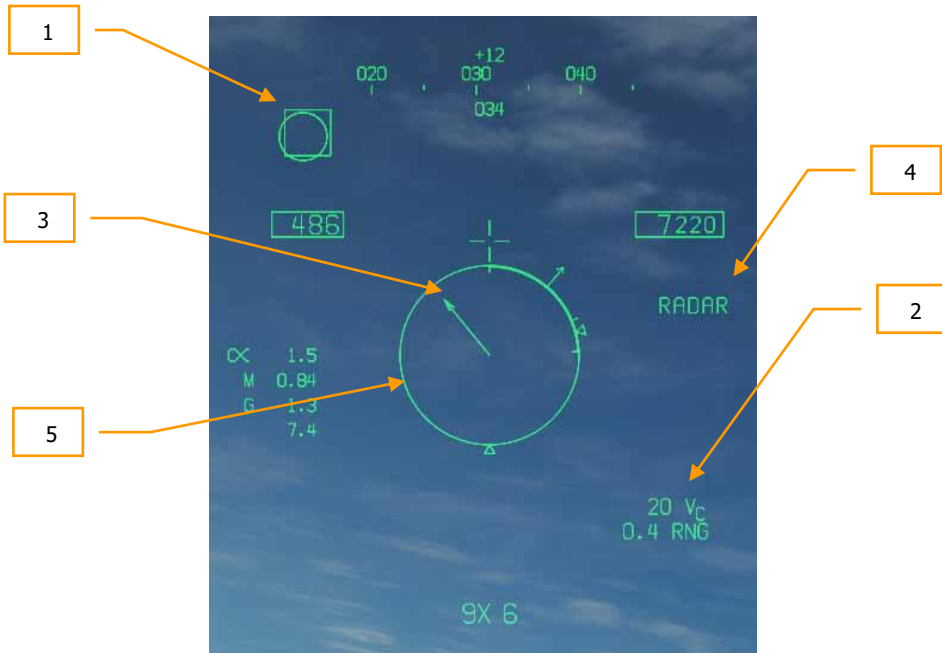

Figure 132. HMD A/A. Locked Target, Outside FOV

1. **Target Designator (TD) box.** Displays line of sight to location of locked target. If outside the HMD FOV, the TD box will be clamped to the display edge.
2. **Closure and Range of Target.** Closure can be displayed as a  $V_c$  (XXX) value that can be negative. Below is the range to target in nm as X.X RNG.
3. **Target Locator Line (TLL).** When the designated air target is outside the HMD display, the TLL will be drawn from the aiming cross to the target, with bearing to the target displayed above the aiming cross. The TLL is not displayed with the angle is less than  $10^\circ$ .
4. **Sensor.** Indication of the sensor being used to track the target, will indicate RADAR.
5. **Normalized in Range Display (NIRD) circle.** This is a  $6^\circ$  diameter circle that is centered in the HMD. Outside of the circle are indications of the missile range envelope. If target tracking is approaching radar gimbal limits, the NIRD will flash. If the target is closer than the  $R_{MIN}$ , an X will flash over the NIRD. Same as NIRD on HUD, including target aspect indication.

Once the target is inside the HMD FOV:

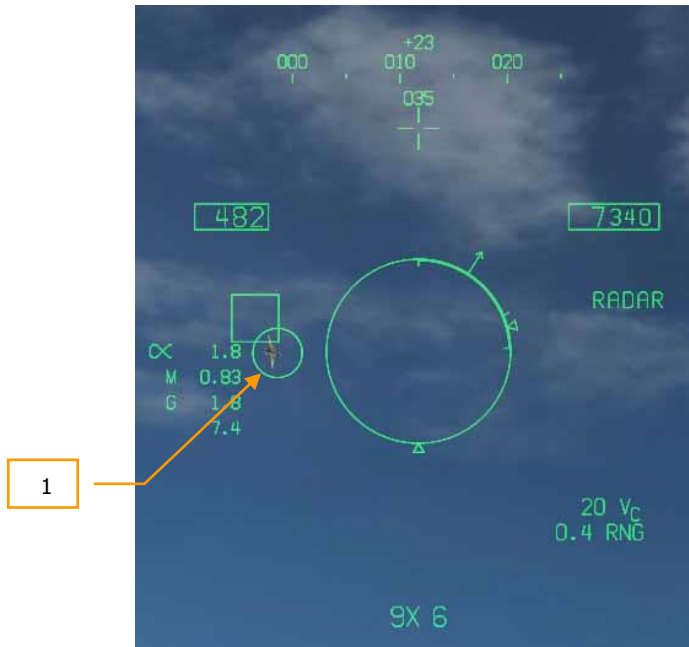

Figure 133. HMD A/A. Locked Target, Inside FOV

1. **Seeker LOS.** The seeker LOS reticle will overlay the TD box, indicating that the seeker is locked to the same radar target.

Not shown:

- **SHOOT cue.** If the target is in valid shot parameters (indicated on NIRD), then the SHOOT cue will appear over the seeker LOS reticle. Same logic as HUD.



# AIR-TO-AIR EMPLOYMENT



US Navy photo  
by PO3 James Vazquez

## AIR-TO-AIR MASTER MODE

For air-to-air weapon employment, you will need to be airborne with landing gear up and have the Master Arm switch set to ARM and A/A selected. When the Master Mode switch in in SAFE, the priority weapon indications on the HUD and radar will have an "X" through them. When in SAFE mode, the SIM training option is available.

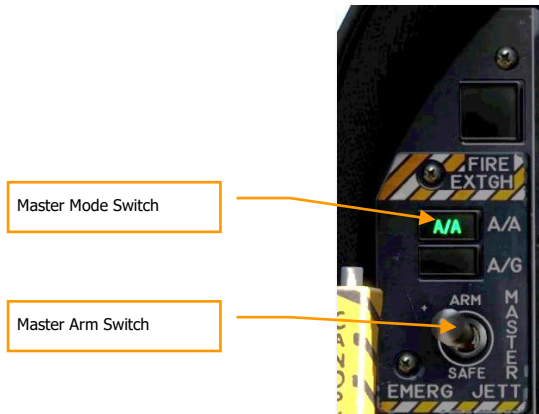

*Figure 134. A/A Master Mode Select*

# M61A1 GUN, AIR-TO-AIR MODE (A/A GUNS)

## Mission Practice: AA Gun and AIM-9 Sidewinder

The A/A-49A1 M61A1 20mm automatic gun system provides the pilot with a formidable A/A weapon capability. The system has a capacity of 578 rounds of ammunition. The rate select switch provides for the selection of either 4,000 or 6,000 shots per minute.

The gun is used for close-in engagements and can either be radar-directed or not.

A/A GUNS is selected by an aft press on the Weapon Select Switch or **[LShift] + [X]**. To fire the gun, press the Trigger on the Control Stick **[Space]**.

### *How to Use the Gun Summary*

1. Master Arm switch to ARM
2. Weapon Select switch to A/A GUNS
3. Fly to place target in dashed circle on the Heads-Up Display (HUD) to lock it on RADAR when at 5 nautical miles or closer
4. Fly to place the dot in the center of the gun reticle over the target and squeeze the trigger when you see the SHOOT cue on the HUD.

## A/A GUNS SMS Page

Regardless of which air-to-air gun mode you select, the air-to-air gun (A/A GUNS) SMS page will remain the same. The SMS page is accessed through the TAC menu DDI page, or it can be automatically called up by selecting A/A GUNS.

The A/A GUNS SMS page allows you to configure the following weapon settings:

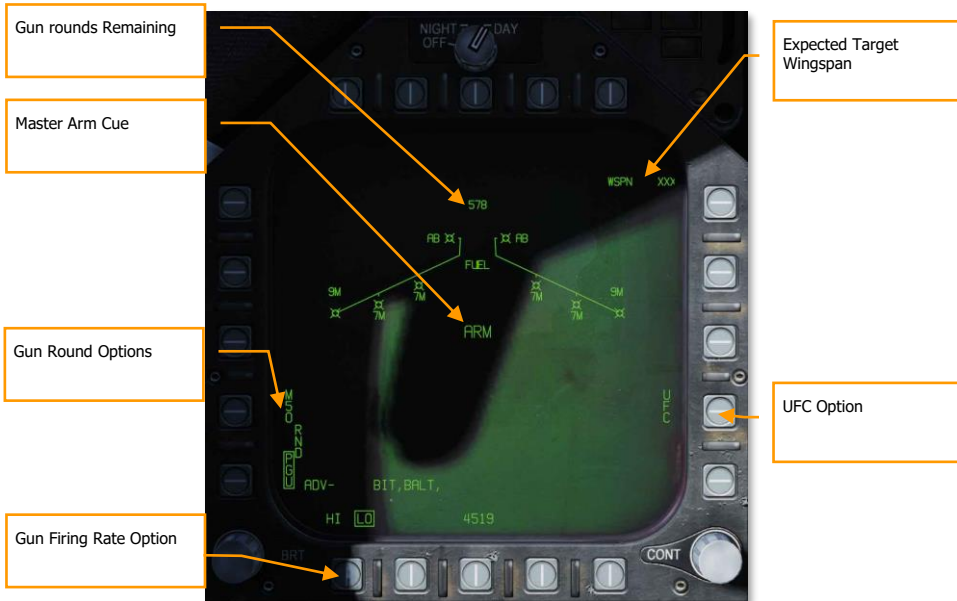

Figure 135. A/A GUNS SMS Page

**Gun rounds Remaining.** Displayed when available. If no rounds remain, XXX is displayed. A full gun load is 578 rounds.

**Gun Round Options.** RND M50/PGU option is provided to select the type of 20mm ammunition which is loaded. The selected ammunition type is boxed. The M50 option represents MK-50 series ammunition and the PGU option represents PGU-28 ammunition.

**Gun Firing Rate Option.** High rate (HI) is initialized on power up, pressing the Option Select Button selects the alternate gun fire rate (LO). Gun fire rate legend is boxed when selected. HI = 6,000 rounds per minute, and LO = 4,000 round per minute.

**Master Arm Cue.** The status of the Master Arm switch (ARM, SAFE) or the selection of simulation mode (SIM) is displayed.

**Expected Target Wingspan.** The UFC is used to program the wingspan size for the expected target. This selection is then used to properly adjust the Funnel Cue. The selectable wingspan values are whole numbers between 10 to 150 with a default of 40 feet. The wingspan value is entered by selecting the UFC Option Select Button 14 on the A/A GUNS SMS page. The current wingspan value is displayed as WSPN XXX. With WSPN displayed, the pilot enters a wingspan value using the keypad, followed by the ENT key.

**UFC Option.** Press to enable manual wingspan entry using the UFC.

## A/A GUNS HUD

The F/A-18C has three functional A/A GUN modes:

- Radar Not Tracking Mode
- Radar Tracking Mode
- Training Mode with FEDS cue

### *Radar Not Tracking Mode*

The Radar Not Tracking Mode, also called the Funnel Mode, is obtained immediately upon A/A GUNS selection if the radar is not already tracking a target or at any time if radar track is lost or broken. To use the funnel, fly to place the target aircraft's wings between the funnel such that its wing tips just touch the sides of the funnel.

A fixed range of 2,000 feet is used for the radar not tracking mode lead angle computations. A 12.5-mil diameter stadia metric reticle, corresponding to a target wingspan of 25 feet at this range, is displayed on the HUD.

Specific symbology to the Radar Not Tracking gun HUD includes:

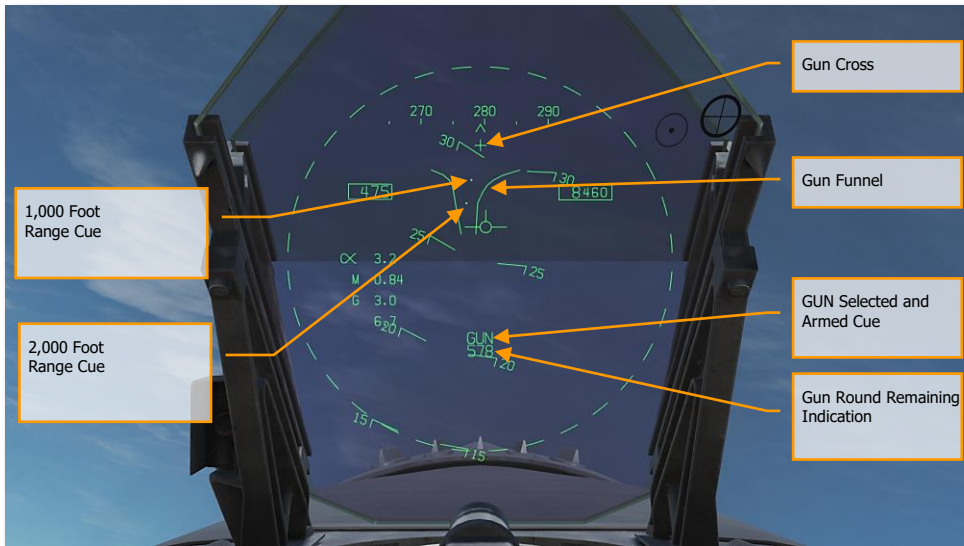

Figure 136. A/A GUNS HUD, Radar Not Tracking Mode

**Gun Cross.** Displayed when A/A gun is selected. The Gun Cross is centered in azimuth and 2° above aircraft waterline to indicate gun boresight.

**Funnel Cue.** The funnel mode is displayed if the radar is not tracking the L&S target, or if lock-on is broken.

**1,000 Foot Range Cue.** A range of 1,000 feet is represented by the pipper.

**2,000 Foot Range Cue.** A range of 2,000 feet is represented by this pipper.

**GUN Selected and Armed Cue.** Indication of the gun being the selected weapon.

**Gun Round Remaining Indication.** Number of gun round remaining.

When A/A GUNS is selected, and the radar is operating, the radar will automatically enter the air-to-air Guns Auto Acquisition mode (GACQ). This is a 5-bar elevation scan with 20° of elevation centered 4° below the radar boresight. This scan covers the entire HUD field of view. This mode also places the radar in a 5-mile range setting. When any aerial target flies within this scan zone, it will automatically be locked on to in Single Target Track (STT).



Figure 137. A/A GUNS Auto Acquisition Area

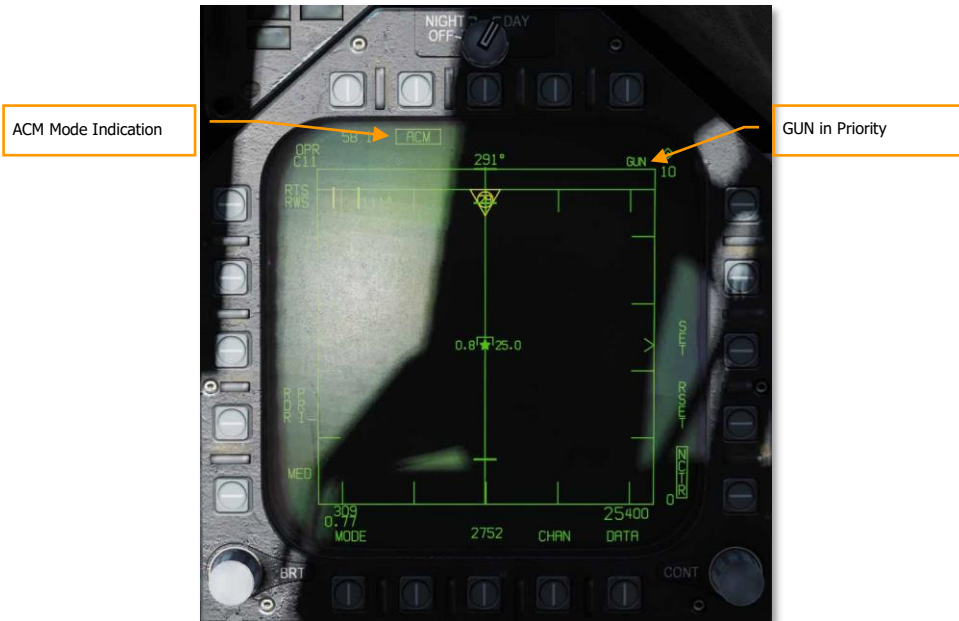

Figure 138. A/A GUNS Acquisition Radar

At any time, you can also select one of the ACM radar sub modes. ACM sub modes are selected by pressing the Sensor Control Switch forward. Once in ACM mode, the Sensor Control Switch can select three ACM sub modes.

- **Boresight (BST)** Sensor Select switch forward
- **Vertical Acquisition (VACQ)** Sensor Select switch aft
- **Wide Acquisition (WACQ)** Sensor Select switch left

Note 1: When the radar is at a 5 nm range setting, ownship airspeed and altitude are displayed inside the radar display.

Note 2: When in a turning fight, VACQ can often be a good choice to lock up a target above your lift vector.

To return to GACQ, select GUNS on the Weapon Select Switch.

## Radar Tracking Mode

Radar Tracking Mode is the primary air-to-air gun mode of the F/A-18C. Radar Tracking Mode is obtained immediately upon gun selection if the radar is tracking an aerial target. Valid range, range rate, and angle tracks are required for Radar Tracking Mode operation.

Once the radar is locked on, the Target Designator (TD) indicates the position of the target being tracked, and target range is displayed on an analog bar on the 50-mil diameter gun reticle along with a maximum firing range cue. Maximum gun firing range corresponds to a maximum bullet time of flight of 1.5 seconds and a minimum impact velocity (bullet  $V_c$ ) of 500 feet per second or a minimum bullet velocity ( $V_b$ ) at impact of 1,000 feet per second, whichever range is less. Maximum firing range is much greater head-on than tail-on.

An advantage of the Radar Tracking Mode is the use of radar track data. The use of track data makes the lead angle computation dependent only on target motion and the encounter geometry. The computed lead angle is essentially independent of aircraft attitude. The Radar Tracking Mode obtains firing solutions quickly since rapid attitude changes have little short-term effect on the required lead angle. As a result, the pilot's task is solely flying to aim the gun reticle since the target tracking function is being performed by the radar.

As a further aid to the pilot and for consistency with the missile modes, a SHOOT cue appears if the target is within maximum firing range. If the predicted miss distance is less than 20 feet, and all other firing constraints (master arm, weight off wheels) are satisfied, the SHOOT CUE comes on. The SHOOT cue includes a 0.5 second anticipation needed for pilot reaction time plus gun delay time. The SHOOT cue remains on until the predicted miss distance exceeds 30 feet.

Radar Tracking Mode is automatically selected if A/A GUNS is selected while there is a radar lock. If there is no radar lock, it will go to Radar Not Tracking Mode.

Elements of the A/A GUNS Radar Tracking Mode on the HUD include:

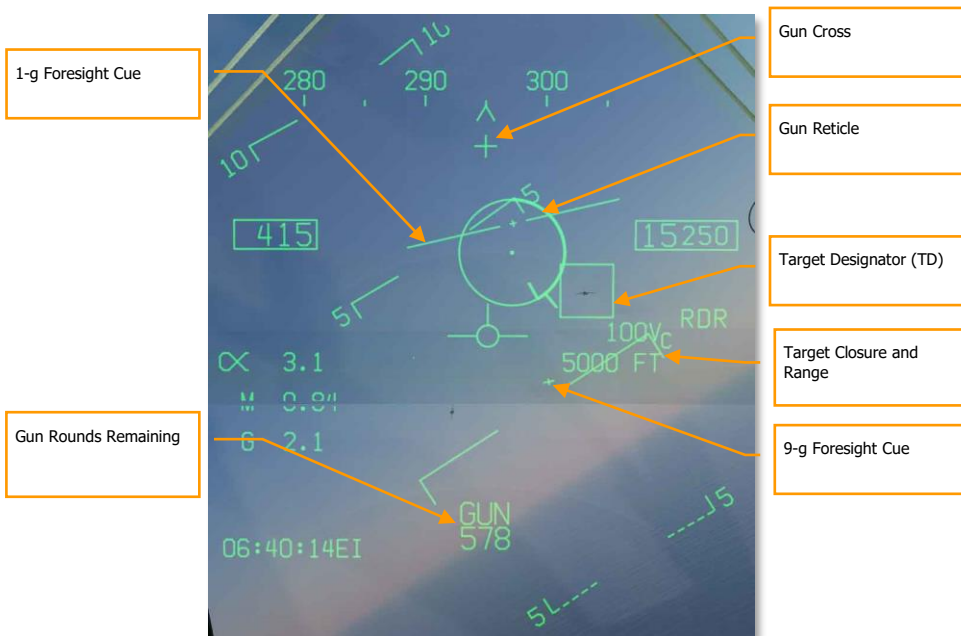



Figure 139. A/A GUNS HUD, Radar Tracking Mode

**Gun Reticle.** This circle indicates predicted gun impact location based on aircraft maneuvering. Radar lock provides target range data that is included in the reticle. A maximum gun firing range cue is displayed on the gun reticle display. It indicates the maximum effective gun firing range. The target analog range bar inscribed in the gun reticle shows the current target range as indicated by radar is presented as a circular arc about the gun reticle, the length of which represents the target range increasing clockwise about the reticle. When the arc's clockwise length is less than the position of the Gun Maximum Range Cue, the target is within the range of the gun.

**1-g and 9-g FORESIGHT Cues.** Fluid Omni-Range/Rate Sight (FORSIGHT). The FORSIGHT cues indicates the targets potential to maneuver. It is made up of two horizontal lines with center tick marks. The upper or longer line represents the targets 1-g left or right out-of-plane maneuver capability under 1 g in-plane loading. The lower or shorter line represents the targets 9-g left or right out-of-plane maneuver capability under 9 g in-plane loading. The distance between the two FORSIGHT cue lines represents the 1-g to 9-g in-plane maneuver potential for the target. The separation between the 1-g and 9-g maneuver potential lines is not limited beyond  $R_{MAX}$  (Gun Maximum Range cue). The 1-g maneuver potential line is limited to the HUD field of view at the same distance from the HUD center used for the gun reticle. When the 1-g maneuver potential line is HUD limited, it is displayed flashing.

**Gun Cross.** The Gun Cross is centered in azimuth and 2° above aircraft waterline to indicate gun boresight.

**Target Designator (TD).** This is an indication of target location. If the target is identified as hostile, the box is rotated 45° to create a diamond symbol and an inverted "V" symbol is placed over the diamond.

**Target Vc and Range.** When a valid radar STT track is established on the target, the target range and closing rate are displayed in nautical miles (NM) and feet/second. These are displayed in the same location as displayed when a missile is the selected weapon. When the target comes within 1NM, the range display reverts to a display of target range in 100's of feet.

**Gun Rounds Remaining.** Gun rounds remaining is displayed next to the GUN legend. XXX is displayed when the MC receives the last rounds signal from the SMS.

Not pictured:

**SHOOT Cue.** The shoot cue is displayed until target miss distance exceeds 30 feet. The shoot cue is provided when the below criteria have been satisfied:

- A/A Gun is selected
- All firing constraints are satisfied
- Radar is in STT on the target
- Target is inside gun  $R_{MAX}$  for the selected round type (MK-50 or PGU-28)
- Target center is within 20 feet of an imaginary line connecting the 1-g and 9-g pippers of the Foresight cue (maximum 20 feet miss distance)

**BATR Cue.** Bullet At Target Range (BATR). The BATR cue displays the real time position of a bullet at target range. The BATR cue serves as a post-fire or hypothetical bullet hit position cue. The cue is updated for each bullet fired as the bullet reaches the applicable target range. The cue is displayed on the HUD when the gun is firing or in SIM mode with the trigger held. The cue is displayed using the gun bore line offset from the target LOS.

**Target Locator Line.** Attached to gun cross, this arrow will point in direction of TD box when TD box is off the HUD field of view. The number of degrees to the target is also displayed next to the arrow.

When the radar is locked on to the target while in A/A GUNS in Single Target Track (STT) mode, the radar picture will appear as shown below. Note that the GACQ is indicated on the left side as the selected radar mode and that your airspeed and altitude are displayed inside the B-scope.

While in STT mode, the radar will automatically change scale based on the range to the locked target.

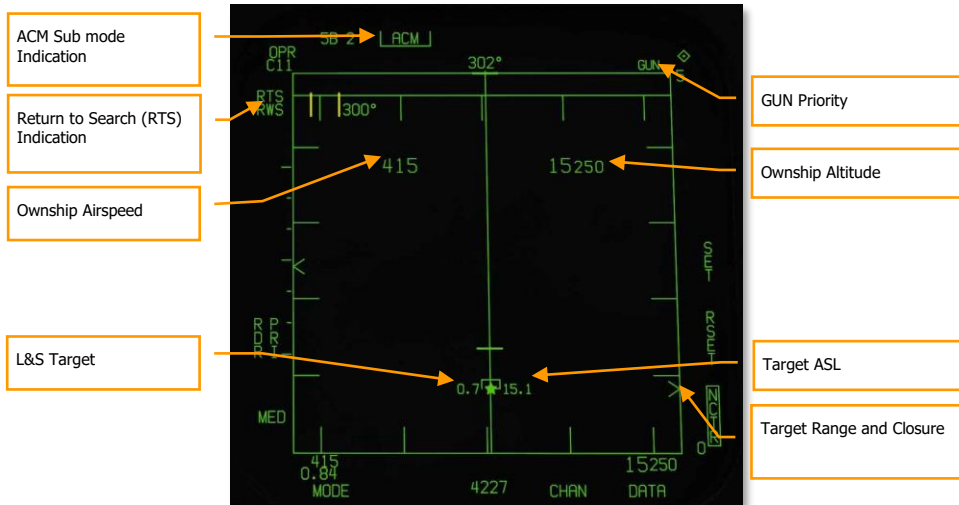

Figure 140. A/A GUNS Radar, Radar Tracking Mode

**ACM Sub mode Indication.** This is a reminder that if an RTS is commanded, it will return to the last ACM mode.

**GUN Priority.** When gun is the priority weapon, GUN is placed in the top right field of the radar display.

**Return to Search (RTS) Indication.** When the radar is in STT mode, the search mode that is entered when an STT lock is disengaged is displayed.

**Ownship Airspeed.** This is displayed when at a 5 nm radar range.

**Ownship Altitude.** This is displayed when at a 5 nm RADAR range.

**L&S Target.** When the target is locked in STT and set as the Launch and Steering (L&S) target, its air speed in Mach is left and of the star symbol and altitude in thousands of feet to the right. When tracked in STT, its aspect pointer is displayed as a line coming from the target symbol.

**Target Range and Closure.** The target closure velocity and range is displayed along the right side range scale.

**Target ASL.** The L&S target will have an Azimuth Steering Line (ASL) running vertically through the target symbol.

Not pictured:

**SHOOT Cue.** The shoot cue is displayed until target miss distance exceeds 30 feet. The shoot cue is provided when the below criteria have been satisfied:

- A/A Gun is selected
- All firing constraints are satisfied
- Radar is in STT on the target
- Target is inside gun  $R_{MAX}$  for the selected round type (MK-50 or PGU-28)
- Target center is within 20 feet of an imaginary line connecting the 1-g and 9-g pipers of the Foresight cue (maximum 20 feet miss distance)

## Training Mode with FEDS Cue

With Master Arm set to SAFE and SIM selected from the GUN SMS format, the FEDS cue can be displayed on the HUD to provide an indication of where the rounds would land when using funnel mode.

**Firing Evaluation Display System (FEDS).** The FEDS display consists of 2 electronic tracer streams separated by target wingspan. The streams are displayed when the gun trigger is depressed to the second detent with the Master ARM in TRAIN and it continues while the trigger is depressed. FEDS projects out to a 2 second TOF.



Figure 141. FEDS Cue

# AIM-9 SIDEWINDER AIR-TO-AIR MISSILE

## Mission Practice: F/A-18C AIM-9 Sidewinder

The AIM-9 is a short-range, infrared-guided missile best used in a dogfight. It is fire-and-forget and can be used with and without a sensor-slaved lock. The primary indication of a seeker lock is a higher-pitched lock tone and the SHOOT cue. The seeker can also be uncaged to ensure the seeker is tracking the target when it has first been sensor-slaved to the target.

Note that the AIM-9 can be decoyed by flares and it's a good idea to ensure you have a good seeker lock before launching an AIM-9 with flares in the seeker field of view.

To select the AIM-9, press down on the Weapon Select Switch on the Control Stick [**LShift**] + [**S**]. Doing so will also automatically activate A/A Master Mode. To launch an AIM-9, press the Trigger on the Control Stick [**Space**].

### *How to Use the AIM-9 Summary*

1. Master Arm switch to ARM
2. Weapon Select Switch to AIM-9
3. Select ACM RADAR sub mode
4. Flying to place target in the ACM RADAR scan mode, as displayed on the Head-Up Display (HUD), over the intended target to lock it on RADAR when at 5 nautical miles or closer
5. Fly to place the Steering Dot inside the ASE/NIRD Circle and squeeze the trigger when you see the SHOOT cue over the Target Designation (TD) box on the HUD

## AIM-9 on the SMS Page

Regardless of which AIM-9 version the pilot selects, the SMS page will appear the same when the AIM-9 is selected. The SMS page is accessed through the TAC menu DDI page, or it can automatically be called up by selecting AIM-9 from the Weapon Select Switch. The selected AIM-9 on the SMS page is indicated by the SEL indication above or below the station. In the case of a dual launcher, it will be indicated as either the L (left) or R (right) rail. For example: L SEL would indicate the left rail in the indication as the priority station.

Each included AIM-9 variant has a unique alpha numeric indication on the SMS page.

- CATM-9M = TST. This is a training version of the AIM-9 with an inert motor and warhead.
- AIM-9L = 9L. The first true all-aspect AIM-9 with a more sensitive seeker and limited forward quarter engagement capability.
- AIM-9M = 9M. An improved version of the AIM-9L with improved seeker ability to detect and track medium to low aspect targets and improved counter-counter measure capabilities.
- AIM-9X = 9X. The current version of the AIM-9 adds high off boresight capability, thrust vectoring, high flare resistance, and greater range.

You can cycle through all AIM-9 loaded stations with repeatedly selecting AIM-9 on the Weapon Select Switch.

Unlike the other air-to-air weapons, there are no unique AIM-9 functions on the SMS page.

The SMS page presents the following indications:



Figure 142. AIM-9 SMS Page

- Missile Form
- Selected (SEL) Missile Indication
- Unselected Missile Indication
- SAFE / ARM Indication
- Missile Designation

## AIM-9 HUD

There are three primary presentations of the AIM-9 HUD:

- Not locked and no radar acquisition mode
- Not locked but in a radar acquisition mode
- Radar locked

### *Not Locked and No Radar Acquisition Mode (Seeker Boresight Mode)*

When the AIM-9 is selected without a radar lock and no radar acquisition mode is active, the AIM-9 seeker boresight reticle is indicated on the HUD. To use the AIM-9 in this manner, the pilot will fly the aircraft and place the seeker boresight reticle over an aerial target until the audio threshold is exceeded and: the angle of coincidence is no more than 15° of aircraft boresight; and the seeker is uncaged. a high-pitched lock tone is heard. With seeker lock acquired, pulling the trigger on the Control Stick will launch the missile.

When the AIM-9 seeker is locked on a target, it can be uncaged by pressing the Cage/Uncage button on the Throttles to allow the seeker lock on and follow the target within the confines of the missile seeker's field of view. This is a useful tool to ensure the seeker is tracking the desired target.



Figure 143. AIM-9 HUD, Seeker Boresight

This is a stealthy way to conduct an AIM-9 attack as it can be done without use of radar.

### *Not Locked but in Radar Acquisition Mode*

When employing the AIM-9 in close range combat, one of the radar Air Combat Maneuvering (ACM) auto acquisition modes can be used to lock a target and then slave the AIM-9 seeker to that target. To select the ACM modes, press the Sensor Control Switch forward. Once in ACM mode, three ACM modes are available:

- **Boresight (BST)** Sensor Select switch forward
- **Vertical Acquisition (VACQ)** Sensor Select switch aft
- **Wide Acquisition (WACQ)** Sensor Select switch left

These are explained in greater detail in Air Combat Maneuvering (ACM) Modes.

When in an ACM mode, the radar will indicate that it is in ACM mode and the specific ACM acquisition mode.

When a target is within the scan zone of the select auto acquisition mode, it will automatically be locked in a Single Target Track (STT) mode and the HUD will change to the AIM-9 sensor locked target mode. Use the best ACM acquisition mode to match the combat situation.

Please refer to the Air-to-Air Radar chapter for an explanation of the radar ACM modes.

## Radar Locked Mode

Upon locking a target with the AIM-9 as the priority weapon, the HUD will change to provide useful information regarding target location, weapon ranges, and other data to assist in a successful engagement. While the radar is in Single Target Track (STT) mode, the radar range scale will automatically be adjusted based on the range to the locked target.

Elements of the AIM-9 HUD with radar lock include:

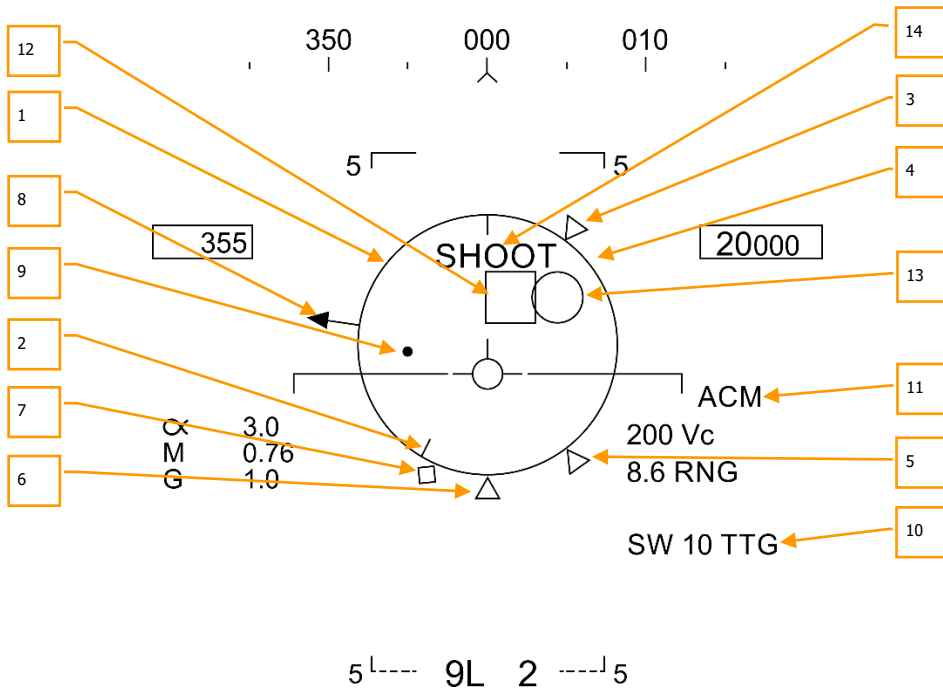

Figure 144. AIM-9 HUD, Radar Locked Target

1. **Normalized In-Range Display (NIRD) / Allowable Steering Error (ASE) Circle.** The NIRD circle is centered on the aircraft waterline and relative range markers are displayed inside and outside of the circle. Relative range is calculated from the 12 o'clock position and increases clockwise. Rather than changing in size of the NIRD/ASE circle based on target intercept changes, the Steering Dot rate of change is adjusted.
2. **Relative Target Range.** Relative range of the target on the NIRD circle in relation to the missile range cues.
3. **Minimum Launch Range.** Computed minimum launch range for the priority AIM-9.
4. **Gun Maximum Range.** Indicated the maximum range for a valid gun shot and more than 12,000 feet. (Coming later in Open Beta)



5. **No Escape Range ( $R_{NE}$ ).** This is the calculated range at which the target will remain within maximum range even if the target turns instantaneously 180° aspect.
6. **Maximum Launch Range ( $R_{MAX}$ ).** Computed maximum range of the missile against the locked target.
7.  **$R_{AERO}$ .** Maximum aerodynamic range is displayed when the launch aircraft has more velocity than the missile, but the missile is still capable of a 5-g maneuver.
8. **Target Aspect Angle Pointer.** Displays relative target heading.
9. **Steering Dot.** The Steering Dot in conjunction with the NIRD/ASE circle indicates lead angle steering to the locked target. The pilot should fly to place the Steering Dot inside the NIRD/ASE circle to satisfy lead angle computations. The Steering Dot will flash when within 15° of the radar's azimuth limit and when within 5° of the radar's elevation limit.
10. **AIM-9 Time of Flight.** Displays the calculated time in seconds before launch for missile to reach locked targets. After launch, Time to Go (TTG) and SW suffix are added indicate calculated missile time to impact.
11. **ACM Sub mode Cue.** ACM is displayed when the system is in an ACM sub mode.
12. **Target Designator (TD).** This box indicates the line of sight between the aircraft and the primary locked target. If the locked target is outside the HUD field of view, the TD box flashes. If the target is identified as hostile, the box is rotated 45° to create a diamond symbol and an inverted "V" symbol is placed over the diamond.
13. **AIM-9 Seeker Circle.** Indicates the seeker head position of the AIM-9. If the seeker is pointed outside the HUD field of view, the circle flashes. When the AIM-9 is slaved to the locked radar target, the TD box and AIM-9 Seeker Circle will coincide.
14. **Shoot Cue.** The word "SHOOT" is displayed above the TD box/diamond when AIM-9 shoot conditions are satisfied. If the locked target is in the no escape zone ( $R_{NE}$ ), the Shoot Cue flashes.

With a radar lock on the target for an AIM-9 launch, several pieces of important information are presented on the radar display. Much of the information on the radar mirrors that on the HUD.

Note that when the target is outside the HUD field of view, the Target Locator Line appears and points in the direction of the target. Additionally, degrees to the target is displayed next to the arrow.

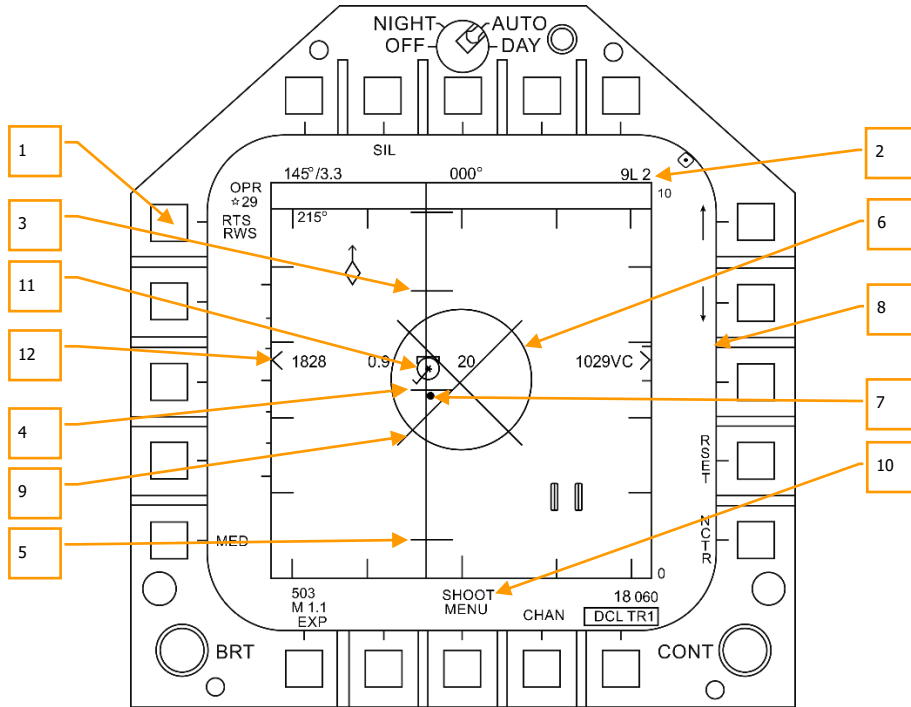

Figure 145. AIM-9 Radar, Radar Locked Target

Return to Search (RTS) indication with RWS to be the return mode

1. Priority weapon and number remaining
2.  $R_{MAX}$
3.  $R_{NE}$
4.  $R_{MIN}$
5. ASE Circle
6. Steering Dot
7. Target Closure Velocity and Range
8. Breakaway "X"
9. Shoot Cue
10. Locked target in STT radar mode with airspeed in Mach to the left, altitude in thousands of feet to the right, and velocity vector line. The Star symbol indicates that is the Launch and Steering (L&S) target
11. Altitude Differential

Note that the range cues on the HUD and attack radar mirror each other, but use a different presentation format:

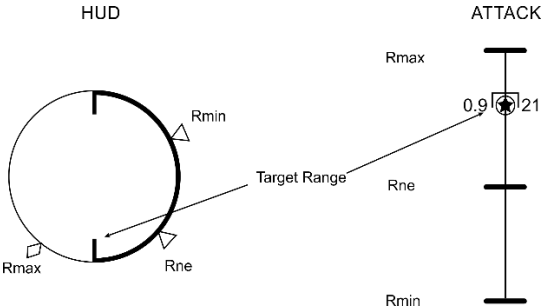

Figure 146. Weapon Range Cues

# AIM-7 SPARROW AIR-TO-AIR MISSILE

## Mission Practice: F/A-18C AIM-7 Sparrow

The AIM-7 Sparrow is a Semi-Active Radar Homing (SARH) missile that requires the radar to be tracking the target in Single Target Track (STT) mode the entire missile time-of-flight (Home-On-Jam being the exception). The AIM-7 has a large warhead and can engage targets beyond visual range as well as in close combat. The AIM-7 can be a deadly missile in close combat when combined with the radar ACM sub modes.

The AIM-7 also has the FLOOD mode that allows it to launch and guide on a non-locked target, and it has a LOFT option for extended range.

To select the AIM-7, push forward on the Weapon Select Switch on the CONTROL STICK [LShift] + [W]. Selecting AIM-7 will automatically place the Master Mode in A/A.

The radar must be in Single Target Track (STT) mode to support guidance for an AIM-7. This can be done by pressing the Cage/Uncage button less than .8 seconds when there is an L&S target. Alternatively, you may press right on the Sensor Control switch when the radar is on the right DDI and the target TDC is already over the target on the radar.

### *How to Use the AIM-7 Summary*

1. Master Arm switch to ARM
2. Weapon Select switch to AIM-7
3. Set TDC to attack RADAR page
4. Designate target on RADAR to Single Target Track (STT) or select ACM RADAR sub mode and fly to place target in ACM RADAR scan mode, as displayed on the Heads-Up Display (HUD), over the intended target to lock it on RADAR when at 5 nautical miles or closer
5. Fly to place the Steering Dot inside the ASE Circle and squeeze the trigger when you see the SHOOT cue over the Target Designation box on the HUD.

## AIM-7 SMS Page

When selected as the priority weapon, the Stores pages includes the following information and options for the AIM-7:

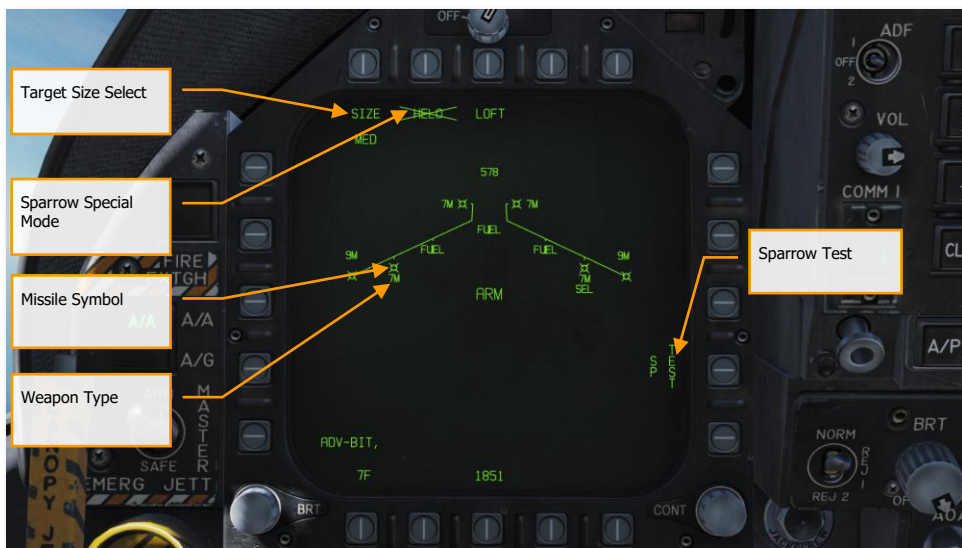

Figure 147. AIM-7 SMS Page

**Missile Symbol.** Missile shape indicating AIM-7 loaded on the station.

**Weapon Type.** AIM-7 alphanumeric, which will either be 7F or 7M. The priority AIM-7 will have a SEL below this indication.

**Target Size Select.** Allows selection of missile fuzing based on intended target size. This can be cycled between SML, MED, and LRG. When this option button is pressed, each option is shown as a separate Option Select Button across the top of the page.

**Sparrow Special Mode.** This mode is only used for engagement of helicopters. When enabled, HELO appears below the Option Select Button. When disabled, an "X" is through the HELO legend.

**Sparrow Test.** All Sparrows must be tuned before they are employed. The initial tune occurs at the end of the Radar Operational Readiness Test and after the SMS has applied power to the missile for approximately three minutes. The three-minute warm-up time begins at the completion of the SMS BIT and weapon inventory. When the tune process begins, the TEST portion of the SP TEST option is boxed. The radar provides a missile compatible PDI sample to the missile. The SMS receives a Missile Ready Signal from each missile that has been successfully tuned. Successful tune of a Sparrow is indicated by the removal of the "X" overlaying the 7F or 7M on the SMS page.

## AIM-7, No Radar Tracking

When an AIM-7 is the priority weapon and no target has been designated with a sensor, the AIM-7 HUD includes the following indicators in addition to the standard air to air mode HUD indications:

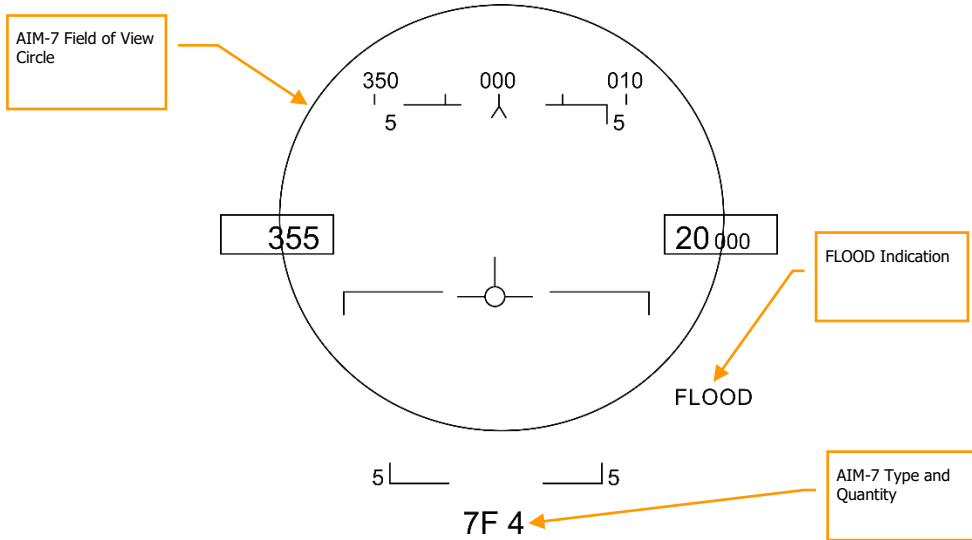

Figure 148. AIM-7 HUD, No Target

**AIM-7 Field of View Circle.** Displayed when AIM-7 is in priority, but no target has been designated. This also delineates the FLOOD antenna coverage field of view.

**AIM-7 Type and Quantity.** Displays the type of AIM-7 in priority (7M or 7F) and the number of the missile type remaining.

**FLOOD Indication.** If an AIM-7 is launched with no radar lock, the radar and missile will automatically enter FLOOD mode as indicated on the HUD. Note that this indication is only visible if an AIM-7 has been launched with no radar lock.

### FLOOD Mode

With an AIM-7 launch with no radar lock, the radar will change to FLOOD mode and use the illumination horn on the radar to illuminate the airspace delineated by AIM-7 ASE circle on the HUD. By flying to keep a target within this circle, the seeker of the AIM-7 will attempt to lock on to and guide on the nearest target. This is effective out to 10 nm.

Note that FLOOD mode forces the AIM-7 into pure-pursuit guidance and can be very inefficient against crossing targets. FLOOD mode is best used against very high or very low aspect targets.

FLOOD mode can be a useful mode in a dogfight when you cannot gain a radar lock.

To exit FLOOD mode, press the Undesignate Button.

### AIM-7 Default Radar Settings

When AIM-7 is selected as the priority weapon, the radar will default to the following settings unless a SET profile was already created:

- 140° azimuth
- 4-bar elevation scan
- 40 nm range
- 8 seconds aging
- Interleaved PRF

When the AIM-7 is the priority weapon, but no target has been designated, the radar includes the following information:

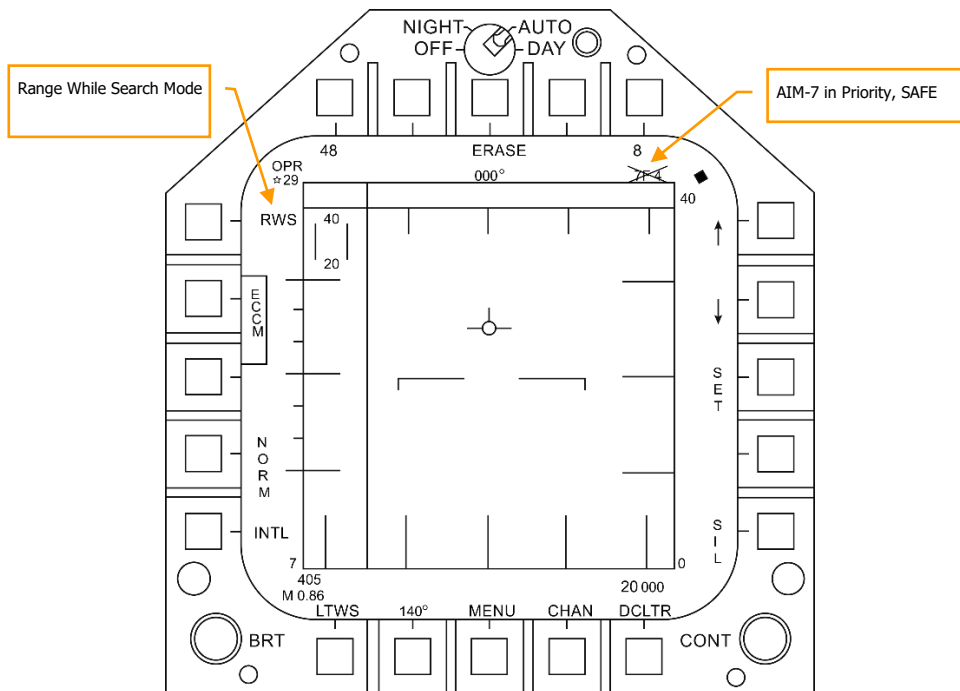

Figure 149. AIM-7 Radar, No Lock

## AIM-7, Radar Tracking

With an L&S trackfile created for a target, additional engagement information is displayed on the HUD and radar. As with the AIM-9 sensor-locked mode, this additional information includes multiple weapon range cues, target closure and aspect, target range, and other information to help provide a successful AIM-7 engagement.

If though the target is being tracked but not in Single Track Target (STT) mode, a "GO STT" cue is displayed on the HUD to remind the pilot to achieve an STT lock before launching the missile.

Components of the AIM-7 HUD with a radar-locked target include:

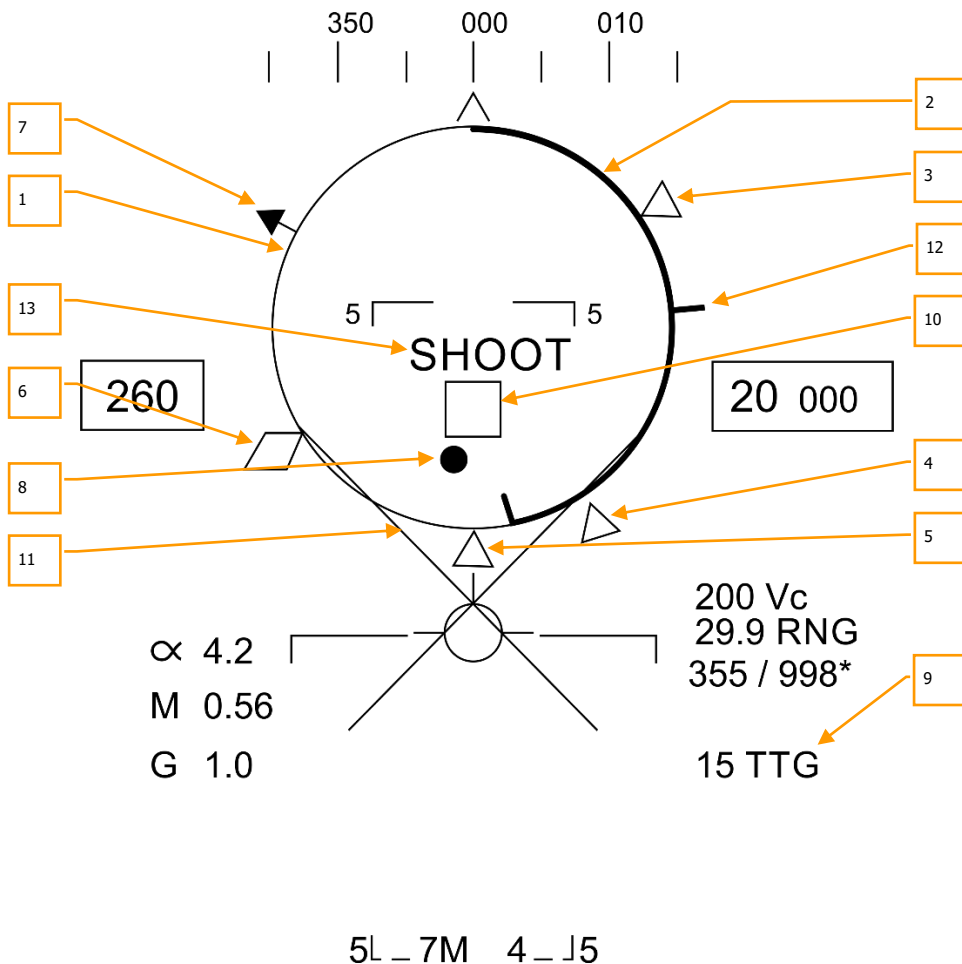

Figure 150. AIM-7 HUD with L&S Target



1. **Normalized In-Range Display (NIRD) / Allowable Steering Error (ASE) Circle.** The NIRD circle is centered on the aircraft waterline and relative range markers are displayed inside and outside of the circle. Relative range is calculated from the 12 o'clock position and increases clockwise.  
Rather than changing in size of the NIRD/ASE circle based on target intercept changes, the Steering Dot rate of change is adjusted.
2. **Relative Target Range.** Relative range of the target on the NIRD circle in relation to the missile range cues.
3. **Minimum Launch Range.** Computed minimum launch range for the priority AIM-7.
4. **No Escape Range ( $R_{NE}$ ).** This is the calculated range at which the target will remain within maximum range even if the target turns instantaneously 180° aspect.
5. **Maximum Launch Range ( $R_{MAX}$ ).** Computed maximum range of the missile against a locked, non-maneuvering target.
6.  **$R_{AERO}$ .** Maximum aerodynamic range is displayed when the launch aircraft has more velocity than the missile, but the missile is still capable of a 5 g maneuver.
7. **Target Aspect Angle Pointer.** Displays relative target heading.
8. **Steering Dot.** The Steering Dot in conjunction with the NIRD/ASE circle indicates lead angle steering to the locked target. Fly to place the Steering Dot inside the NIRD/ASE circle to satisfy lead angle computations. The Steering Dot will flash when within 15° of the radar's azimuth limit and when within 5° of the radar's elevation limit.
9. **AIM-7 Time of Flight.** Displays the calculated time in seconds for missile to reach the locked target. After launch, Time to Go (SP TTG) suffix is added indicate calculated missile time to impact.
10. **Target Designator (TD).** This box/diamond indicates the line of sight between the aircraft and the primary locked target. If the locked target is outside the HUD field of view, the TD box flashes. A "GO STT" cue is displayed below the TD if the radar is not tracking the target in Single Track Target mode.  
  
If radar tracking on the target is lost, the TD box will be hashed to indicate the radar is in memory (MEM) mode and extrapolating its position to reacquire it.  
  
If the target is identified as hostile, the box is rotated 45° to create a diamond symbol and an inverted "V" symbol is placed over the diamond.
11. **Breakaway X.** Displayed when range to target is less than Minimum Range Cue.
12. **Gun Maximum Range.** Indicates the maximum range for a valid gun shot and more than 12,000 feet.
13. **Shoot Cue.** The word SHOOT is displayed above the TD box when AIM-7 shoot conditions are satisfied. If the locked target is in the no escape zone ( $R_{NE}$ ), the Shoot Cue flashes.

Note that when the target is outside the HUD field of view, the Target Locator Line appears and points in the direction of the target.

Additionally, degrees to the target is displayed next to the arrow.

## AIM-7 with L&S Target

With an AIM-7 as the priority weapon and the target locked in STT on the radar, the radar provides the following useful information that is pertinent to an AIM-7 engagement:

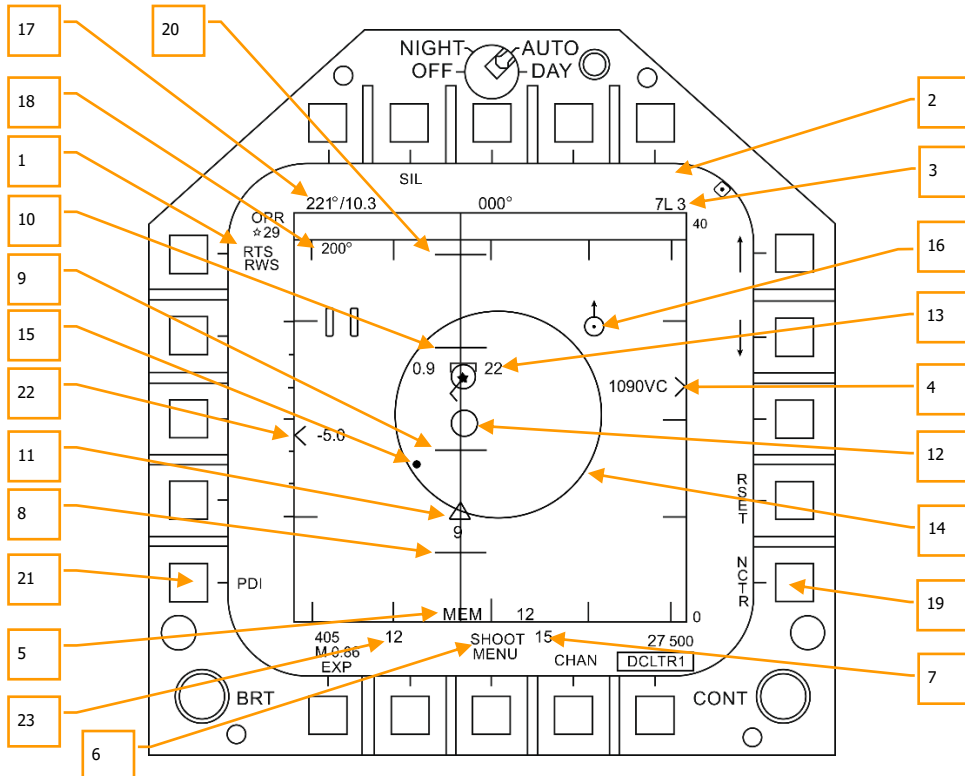

Figure 151. AIM-7 Radar with L&S Target

1. **Return to Search (RTS) Indication.** Single Track Target (STT) mode with Return to Search (RTS) indication.
2. **FLOOD Indication.** This field will display the FLOOD indication when the AIM-7 is commanded to FLOOD mode. (Coming later in Open Beta)
3. **Selected Weapon and Number Remaining.** AIM-7 as Priority Weapon and Remaining Number.
4. **Target Range and Closure Indication.** The range of the target is indicated in reference to the range scale and selected radar range display setting. Left of the caret, closure velocity (Vc) is indicated.
5. **Memory Mode indication and Memory Track Time.** If the radar loses track on the target, it will automatically enter memory (MEM) mode. During this period, the radar will attempt to reacquire the

target and the amount of time the radar is in memory mode is displayed in seconds to the right. (Coming later in Open Beta)

6. **Shoot and Lost Cue.** When the target is within  $R_{MAX}$  range, the Shoot Cue appears as solid. When the target range is within  $R_{NE}$ , the Shoot Cue flashes.
7. **Missile Time of Flight.** This indicates the estimated Time of Flight for the un-launched missile to reach the locked target. Once the missile has been launched, the missile fly-out indication displays missile time to go.
8.  **$R_{MIN}$ .** Calculated minimum launch distance.
9.  **$R_{NE}$ .** Calculated no escape distance.
10.  **$R_{MAX}$ .** Calculated maximum range distance.
11. **AIM-7 Fly-Out indication and Time to Go.** Graphically displays the fly-out of the AIM-7 and the estimated Time to Go (TTG) until target intercept.
12. **AIM-7 Max Seeker Range Cue.** This small circle appears on the azimuth steering line when the AIM-7 is in STT and LOFT is selected. The cue indicates the range at which the AIM-7 Semi-Active Radar Homing (SARH) seeker can guide of radar illumination off the locked target. If LOFT is not selected, the cue only appears when the SARH seeker range is less than the target range and the target is between  $R_{MIN}$  and  $R_{MAX}$ . (Coming later in Open Beta)
13. **Locked Target.** Around the L&S star symbol, target information is displayed that includes Acceleration Vector, Target Aspect Angle Pointer, Tracked Target indication, Target Altitude in thousands of feet, and Target Airspeed in Mach.  

The Acceleration Vector is displayed in the direction of acceleration, perpendicular to the target heading vector when the target exceeds 3 g. The length of the Acceleration Vector lengthens with greater target g.
14. **Allowable Steering Error (ASE) Circle.** Static ASE circle for the AIM-7.
15. **Steering Dot.** In conjunction with the ASE circle, the Steering Dot indicates lead angle steering to the locked target. Fly to place the Steering Dot inside the ASE circle to satisfy lead angle computations. The Steering Dot will flash when within 15° of the radar's azimuth limit and when within 5° of the radar's elevation limit.
16. **Air-to-Air Waypoint with North Arrow.** This is only displayed when selected from the HSI A/AWP option and the waypoint is within the radar's field of view. (Coming later in Open Beta)
17. **Target Bearing and Range to Air-to-Air Waypoint.** If an air-to-air waypoint has been created from the HSI/DATA/A/C sublevel, the bearing and range to that waypoint is indicated in this field. (Coming later in Open Beta)
18. **Target Heading.** Flight heading of the L&S target.
19. **Non-Cooperative Target Recognition (NCTR).** When enabled, the radar will attempt to identify the L&S target based on unique radar reflections. (Coming later in Open Beta)
20.  **$R_{LOFT}$ .** Maximum range using a LOFT launch.
21. **Pulse Doppler Illuminator (PDI) indication.** When the AIM-7 is launched, it requires PDI illumination to track the target. PDI is displayed when this illumination occurs.

22. **Target Altitude Differential.** Displays the difference in altitude between the target and ownship in thousands of feet.
23. **Maximum Aspect Cue.** This cue can range from 1 to 18 and indicates shot quality. The higher the number, the greater probability of missile intercept.

# AIM-120 ADVANCED MEDIUM RANGE AIR-TO-AIR MISSILE (AMRAAM)

## Mission Practice: AIM-120B/C Practice

The AIM-120 AMRAAM is an Active Radar-Homing (ARH) air-to-air missile that can self-guide to a target using the miniaturized-radar in its nose cone. The missile can also be guided by the F/A-18C's radar in both Single Target Track (STT) and Designated Track While Scan (DTWS) modes. Because of the active seeker, the F/A-18C pilot can engage multiple targets at once and not be restricted to supporting the missile its entire time of flight.

The AIM-120 is a medium range missile and can engage targets outside 20 nm. However, engagement range is highly dependent on target aspect, engagement altitude, launch speed, and post-launch maneuvers of the target. As such, the engagement range of the AIM-120 can be less than 10 nm in some situations.

In close range air combat, the AIM-120 can also be launched in VISUAL mode with no need of support from the F/A-18C's radar. Once the missile is launched, it will seek out the first target it detects within the AIM-120 reticle on the HUD. Be careful of friendlies!

To select the AIM-120, push right on the Weapon Select Switch on the stick [LShift] + [D]. Selecting AIM-120 will automatically place the Master Mode in A/A.

### *How to Use the AIM-120 Summary*

1. Master Arm switch to ARM
2. Weapon Select switch to AIM-120
3. Set TDC to attack RADAR page
4. Designate target on RADAR to Single Target Track (STT) or select ACM RADAR sub mode and fly to place target in ACM RADAR scan mode, as displayed on the Heads-Up Display (HUD), over the intended target to lock it on RADAR when at 5 nautical miles or closer
5. Fly to place the Steering Dot inside the ASE Circle and squeeze the trigger when you see the SHOOT cue over the Target Designation box on the HUD.

## AIM-120 SMS Page

When selected as the priority weapon, the Stores pages includes the following information and options for the AIM-120:

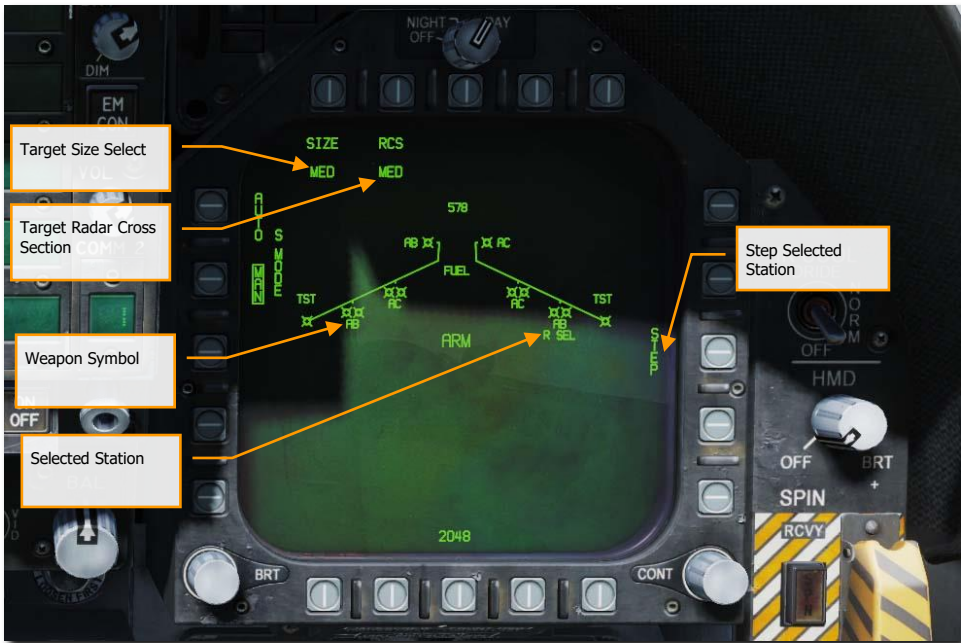

Figure 152. AIM-120 Stores Page

**Missile Symbol.** Missile shape indicating AIM-120 loaded on the station. Up to two AIM-120 can be loaded on stations 2, 3, 7, and 8. Below the symbol(s), the type of AIM-120 is indicated as AB for AIM-120B and AC as AIM-120C.

**Selected Station.** The selected AIM-120 is indicated by "SEL" displayed below the missile symbol(s) and name. If a dual launcher station is selected, the selection indication is displayed as "R SEL" for selection of the right missile rail on the station, or "L SEL" for the left missile rail.

**Step Selected Station.** Successive pressing of pushbutton 13 cycles each station an AIM-120 is loaded. Upon reaching the last station, the selection process wraps back to the currently selected station.

**Target Size Select.** Allows selection of missile fuzing based on intended target size. This can be cycled between SML (small), MED (medium), and LRG (large). When this pushbutton is pressed, each option is shown as a separate pushbutton across the top of the Stores page.

**Target Radar Cross Section.** Allows selection of missile radar seeker priority based on the radar cross section of the intended target. This can be cycled between SML, MED, and LRG. When this pushbutton is pressed, each option is shown as a separate pushbutton across the top of the Stores page.

In addition to STEPPING through stations to select and AIM-120, repeated presses of the AIM-120 select switch on the control stick via the Weapon Selection switch will cycle through AIM-120 stations.

## AIM-120, No Radar Tracking

When an AIM-120 is selected and no target has been designated with a sensor, the AIM-120 HUD includes the following indicators in addition to the standard air to air mode HUD indications:



Figure 153. AIM-120 HUD, No Target

**AIM-120 Field of View Circle.** Displayed when AIM-120 is selected but no target has been designated. This also delineates the field of view of the AIM-120 antenna for a VISUAL launch.

**AIM-120 Type and Quantity.** Displays the type of AIM-120 in priority (AB or AC) and the number of the missile type remaining.

**AIM-120 VISUAL Mode Indication.** When there is no target being track by a sensor that can slave the AIM-120, the system is in VISUAL mode as indicated in the bottom center of the HUD. When launched in this mode, the AIM-120 will engage the first target detected by its onboard radar upon leaving the launch rail.

When AIM-120 is selected, the radar will default to the followings settings unless a SET profile was already created:

- 140° azimuth
- 2-bar elevation scan
- 40 nm range
- 4 seconds aging
- Interleaved PRF

When the AIM-120 is selected but no target has been designated, the radar appears as shown below. The only unique element is the weapon name and quantity indication.

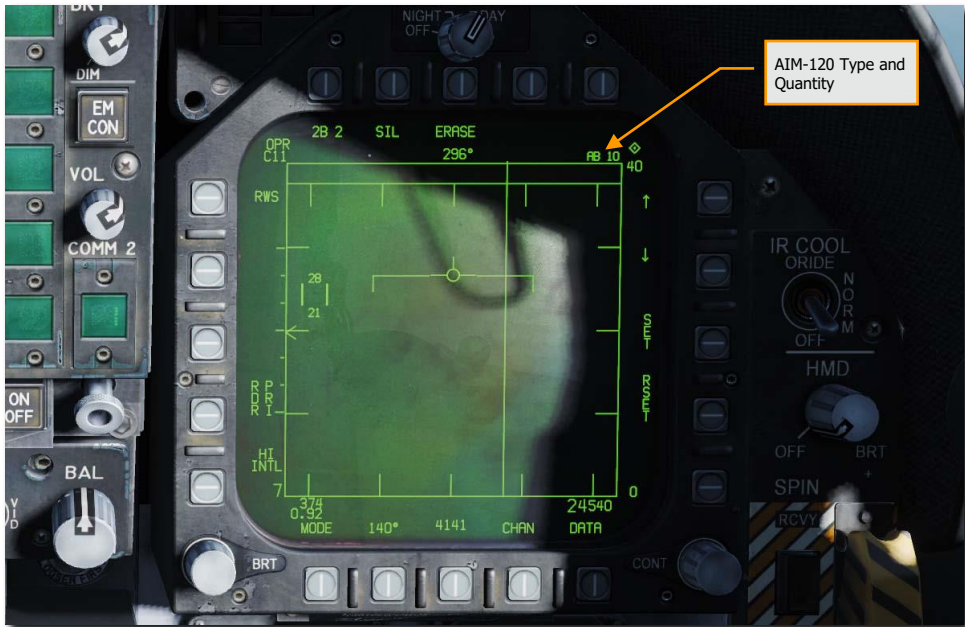

Figure 154. AIM-120 Radar, No Lock



## AIM-120, Radar Tracking Pre-Launch

With an L&S trackfile created for a target, additional engagement information is displayed on the HUD and radar to support an AIM-120 launch. As with the AIM-7 sensor-locked mode, this additional information includes multiple weapon range cues, target closure and aspect, target range, and other information to help provide a successful AIM-120 engagement. The primary difference being that the AIM-120 does not require an STT lock during the entire missile fly-out to intercept. Instead, once the AIM-120 seeker goes active, the player no longer needs to keep a radar lock on the target.

Let's take a look at the HUD and radar when a target has been locked with an AIM-120 selected.

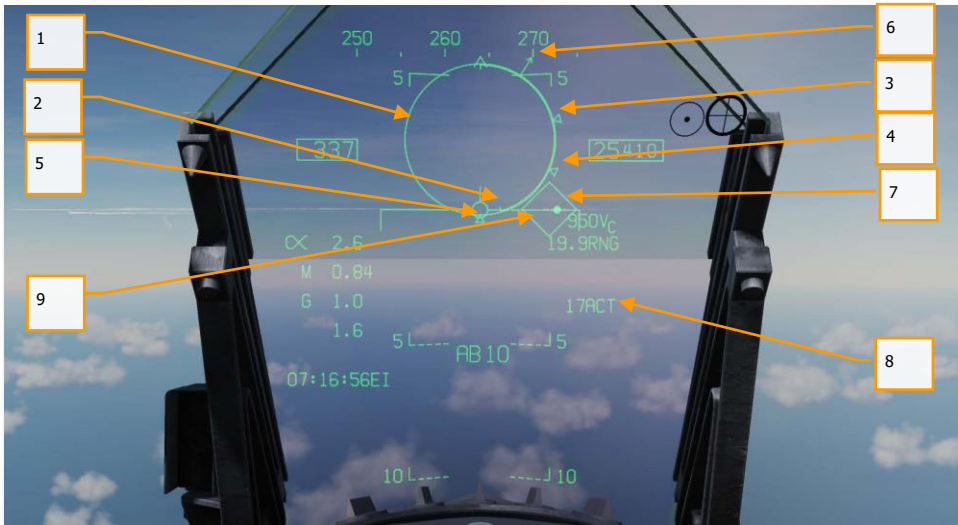

Figure 155. AIM-120 HUD with Radar Lock, Pre-Launch

1. **Normalized In-Range Display (NIRD) / Allowable Steering Error (ASE) Circle.** The NIRD circle is centered on the aircraft waterline and relative range markers are displayed inside and outside of the circle. Relative range is calculated from the 12 o'clock position and increases clockwise. Rather than changing in size of the NIRD/ASE circle based on target intercept changes, the Steering Dot rate of change is adjusted.
2. **Relative Target Range.** Relative range of the target on the NIRD circle in relation to the missile range cues.
3. **Minimum Launch Range ( $R_{MIN}$ ).** Computed minimum launch range for the priority AIM-120.
4. **No Escape Range ( $R_{NE}$ ).** This is the calculated range at which the target will remain within maximum range even if the target turns instantaneously 180° aspect.
5. **Maximum Launch Range ( $R_{MAX}$ ).** Computed maximum range of the missile against a locked, non-maneuvering target.

6. **Target Aspect Angle Pointer.** Displays relative target heading.
7. **Steering Dot.** The Steering Dot in conjunction with the NIRD/ASE circle indicates lead angle steering to the locked target. Fly to place the Steering Dot inside the NIRD/ASE circle to satisfy lead angle computations. The Steering Dot will flash when within 15° of the radar's azimuth limit and when within 5° of the radar's elevation limit.
8. **AIM-120 Time to Active (ACT) / Time to Go (TTG).** Displays the calculated time in seconds for missile to be in range to track the target with its onboard seeker. Upon reaching ACT, this field changes to Time to Go until it is estimated the AIM-120 will reach the target.
9. **Target Designator (TD).** This box/diamond indicates the line of sight between the aircraft and the locked target. If the locked target is outside the HUD field of view, the TD box flashes.

If radar tracking on the target is lost, the TD box will be hashed to indicate the radar is in memory (MEM) mode and extrapolating its position to reacquire it.

If the target is identified as hostile, the box is rotated 45° to create a diamond symbol.

Not pictured:

- **RAERO.** Maximum aerodynamic range is displayed when the launch aircraft has more velocity than the missile, but the missile is still capable of a 5-g maneuver. This appears as a diamond symbol on the outside of the NIRD circle (not pictured).
- **Breakaway X.** Displayed when range to target is less than Minimum Range Cue.
- **Shoot Cue.** The word SHOOT is displayed above the TD box when AIM-120 shoot conditions are satisfied. If the locked target is in the no escape zone ( $R_{NE}$ ), the Shoot Cue flashes.
- **Target Locator Line.** When the target is outside the HUD field of view, the Target Locator Line appears and points in the direction of the target. Additionally, degrees to the target is displayed next to the arrow.

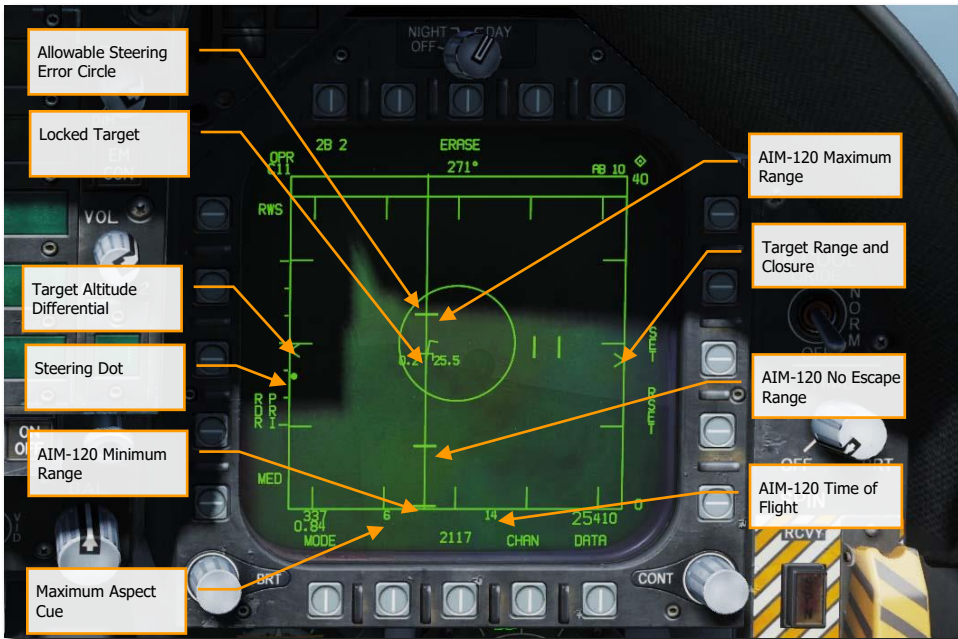

Figure 156. AIM-120 Radar with Radar Lock, Pre-Launch

**Target Range and Closure Indication.** The range of the target is indicated in reference to the range scale and selected radar range display setting. Left of the caret, closure velocity ( $V_c$ ) is indicated.

**AIM-120 Minimum Range.** Calculated minimum launch distance.

**AIM-120 No Escape Range.** Calculated no escape distance.

**AIM-120 Maximum Range.** Calculated maximum range distance.

**Locked Target.** Around the L&S star symbol, target information is displayed that includes Acceleration Vector, Target Aspect Angle Pointer, Tracked Target indication, Target Altitude in thousands of feet, and Target Airspeed in Mach.

The Acceleration Vector is displayed in the direction of acceleration, perpendicular to the target heading vector when the target exceeds 3 g. The length of the Acceleration Vector lengthens with greater target g.

**Allowable Steering Error Circle.** Static ASE circle for the AIM-120. Fly to place the steering dot within the ASE circle to increase probability of a kill.

**Target Altitude Differential.** Displays the difference in altitude between the target and ownship in thousands of feet.

**Maximum Aspect Cue.** This cue can range from 1 to 18 and indicates shot quality. The higher the number, the great probability of missile intercept.

**AIM-120 Time of Flight.** This indicates the estimated Time of Flight for the un-launched missile to reach the locked target. Once the missile has been launched, the missile fly-out indication displays missile time to go.

**Steering Dot.** This small, solid dot provides a reference to required target lead based on the ASE circle. Flying to place the Steering Dot inside the ASE circle allows the AIM-120 to pull less g at launch and thereby have more energy to intercept the target.

Not pictured above:

- **Shoot and Lost Cue.** When the target is within  $R_{MAX}$  range, the Shoot Cue appears as solid. When the target range is within  $R_{NE}$ , the Shoot Cue flashes.

## AIM-120, Radar Tracking Post-Launch

Upon launch of an AIM-120 against a designated target, additional information becomes available on the HUD and radar as described below.



Figure 157. AIM-120 Radar Tracking, Post Launch HUD

**AIM-120 Time to Go (TTG).** Displays the calculated time in seconds for missile to be in range to track the target with its onboard seeker. Upon reaching ACT, this field changes to Time to Go until it is estimated the AIM-120 will reach the target.

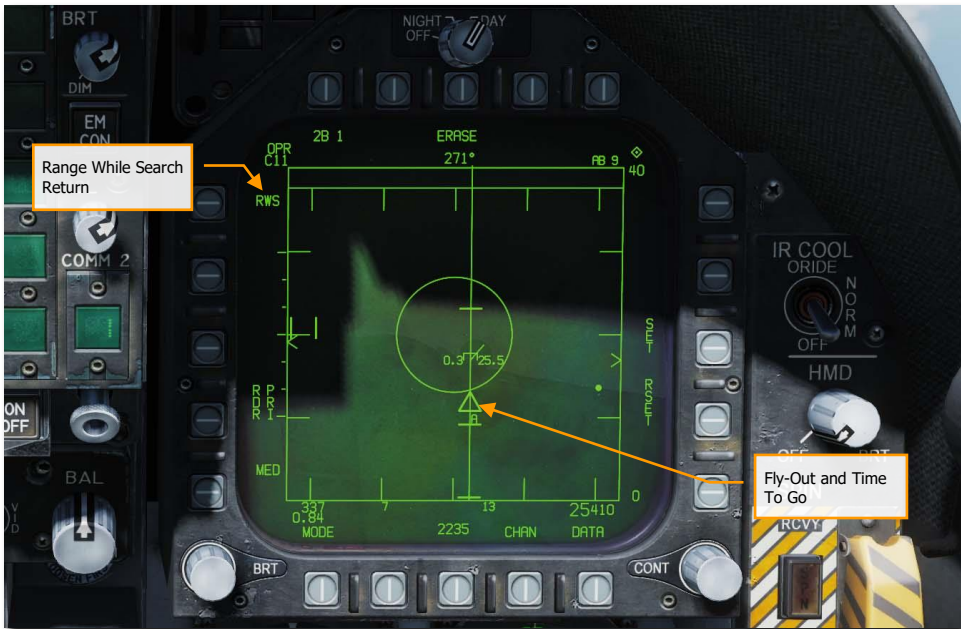

Figure 158. AIM-120 Radar Tracking, Post Launch HUD

**Fly-Out and Time to Go.** Graphically displays the fly-out of the AIM-120 and the estimated Time to Go (TTG) until target intercept. This appears as a pyramid on the Azimuth Steering Line to the target. Prior to AIM-120 seeker activation, the time is seconds until activation is displayed. Upon seeker activation, an "A" is displayed.

**Range While Search Return.** Pressing the RWS on pushbutton 5 discontinues the Single Target Track (STT) and returns the radar to the RWS mode. You may also exit the lock to search by pressing the Undesignate button [S].

Not pictured:

- **Memory Mode indication and Memory Track Time.** If the radar loses track on the target, it will automatically enter memory (MEM) mode. During this period, the radar will attempt to reacquire the target and the amount of time the radar is in memory mode is displayed in seconds to the right.

# AIR-TO-GROUND EMPLOYMENT



USAF photo  
by SSgt Preston Webb

## AIR-TO-GROUND MASTER MODE

The F/A-18C can employ both guided and unguided weapons, as well as its internal gun. It has the capability to locate and track targets using the onboard radar, ATFLIR, targeting pod, and JHMCS cueing.

To place the F/A-18C in A/G mode, first press the A/G button from the Master Mode from the left instrument panel and there must be no weight on wheels. If the Master Arm switch is placed in the SAFE position, weapon release is inhibited, and the SIM training mode is available. When in the ARM position, weapons may be released normally.



Figure 159. A/G Master Mode Select



# AIR-TO-GROUND MARKPOINTS

In both Nav and air-to-ground mode, the F/A-18C can designate markpoints, locations on the ground which are remembered for later use. Markpoints can be used to designate locations or targets of interest and are effectively the same as waypoints: they can be navigated to or designated for weapons employment.

The F/A-18C can store up to nine markpoints, labeled MK1 through MK9. MK1 is used following power-on with weight on wheels, then each subsequent markpoint designation is stored in MK2, MK3, and so on. After MK9 is stored, the next markpoint designation is written to MK1, overwriting the previously stored value.

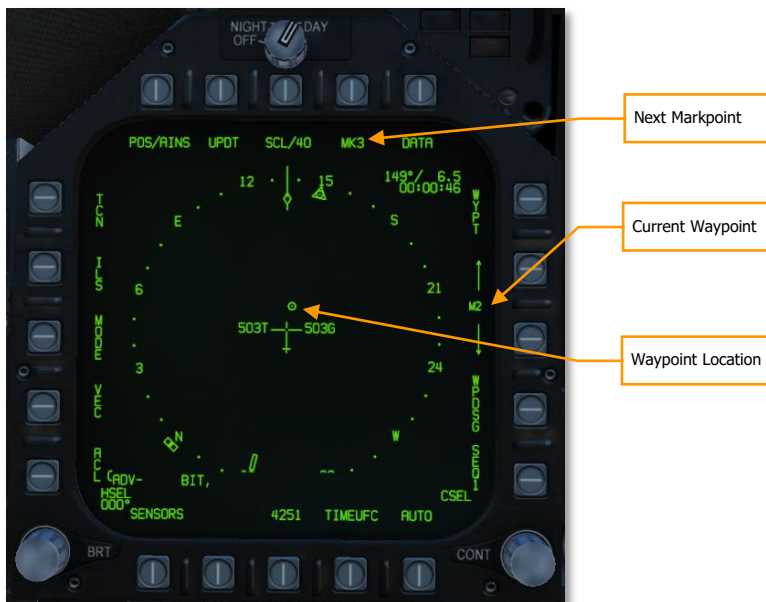

**Next Markpoint.** Displays the next markpoint to be stored. Pressing this pushbutton stores a markpoint.

**Current Waypoint.** Shows the current waypoint. The up and down arrows cycle through waypoints. Markpoints are placed in sequence after the last waypoint, WP59. Cycling down from WP0 selects MK9 and cycling up from WP59 selects MK1.

## Designating Markpoints

To designate a markpoint, press PB8 (labeled "MK#") on the HSI format. The location will be stored in the markpoint number that was previously shown adjacent the pushbutton, and the markpoint number will increment by one.

The current target designation will determine what type of markpoint is stored:

**Overfly markpoint:** To create an overfly markpoint (a markpoint at the current aircraft location), ensure that there is no target designation on any format.

**Waypoint markpoint:** To create a markpoint at the location of a waypoint, designate the waypoint by selecting it and then boxing WYPT (PB11) on the HSI format.

**Air-to-ground radar markpoint:** To create a markpoint using the air-to-ground radar, slew the radar cursor to the location you wish to mark, then press the TDC to designate it. On the HSI format, press the MK# pushbutton to create a markpoint at that location. You can then press the pinky button to undesignate the radar target.

**Targeting pod markpoint:** To create a markpoint using the targeting pod, slew the pod LOS to the location you wish to mark, then press the TDC to designate it. On the HSI format, press the MK# pushbutton to create a markpoint at that location. You can then press the pinky button to undesignate the FLIR target.

## Getting Markpoint Coordinates

You may need to relay the coordinates of a markpoint to other players, e.g., if you locate and mark a target that you need assistance destroying.

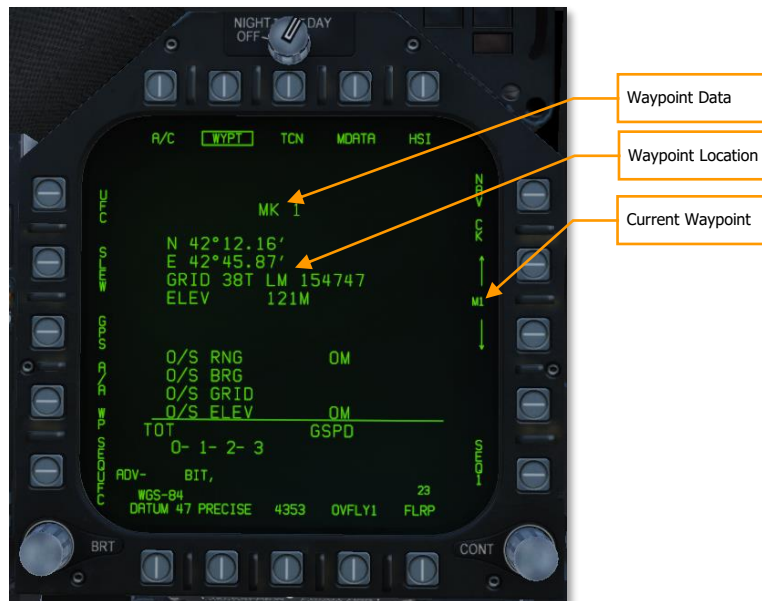

You can retrieve markpoint coordinates the same way you retrieve waypoint coordinates. From the HSI format, press PB10 (labeled DATA) to navigate to the data sub-view. Ensure that PB7 (labeled WYPT) is boxed and use the up/down arrows (PB12 and 13) to navigate to the markpoint. (Remember, the markpoints are stored after WP59 and before WPO.)

Once the proper markpoint is selected, the latitude, longitude, MGRS coordinates, and elevation will be shown on the data page. You can box PRECISE (PB19) to display more precise coordinate data.

## Navigating to Markpoints

Markpoints can be navigated to just like waypoints. (However, you cannot add markpoints to a waypoint sequence.)

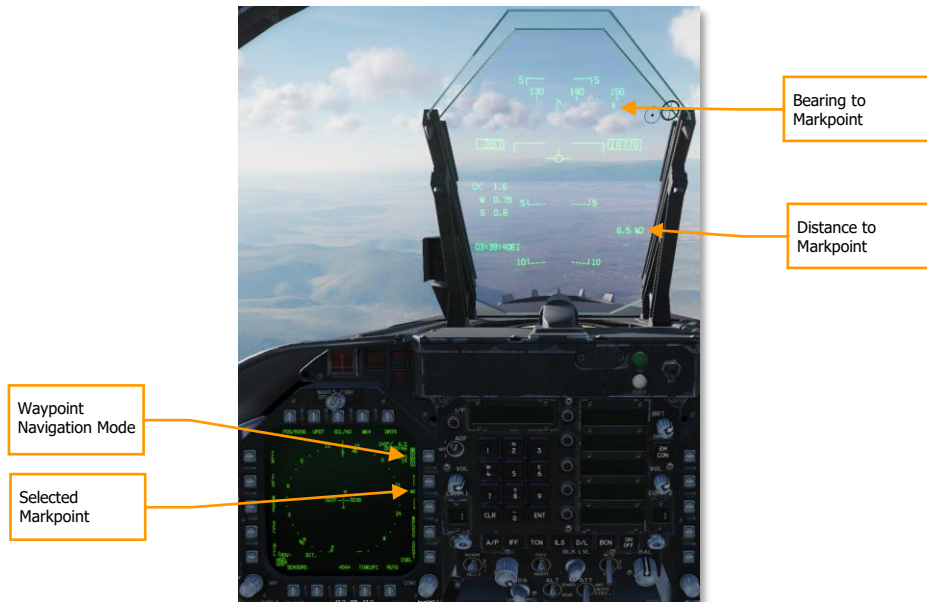

To navigate to a markpoint, select it from the HSI format using the up/down arrows adjacent PB12 and 13. (Remember, the markpoints are stored after WP59 and before WP0.) When the desired markpoint is selected, press PB11 to box WYPT and set the markpoint as the navigation destination.

The upper-left datablock on the HSI will show your bearing, distance, and time to the markpoint, and the HUD will show your bearing to the markpoint along the heading tape, and the distance to the markpoint on the lower-left datablock. If you wish to fly a specific course to the markpoint, use the CSEL switch to set the desired inbound course. See Waypoint Navigation for more information.

# AIR-TO-GROUND SMS BOMBING PAGE

Upon selection of the A/G master mode, the A/G SMS page is displayed on the left DDI. Based on the priority weapon, the information on the SMS page can vary. For conventional bombs, the SMS commonly includes the following:



Figure 160. A/G Conventional Bombing SMS Page

1. **Weapon Select Options.** The top row of pushbuttons is used to select the desired A/G weapon. One option is provided for each displayed weapon type (maximum 5). An abbreviation of the selected weapon type is displayed below the pushbutton. When a weapon is selected, the abbreviation is boxed. Pressing the button again will unselect the weapon. If the A/G weapon is in a release condition, "RDY" is displayed below the weapon box. Otherwise, an "X" is displayed through the weapon box.
2. **Wingform Display.** The wingform display provides the number, type, and status of all stores loaded on the aircraft's weapon stations. A weapons rack is indicated as a diamond symbol, and the number below indicates the number of weapons loaded on the rack / station. Various indications can be displayed below the number of weapons numeric to indicate weapon status, such as: RDY (ready), STBY (standby), selected (SEL), LKD (locked) and ULK (unlocked). A box is displayed around the weapon abbreviation on the wingform when it is selected as the priority weapon. The gun rounds remaining is indicated at the top of the wingform (578 being a full load and XXX when empty).

3. **Delivery Program Options.** Based on the selected weapon, it may have different delivery options that can be adjusted using these pushbuttons along the left side of the display. Pressing a program button then displays the possible settings for that program option. This will be discussed ahead in the A/G Stores Programming section of this guide.
4. **Program Data.** This area of the display is provided to show release settings as set in the Delivery Program Options for conventional and laser-guided bombs. When a Program contains invalid data, the PROG and number will have an "X" through it.
5. **Program Select Option (PROG).** This option is only available for conventional and laser-guided bombs and allows the selection of five release programs for each weapon type. Successive presses of the PROG pushbutton cycle through the programs. The selected program is displayed at the top of the Program Data. Any changes to the program data for a program are saved and can be retried later when the program is re-selected.
6. **Tone Option.** Cycles between TONE1, TONE2, and unboxed. When boxed, a tone is played over the COMM1 (TONE1) or COMM2 (TONE2) radio whenever the Master Arm is on and the Weapon Release button is pressed.
7. **SIM Mode Option.** When the Master Arm Switch is set to SAFE, the SIM option becomes available. SIM mode allows simulated SMS page and HUD operations, but all weapon release functions are inhibited. When in SIM mode, SIM replaces the ARM/SAFE indication on the A/G SMS page.
8. **Up-Front Control (UFC) Option.** This option is displayed when the selected weapon can have data entered for it using the UFC like weapon release quantity, interval, etc.
9. **Station Step Option (STEP).** The option is provided when the Stores page determines that the weapons of the selected type are available for release on more than one weapon station. Each successive press of the STEP push tile changes the selected weapon to the next weapon station.
10. **Gun Option.** The GUN option is used to select the gun as the priority A/G weapon or enable the gun to be used in conjunction with delivery of another weapon (HOT GUN).
11. **Master Arm Status.** This displays the status of the Master Arm switch, and can be either ARM, SAFE or SIM.

## A/G Stores Programming

Programming A/G stores can be done from either A/G or NAV master modes. Up to five delivery programs can be created for each A/G weapon except the gun. Using the PROG pushbutton, you can cycle through the programs with successive presses. There are two primary aspects of creating a delivery program for a weapon: The Delivery Program Options along the left side of the SMS page and the UFC.

### *Delivery Program Options*

After selecting a Delivery Program Option, the left side of the SMS page will change the pushbuttons to show the possible selections for the selected option:

- MODE (Delivery Mode)
  - AUTO (Automatic)
  - FD (Flight Director) (N/I)
  - CCIP (Continuously Computed Impact Point)
  - MAN (Manual Release)
- MFUZ (Mechanical Fuse)
  - OFF
  - NOSE (Nose Fuse Only)
  - TAIL (Tail Fuse Only)
  - NT (Nose and Tail)
- EFUZ (Electronic Fuse)
  - OFF
  - VT (Variable Time or Proximity)
  - INST (Instantaneous)
  - DLY1 (Delay 1)
  - DLY2 (Delay 2)
- DRAG
  - FF (Free Fall)
  - RET (Retarded)

**Bomb Fuze Settings.** Different types of bombs require different MFUZ and EFUZ settings. In the current early access, the following should be used:

General Purpose Bombs (Mk-80 series):

- MFUZE = NOSE
- EFUZ = INST

Canister Munitions (CBU and Mk-20)

- MFUZE = VT
- HT to 1500
- EFUZ = INST

Laser and GPS Guided (GBU series)

- MFUZE = OFF
- EFUZ = INST or DLY1

**HT Option.** The Mk-20, CBU-99, and CBU-100 canister weapons default to using FMU-140 fuses. This is a fixed-setting fuse with an arming time of 1.2 seconds after release.

When MFUZ is set to VT though, the HT (height) setting is available. Successive presses of the HT pushbutton cycle through the possible Height of Burst (HOB) settings.

### UFC Options

When the UFC pushbutton is selected from the right side the SMS page, bomb program parameters are displayed on the UFC.



Figure 161. UFC Bomb Settings

By pressing an Option Select Key on the UFC, you can select the bomb program parameter to enter. The selected parameter is indicated by the colon (":") next to the indicator of:

- **Quantity (QTY).** Number of bombs to release, ranging from 1 to 30. When more than one bomb is selected, you must hold the Weapon Release Button down until all bombs in the salvo are released.
- **Multiples (MULT).** Number of bombs to be released simultaneously from the weapon stations in each salvo
- **Interval (INT).** The ground impact spacing in feet when in AUTO, FD, and CCIP modes, but milliseconds when on MAN mode.

After each value is entered using the UFC keypad, the ENTER button on the UFC must be pressed to save the value to the program. Once saved, the value is displayed on the Program Data for the selected program (1 to 5).

Another possible UFC option is the Reticle (RTCL) option. When displayed, you may enter a value in milliradians for manual delivery release. This in turn adjust the bombing reticle on the HUD. This will be discussed in the Manual Bombing section of this guide.

# AIR-TO-GROUND BOMBING HUD

The HUD has three weapon delivery modes:

- Continuously Computed Impact Point (CCIP)
- Automatic (AUTO)
- Manual (MAN)

## Unguided CCIP Bombing Mode HUD

Mission Practice: CCIP Bombing

### *How to Bomb Using CCIP Mode*

1. Master Mode switch to A/G
2. Select a conventional A/G bomb from the SMS page
3. Set MODE option to CCIP
4. Fly to place the CCIP Bombing Cross over the target while keeping the Velocity Vector above the Pullup Cue
5. Press and hold the Weapon Release button

The CCIP mode is a computed visual delivery mode with manual weapon release. This mode allows a high degree of flexibility since the point on the ground at which the weapon will impact is continuously indicated by a CCIP Bombing Cross on the HUD. No target designation is required. In essence, place the thing on the thing and drop the bomb.

To use, fly to place the CCIP bombing cross over the intended target and hold the Weapon Release Button down (pickle button). A Displayed Impact Line (DIL) is also on the HUD between the CCIP bombing cross and the velocity vector. The pickle button must be held down until all bombs have been released as part of the program.

After bomb release, the Time to Impact (TTI) is presented on the HUD as the Time of Fall (TOF).

If the CCIP impact point does not lay within the HUD field of view, the CCIP Reflected Cue is shown as a short, horizontal line on the DIL instead of the CCIP Bombing Cross. The cue is displaced to the same distance above the bottom of the DIL as the computed position of the CCIP Bombing Cross is below the HUD limit.

Elements of the CCIP Bombing HUD include:



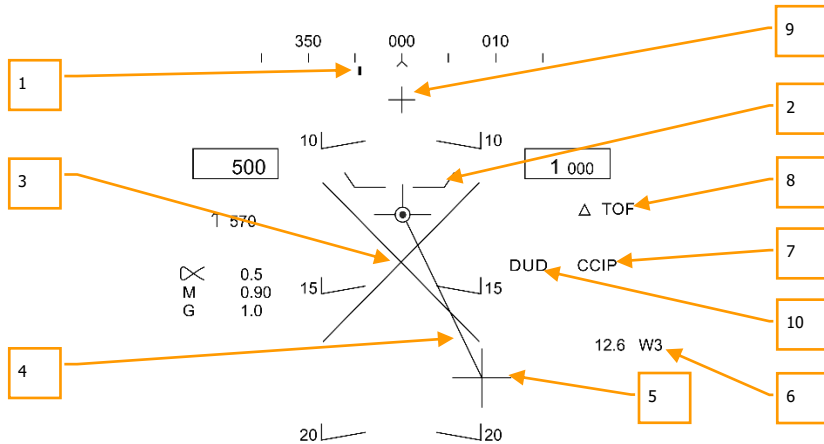

Figure 162. CCIP Bombing HUD

1. **Steering Point** (Command Heading). this pointer on the heading scale provides steering to the selected waypoint or TACAN station.
2. **Pullup Cue.** The distance between the Pull Up Cue and the Velocity Vector provides a relative indication of a safe altitude for delivering the selected weapon. For a safe weapon release, the Pull Up Cue should always be below the Velocity Vector. The Pull Up Cue also provides minimum altitude release for cluster munitions.
3. **Breakaway X.** The flashing Breakaway X will appear on the HUD when a ground collision is imminent, or the DUD cue is visible.
4. **Displayed Impact Line** (DIL). The line between the CCIP Bomb Cross and the Velocity Vector represents the bomb fall line.
5. **CCIP Bomb Cross.** This cross represents the impact point of the bomb(s).
6. **Waypoint and Distance.** Selected waypoint number and distance to the selected waypoint in miles. If in TACAN steering, this would be in relation to the selected TACAN station.
7. **Mode Indication.** The selected bombing mode. CCIP in this situation.
8. **Time of Fall.** Estimated time until weapon impact of the last weapon released. This is indicated in seconds with a "TOF" suffix.
9. **Hot Gun Cue.** Displayed when GUN has been selected from the SMS page. The gun can be fired while in CCIP using the trigger.
10. **DUD Bomb Cue.** If a canister weapon is selected and the bomb would impact before it would be armed, the DUD Bomb Cue is displayed. The DUD cue will also be displayed if an invalid fuze setting has been selected from the MFUZE and EFUZE settings:
  - General Purpose Bombs (Mk-80 series):
    - MFUZE = NOSE
    - EFUZE = INST
  - Canister Munitions (CBU and Mk-20)

- MFUZE = VT
    - HT to 1500
    - EFUZ = INST
  - Laser and GPS Guided (GBU series)
    - MFUZE = OFF
    - EFUZ = INST or DLY1
11. **CCIP Target Designation Option:** When in CCIP mode and the TDC is assigned to the HUD, and the CCIP Bombing Cross is within the HUD field of view, pressing the TDC displays the TD on the HUD, which can be slewed within the HUD field of view using the TDC. The TD will initialize on the Velocity Vector or at 7.5°, whichever pitch angle is greater. When the TDC button is released, AUTO bombing mode is entered based on the new target location.

## Automatic (AUTO) Bombing Mode HUD

### Mission Practice: F/A-18C Conventional Bombing

The AUTO mode provides computed, automatic release of bombs. It computes release solutions for dive, dive toss, level, and low angle lofts up to 45°. This mode requires a ground designation point from which to build the bombing solution. Command steering is provided to the appropriate weapon release point and the weapon will release automatically at the proper time such that the weapons hit the target.

To calculate a bombing solution in AUTO mode, a target first must be designated. This can be done by:

- Flying to place the HUD reticle pipper over the target and designate it with the TDC button.
- Designating a waypoint location as the target as set on the HSI using the WPDSG option.

#### *How to Bomb in AUTO Mode Using the HUD*

1. Master Mode switch to A/G
2. Select conventional A/G bomb from the SMS page
3. Set MODE option to AUTO
4. Assign TDC to the HUD (Sensor Control Switch forward)
5. Fly to place the Reticle over the target and then designate the target by pressing the TDC switch
6. While flying to keep the Velocity Vector above the Pullup Cue, keep the Velocity Vector over the Azimuth Steering Line (ASL), and hold the Weapon Release button down when the Release Cue appears on the HUD
7. Release the Weapon Release Button once all bombs in the pass have been released

#### *AUTO HUD Designation*

The Mission Computer (MC) provides an Azimuth Steering Line (ASL) to provide steering to the designated target. Designation is accomplished pressing and holding the Weapon Release Button when the HUD Reticle is over the target. By placing the Velocity Vector on the ASL and holding down the Weapon Release Button, the weapon will release at the proper time and account for wind.

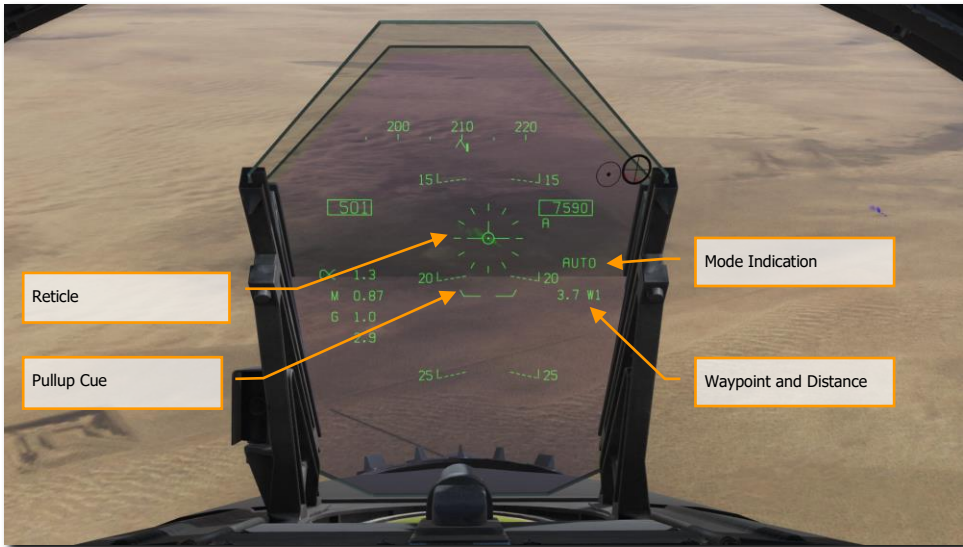

Figure 163. AUTO Bombing HUD, No Designation



Figure 164. AUTO Bombing HUD, No Designation <7.5° Dive Angle

**Reticle.** This Reticle consists of tic marks in 50-mil diameter circle with a pipper in the center. The TDC must be assigned to the HUD (Sensor Control Switch forward) for the reticle to be visible on the HUD. The Reticle serves

as a steering reference for weapon delivery by having the pilot fly the aircraft to place the pipper of the Reticle over the intended target and then designating it.

**Pullup Cue.** The distance between the Pull Up Cue and the Velocity Vector provides a relative indication of a safe altitude for delivering the selected weapon. For a safe weapon release, the Pull Up Cue should always be below the Velocity Vector. The Pull Up Cue also provides minimum altitude release for cluster munitions. When the Velocity Vector is below the Pullup Cue, the Breakaway X is displayed on the HUD.

**Mode Indication.** Indication of the selected bombing mode from the Stores page.

**Waypoint and Distance.** The selected waypoint number and the distance to the waypoint in miles. If the target is co-located with the waypoint, this will also be the Target Distance. This may also be in reference to TACAN steering.

**Hot Gun Cue.** Displayed when GUN has been selected from the SMS page. The gun can be fired while in AUTO mode using the trigger.

**Displayed Impact Line (DIL).** The flashing, dashed DIL is displayed on the HUD when dive angle is greater than 7.5°. The DIL extends from the Vertical Velocity indicator to the center of the Reticle.

### *AUTO Waypoint Designation*

#### Mission Practice: F/A-18C Conventional Bombing

The Mission Computer (MC) provides an Azimuth Steering Line (ASL) to provide steering to the designated target based on a designated waypoint. Designation is accomplished by selecting a waypoint on the HSI and selecting the Waypoint Designation (WPDSG) option on pushbutton 18. This will turn set the selecting waypoint as a target (TGT) waypoint from which the AUTO bomb delivery is calculated.

#### *How to Bomb in AUTO Mode Using a Target Waypoint*

1. Master Mode switch to A/G
2. Select conventional A/G bomb from the SMS page
3. Set MODE option to AUTO
4. Select the waypoint at the desired target location
5. Select WPDSG from HSI to set the waypoint as the TGT
6. While flying to keep the Velocity Vector above the Pullup Cue, keep the Velocity Vector over the Azimuth Steering Line (ASL), and hold the Weapon Release button down when the Release Cue appears on the HUD
7. Release the Weapon Release Button once all bombs in the pass have been released



Figure 165. AUTO Bombing, No Designation



Figure 166. AUTO Bombing, Waypoint Designated as Target (TGT)

Once a waypoint is designated as a target (TGT), the HUD provides steering directions toward it.

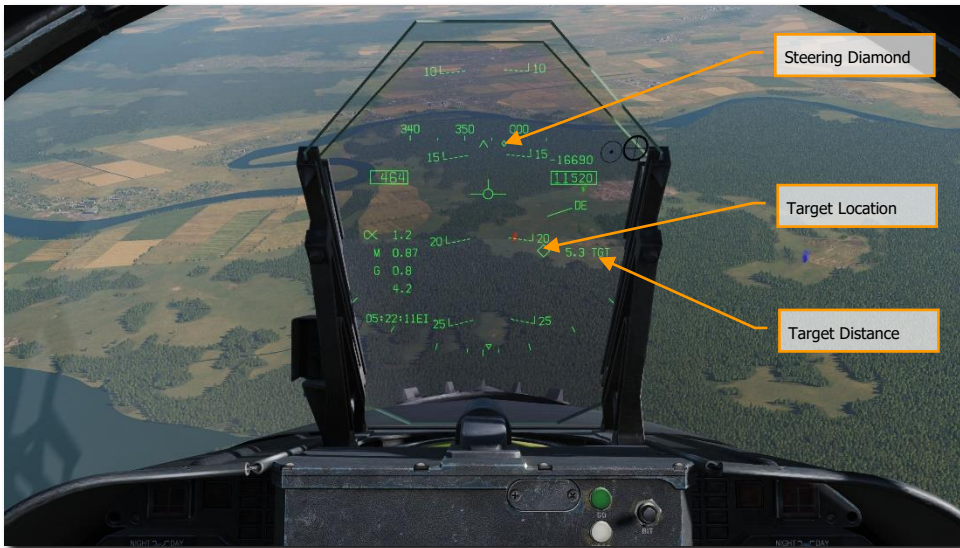

Figure 167. AUTO Bombing HUD

**Steering Diamond.** Along the heading tape, this diamond indicates the steering direction toward the target location. When flying directly toward the target, this diamond will be in the center of the heading tape.

**Target Location.** A diamond symbol marks the line-of-sight location to the target. When the location is outside the HUD field of view, this diamond is clamped to the side of the HUD closest to the target and flashes. Note that the location of the target also accounts for the entered elevation of the waypoint from which the target is created.

**Target Distance.** The distance to the target is indicated at the range in nautical miles.

### *AUTO Bombing Delivery*

Once the target is designated using either the HUD or a waypoint and the SMS page is set for AUTO delivery, the Azimuth Steering Line (ASL) is displayed on the HUD and provides steering direction to the target as indicated by the Steering Pointer on the Heading Scale. When within the HUD field of view, the target will also be marked with a diamond Target Designator that denotes the target's line of sight location. By flying the aircraft to keep the Velocity Vector on the ASL, the aircraft will assume the correct azimuth steering to satisfy the bombing solution. By flying to maintain the Velocity Vector over the Pullup Cue, adequate release altitude is also assured to avoid weapon fragmentation and weapon fuzing.

When the target diamond is dashed, the TDC cursor can be used to move the target location.

If a canister weapon is selected and the bomb would impact before it would be armed, the DUD Bomb Cue is displayed.



Figure 168. AUTO Bombing HUD, Designated

**Steering Pointer.** Once a target has been designated, the cue changes from a line indicating navigation steering (waypoint or TACAN), to a diamond that indicates steering to the designated target.

**Release Cue.** This small, horizontal line centered on the ASL is displayed when the target is designated, and it indicates both in-range and release cue anticipation indicator. For high drag bombs, the cue is displayed 5 seconds before release.

**Azimuth Steering Line (ASL).** The ASL is always perpendicular to the horizon and provides an azimuth steering reference to the designated target with respect to the Velocity Vector. The ASL is removed from the HUD when the target command steering is greater than 90°.

**Target Designator (TD).** This symbol shows the line of sight to the designated target. The symbol is 9 miles long on each side and has a pipper in the center when the TDC is assigned to the HUD. Using the TDC, the TD can be moved within the HUD field of view (useful when refining a target designation). If the TD is outside the HUD field of view, it is clamped to the nearest side and flashes. The TD is removed from the HUD when the target command steering is greater than 90°.

**Time to Go / Time to Impact.** Upon target designation, the estimated time to release is indicated in seconds with an "REL" suffix. After the bomb(s) is released, this field indicates the estimated Time to Impact and is indicated in seconds of the last weapon released with a "TTI" suffix.

**Target Range.** When the target is designated, the range to the target is indicated in miles.

Note that when the target is not within the HUD field of view, a target arrow points in the direction of the target and the number of degrees to the target is displayed next to the arrow.



## Manual (MAN) Bombing Mode HUD

### Mission Practice: F/A-18C MAN (Manual) Bombing

Manual mode is a backup mode for visual delivery. From the A/G SMS page with MAN selected as the delivery mode, the UFC function allows the pilot to adjust the HUD reticle position in mils. By understanding the bombing table data for a weapon (release angle, altitude, and airspeed), the manual mode can be an effective means to place bombs on target.

#### *How to Bomb Using MAN Mode*

1. Master Mode switch to A/G
2. Select weapon
3. Select conventional A/G bomb from SMS page
4. Set MODE option to MAN
5. Select the UFC Option Select Button on the A/G SMS page and enter the desired mils setting on the UFC using the keypad. When complete, press the ENTER button on the UFC
6. Fly to place the Reticle over the target-based bombing table data

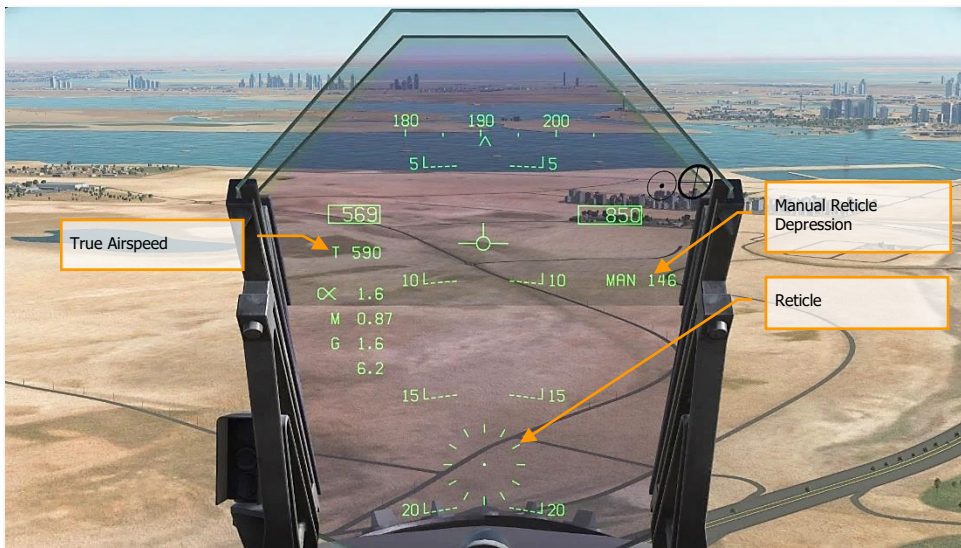

Figure 169. MAN (Manual) Bombing HUD

**Manual Reticle Depression.** Depression of the Reticle in mils based on the UFC input.

**Reticle.** Fixed Reticle at static position on the HUD based on the manual mils setting.

**True Airspeed.** When in MAN mode, True Air Speed (T) is displayed below the indicated airspeed box.

## High Drag (HD) Bomb Delivery

The F/A-18C has the option to delivery high drag bombs that either use a ballute chute or fold-out brakes. This allows the bomb to fall well behind the aircraft when dropped at low-altitudes and fast airspeeds. In addition to the high-drag option, these bombs also have "slick" options that allow them to behave as standard free-fall bombs. The F/A-18C's high drag bombs include:

- Mk-82 Snake Eye, that is a Mk-82, 500-pound class bomb that has the option for four, fold-out airbrakes to slow the weapon. The SMS code is 82XT.
- MK-82 with BSU-49 ballute is a Mk-82, 500-pound class bomb that uses an inflatable bag that retards the weapon. It SMS code is 82YT.

High drag weapons can be delivered in CCIP, AUTO, and MAN modes.

### *SMS Set Up*

Upon selecting a high drag bomb:

1. Set delivery MODE
2. Set MFUZE to NOSE
3. Set EFUZ to INST
4. Set DRAG to FF for free fall or RET for high drag

When DRAG is set to RET, guidelines for an accurate delivery are as follows:

- Ensure that aircraft barometric pressure altimeter match the mission
- Level flight between 300 to 500 feet AGL
- Maintain flight path marker on or just above the horizon line on the HUD. Letting it dip below the horizon line will result in a Break X.
- Airspeed above 450 knots

## JHMCS AIR-TO-GROUND MODE

The Joint Helmet-Mounted Cueing System can be used in air-to-ground mode to visually designate targets within the pilot's line-of-sight. To use the JHMCS in air-to-ground mode, first put the aircraft in A/G Master Mode and verify that the HMD knob is turned up. Then press Castle Switch Forward to move TDC priority to the HMD and HUD.

When the JHMCS is on, Castle Switch forward assigns the TDC to either the HMD or the HUD. TDC assignment then automatically switches between the HMD and the HUD until the TDC is assigned to an MFD. When the pilot LOS is within the HMD blanking area (in other words, generally looking forward towards the HUD), TDC assignment moves to the HUD. When the pilot LOS is outside of the HMD blanking area, TDC assignment moves to the HMD. This is true regardless of whether HMD blanking is turned on or off.

When the TDC is assigned to the HUD, the TVV appears with a dot in the center:



When the pilot's LOS moves away from the HUD, TDC priority jumps to the HMD, and an aiming reticle appears on the HMD:



Figure 170. JHMCS A/G Mode, No Designation

The aiming reticle appears if a) the aircraft is in A/G Master Mode, b) the JHMCS is powered on, c) the pilot LOS is outside the HMD blanking area, and d) there is no current designation.

With the aiming reticle visible, pressing TDC Designate creates a designation at pilot line-of-sight. The mission computer calculates best altitude above target (BAAT) to place the TDC on the surface of the earth.

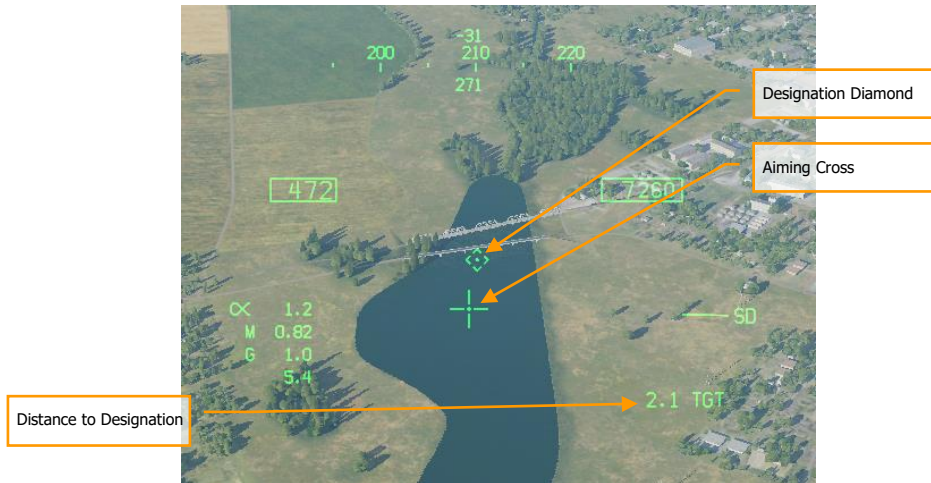

Figure 171. JHMCS A/G Mode, Designation

A designation diamond will appear on the surface at the designated location. If the targeting pod is active, pod LOS will automatically slew to the designation LOS. The aiming reticle will change to a smaller cross; a dot will appear in the center of the cross if the HMD still has TDC priority.

The designation diamond will have a segmented outline if no-action slew is available; in other words, if the pilot can refine the designation using the TDC immediately. If the designation cannot be slewed (e.g., the FLIR is in a track mode), the diamond will appear solid.

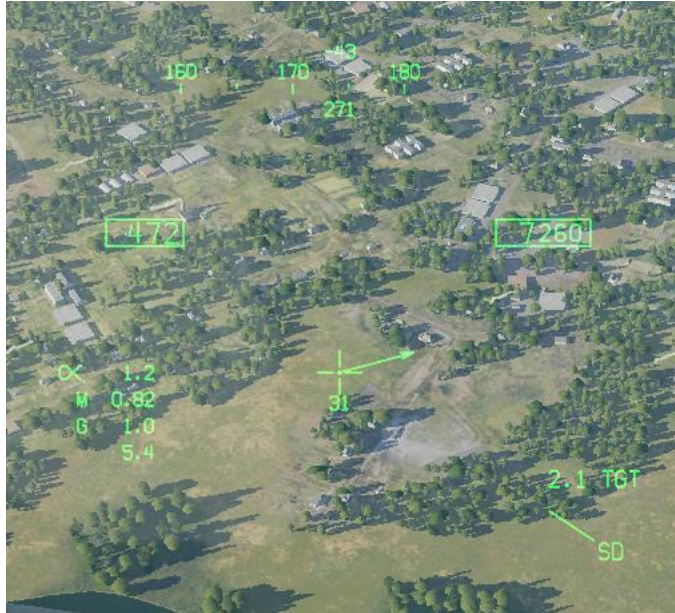

Figure 172. JHMCS A/G Mode, Off-View Designation

If the designation moves out of the HMD field of view, the aiming cross will gain a target locator line (TLL) pointing in the direction of the designation. A number will appear below the aiming cross indicating the angle between HMD LOS and the designation, in degrees.

# LASER-GUIDED BOMBING

## Weapons Practice: Paveway II Laser Guided Bombs

Delivery of laser-guided bombs can be conducted in CCIP, AUTO, and MAN modes, but AUTO mode is preferable as it allows delivery while in level flight. Laser-guided bombs should be released at greater than 8,000 feet AGL to give enough time for laser designation capture and guidance.

Two general types of laser-guided bomb units (GBU) can be loaded on the F/A-18C:

- Paveway II series: GBU-10, GBU-12, and GBU-16
- Paveway III series: GBU-24B/B

Both Paveway series have unique SMS and HUD symbology.

### *How to Use Laser-Guided Bombs in AUTO Mode*

1. Master Mode switch to A/G
2. Select weapon
3. Select laser-guided bomb from SMS page
4. Set MODE option to AUTO
5. Set MFUZ to OFF and EFUZ to INST
6. Create TGT point to which bomb will guide
7. Set laser code of bomb to match designation code
8. Align bomb fall line with target bearing and drop bomb when release cue passes through the velocity vector

## Paveway II Series

### *Loading*

SMS Codes:

- GBU-10: 84LG
- GBU-12: 82LG
- GBU-16: 83LG

Loading:

- A single GBU-10 can be loaded on stations 2, 3, 7, and 8 on a BRU-32.
- A single GBU-12 and 16 can be loaded on stations 2, 3, 7, and 8 on a BRU-32.
- Dual GBU-12s can be loaded on stations 2, 3, 7, and 8 on a BRU-33.

## SMS Page

Paveway II series bombs are displayed on the wingform as conventional bombs are. The only difference is that a four-digit laser code is displayed below the weapon code. All Paveway II series bombs show the same code if a Paveway II series bomb is not first selected. If a Paveway II series bomb is selected, the code is just be applied to the priority station bomb. This allows you to set separate laser codes for each bomb.

If an LGB is detected as being loaded on the aircraft, the CODE pushbutton will be present on the SMS page at pushbutton 1.

The default laser code is XXXX. To change the code, the CODE legend at pushbutton 1 is pressed when a Paveway II series bomb is already selected. Upon doing so, the bottom Option Select Window shows CODE, and the keypad can be used to enter a four-digit code. Once CODE is colonized, this code should match the designation from a JTAC, targeting pod, or another laser designation source. Once the UFC ENT button is pressed, the code is saved to the SMS and is displayed below one or all Paveway II series bomb.

As with unguided bombs in AUTO, CCIP, and MAN modes, the UFC option can be used to set quantity, interval, and multiple values if desired.



Figure 173. LGB UFC CODE

## HUD

For Paveway II series bombs, both the AUTO and MAN HUD modes are identical to conventional delivery. The additional data seen in the image below appears to be targeting pod related.

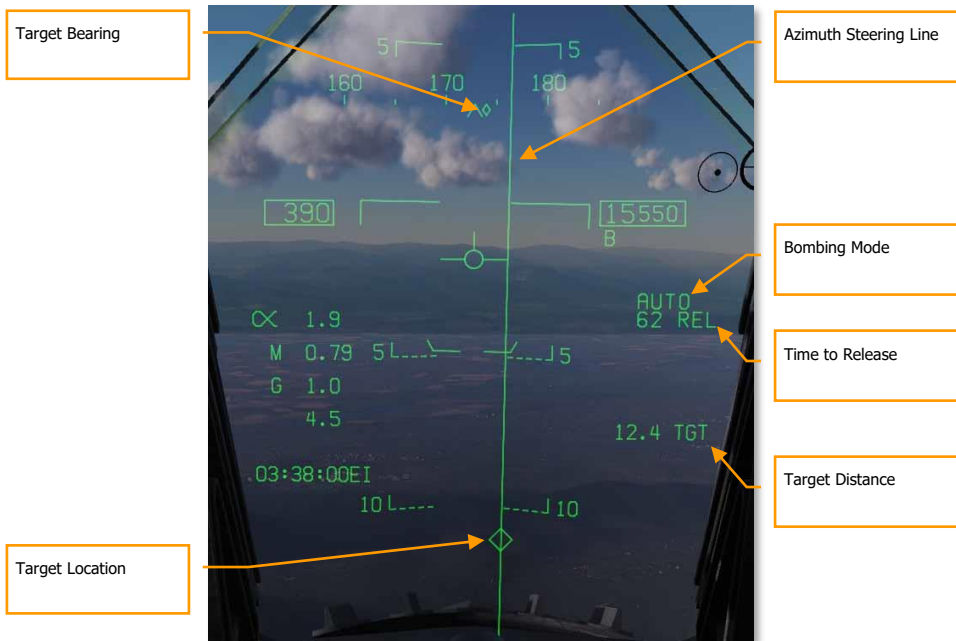

Figure 174. LGB AUTO HUD

## Paveway III Series

The Paveway III-series of laser-guided bombs introduces further enhancements over the Paveway I and Paveway II weapons. Most notably, Paveway III guidance kits eschew traditional "bang-bang" guidance (where the control fins are only fully deflected in one direction or the other) for proportional deflection, where the control fins can move in increments to steer the bomb, giving the bomb longer range. The Paveway III electronics also gives the bomb more guidance capability, which is reflected in updated avionics controls. The GBU-24 is the Paveway III variant with a 2,000-pound warhead (equivalent to a Mk. 84).

The Paveway III computes a launch acceptability region (computed LAR or CLAR). If the bomb is dropped within this region, it can maneuver onto a target that is being lased. To compute the LAR, the Paveway III must know the approximate location of the target being lased (for example, co-located with a designated waypoint). The Paveway III can calculate a "straight-line" LAR, a LAR that assumes the aircraft flies a straight line from its present location directly to the target; or it can calculate a "pre-planned" LAR, which assumes the pilot attacks the target from a pre-determined heading.





Figure 175. GBU-24 STORES Format

The STORES format for the GBU-24 is like previous-generation laser-guided bombs, with additional options to control Paveway III-specific features.

**Delivery Mode.** Allows the pilot to choose between CLAR PP (pre-planned computed LAR), CLAR SL (straight-line computed LAR), and MAN (manual) delivery modes.

**Program.** Displays the release program, including the release mode and the pre-planned heading used by the CLAR PP delivery mode.

**Laser Code.** Pressing PB1 allows the pilot to use the UFC to set the laser code that the bomb will search for.

**Time to Release.** When outside the LAR, this line displays the time until reaching the LAR. (TTR is omitted when 10 minutes or greater.) Once inside the LAR, it displays IN ZONE. Displays TOO LOW if the aircraft is below the minimum release altitude.

**Time on Target.** An estimation of the Zulu time of weapon impact. Only displayed when inside the LAR. After the bomb is released within the LAR, this line is replaced by a time-to-impact countdown.

**CLAR Override.** Normally, the bomb can only be released when the aircraft is inside the LAR. When this option is boxed, the Weapon Release button is always hot, and post-release lasing is disabled. The CLAR Override option is saved on a per-program basis.

**UFC Control.** Places program settings on the UFC for the pilot to edit. The UFC will display the program settings common to all bombs (quantity, multiples, interval), as well as a CLAR option that allows the pilot to enter the pre-planned attack heading.

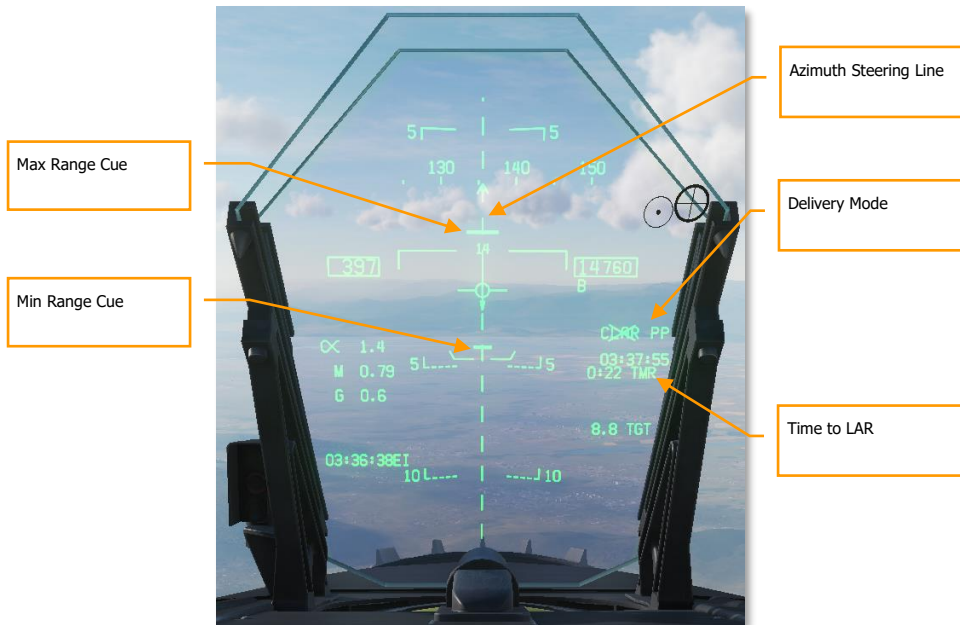

Figure 176. Paveway III HUD, Outside LAR

**Azimuth Steering Line.** Displayed as dashed when outside LAR. Becomes solid when inside LAR, or when CLAR OVR is selected (making the Weapon Release button hot).

**Time to LAR.** Identical to the STORES page indication; displays the time until penetrating the LAR, or IN ZONE when in the LAR, or TOO LOW when below the minimum release altitude.

**Min/Max Range Cue.** Represents the minimum and maximum extent of the LAR along the attack axis. These cues flash when the aircraft is within 1,000 feet of the minimum release altitude.



Figure 177. Paveway III HUD, In LAR

**Relative Range Cue.** Displays the aircraft’s current position between the min and max range cues, when inside the LAR.

**Cross-Range Cue.** Represents the lateral extent of the LAR at the aircraft’s position. Clamped to the edges of the heading tape at wider extents.



Figure 178. HSI Format, Paveway III Attack

**LAR.** The launch acceptability region. Pre-planned LARs are displayed as orange and straight-line LARs as green. The straight-line LAR is only displayed when target steering error is less than 20°.

### Using the GBU-24

To make a pre-planned attack using the GBU-24, first ensure that the target location is designated. You can designate a target using the HSI, the FLIR, or the A/G radar. Verify that the aircraft is in A/G master mode and MASTER ARM is on. Verify that the LTD/R is powered on if you will be lasing your own bomb.

1. On the STORES format, box GB24.
2. For a pre-planned attack, set the MODE to CLAR PP by pressing the MODE pushbutton. For a straight-line attack, set the MODE to CLAR SL.
3. For a pre-planned attack, press the UFC pushbutton, then press the Option Select Button labeled CLAR, then the Option Select Button labeled HDG. Enter the attack heading (true heading) and press ENT on the UFC.
4. On the STORES format, verify the laser code and fuzing are correct.
5. Fly the aircraft into the LAR. The ASL will become solid, and the Weapon Release button will be hot. Press the Weapon Release button to release the weapon. If the LTD/R is powered on, it will automatically begin lasing prior to predicted impact time.

The GBU-24 can also be used for on-call attacks when another platform is lasing. On the STORES page, pressing the CLAR OVR pushbutton will inhibit normal release calculations and allow the bomb to be released immediately.

A strong crosswind can have an unanticipated effect on the LAR. In a crosswind, the aircraft must crab into the wind to maintain a straight ground track to the target. This points the bomb's seeker head upwind. This forces the LAR to shift upwind, even though after release the bomb will drift downwind. In sufficiently strong crosswinds, flying the ASL may never result in the aircraft penetrating the LAR.

## INS/GPS-GUIDED WEAPONS

The INS/GPS-guided weapons within the DCS: F/A-18C include both the Joint Direct Attack Munition (JDAM) and the Joint Stand-Off Weapon (JSOW). Both allow considerable standoff range when combined with high-altitude, high-speed launches. They offer excellent accuracy with launch-and-leave capability.

**Joint Direct Attack Munition (JDAM)** is a low-drag general-purpose bomb fixed with an attached JDAM guidance kit. Guidance is obtained by an onboard Inertial Navigation System (INS) aided by a Global Positioning System (GPS) processor. The JDAM guidance kit provides accurate guidance in all-weather conditions, day or night. JDAM is a programmable system that allows multiple weapons to be independently targeted prior to release. Targeting data are entered as lat/long/alt coordinates and are provided to the weapon by the pilot via the avionic interfaces. For the most accurate programming, precise hour:minute:second to hundredth of a second is available through the Mission Editor and F10 map by pressing **[LAlt] + [Y]**.

DESIGNATION	BOMB	PGM KIT	RACK	STATIONS	FUZE OPTIONS
<b>GBU-31(V)1/B</b>	Mk. 84 (2,000-lb warhead)	KMU-556/B	BRU-32	2, 3, 7, 8	Nose: DSU-33A/B, DSU-33B/B Tail: FMU-152/B, FMU-139A/B
<b>GBU-31(V)2/B</b>	Mk. 84 (2,000-lb warhead)	KMU-556/B	BRU-32	2, 3, 7, 8	Nose: DSU-33A/B, DSU-33B/B Tail: FMU-152/B, FMU-139A/B
<b>GBU-31(V)3/B</b>	BLU-109 (2,000-lb penetrator warhead)			2, 3, 7, 8	Tail: FMU-152/B, FMU-139A/B
<b>GBU-31(V)4/B</b>	BLU-109 (2,000-lb penetrator warhead)	KMU-558/B	BRU-32	2, 3, 7, 8	Tail: FMU-152/B, FMU-139A/B
<b>GBU-32(V)2/B</b>	Mk. 83 (1,000-lb warhead)	KMU-559/B	BRU-32	2, 3, 7, 8	Nose: DSU-33A/B, DSU-33B/B Tail: FMU-152/B, FMU-139A/B
<b>GBU-38/B</b>	Mk. 82 (500-lb warhead)	KMU-559/B	BRU-32 (×1), BRU-55 (×2)	2, 3, 7, 8	Nose: DSU-33A/B, DSU-33B/B Tail: FMU-152/B, FMU-139A/B

EFUZ options: INST (instantaneous), DLY1 (delayed).

**AGM-154 Joint Standoff Weapon (JSOW)** is a glide weapon that allows much greater attack distances than the JDAM, but still uses INS/GPS navigation for great accuracy. As with JDAM, it can be targeted against replanned (PP) targets or targets of opportunity (TOO) and is a 1,000 pound-class weapon with a launch range up to 15 nm at low altitude and 60 nm at high altitude.

DESIGNATION	BOMB	RACK	STATIONS	FUZE OPTIONS
<b>AGM-154A</b>	BLU-97/B (combined effects bomb)	BRU-32 (×1), BRU-55A/A (×2)	2, 3, 7, 8	Tail: FMU-152/B, FMU-139A/B
<b>AGM-154C</b>	BROACH (multi-stage penetrating)	BRU-32 (×1), BRU-55A/A (×2)	2, 3, 7, 8	Tail: FMU-152/B, FMU-139A/B

### *INS-GPS Weapon in TOO Mode*

1. Master Arm switch to ARM
2. Master Mode switch to A/G
3. Select JDAM or JSOW bomb from top of the SMS page
4. Select TOO mode
5. Allow weapons to align down to 7:30 for GOOD ALN QUAL
6. Set EFUZ to INST
7. Select JDAM/JSOW DSPLY
8. Set QTY (quantity to drop)
9. Designate desired target
10. Align steering with target bearing and press weapon release button when IN RNG cue on HUD is displayed

### *INS-GPS Weapon in PP Mode*

1. Master Arm switch to ARM
2. Master Mode switch to A/G
3. Select JDAM or JSOW bomb from top of the SMS page
4. Select PP mode
5. Allow weapons to align down to 7:30 for GOOD ALN QUAL
6. Set EFUZ to INST
7. Select JDAM/JSOW DSPLY
8. Set QTY (quantity to drop)
9. Select MSN (pre-planned mission)
10. Select PP mission (1 to 6)
11. Select the TGT UFC and enter ELEV (elevation) and POSN (position coordinate) of the mission target
12. Align steering with target bearing and press weapon release button when IN RNG cue on HUD is displayed

## Weapon Selection

Upon initial weapon selection and timing is complete (after 2:30), all currently inventoried weapons of the same variant are placed into STBY (standby) status as indicated under their respective weapon acronyms. All weapons simultaneously begin alignment and will remain initialized if at least one weapon station of the same type is selected.

Deselecting JDAM/JSOW will likewise cause all weapons of the same type to spin down, requiring at least 2.5 minutes for warmup to complete again. Consideration should therefore be given to this warmup cycle when mission planning. The status of this alignment cycle is indicated on the STORES format and JDAM/JSOW displays as a TIMING cue which is initialized to 10:00 minutes and counts down. The TIMING cue is removed when the Time-to-Go (TTG) reaches 7:30 (alignment is GOOD after 2:30).

When a GPS weapon is initially selected, all stations of the same store type are simultaneously placed in STBY until the TIMING cue is removed, at which point the priority station will either remain in STBY or transition to RDY (ready), depending on A/G Ready status (i.e., warmup complete, designation exists and is valid). All

additional stores of the same type will remain in STBY until selected (RDY cue), explicitly deselected, or indirectly deselected by the selection of a different weapon type or upon transition to A/A master mode.



Figure 179. GPS Weapon SMS Format

### JDAM JSOW Stores Format

As with other A/G stores, all GPS weapons including JSOW and JDAM may be selected in NAV or A/G master modes by boxing the applicable weapon acronym from weapon selection menu across the top row of push buttons from the STORES platform format.

JDAM and JSOW versions are listed as follows on the JDAM format page:

- J-109 = GBU-31(V)4/B
- J-84 = GBU-31(V)2/B
- J-83 = GBU-32(V)2/B
- J-82 = GBU-38 (needs BRU-55A/A)
- JSA = AGM-154A
- JSC = AGM-154C

Selection of any GPS weapon on the STORES format applies power to every inventoried GPS weapon of the same type. Power remains applied to the GPS weapons until deselected. A GPS variant is deselected only when the associated weapon select option is unboxed explicitly, or another weapon type is selected. When operational power is first applied, warm-up and transfer alignment begin. As soon as warmup is complete (2.5 minutes from initial power up), the weapon may be armed for release. Note that the alignment quality is not a prerequisite for release interlocks and achieving an alignment quality of GOOD may take as long as 10 minutes.





Figure 180. GPS Weapon SMS Format

**Weapon Station/Status.** The priority station is boxed when selected and is the station which is currently accepting targeting data. The station status cue represents the status or health of the station.

- **Priority Station.** Selecting a PP# mission option (or TOO) assigns that mission (or TOO) to that specific station. Subsequently changing the priority station will load any previously selected mission for that station. For example, station 3 may be assigned to mission PP2 and station 9 may be assigned to mission PP1.
- **Station Status Cue.** Displayed below each station on the wing planform is the station status. When any single GPS weapon is selected, all stations with the same variant are automatically places into standby. Only the priority station is boxed, but a STBY status is displayed at each useable station unless overridden by a higher priority status (e.g., SFAIL or WFAIL). If the status of any weapon in the quantity changes, the status reflects the change, but the weapon remains in the quantity.

**ALN QUAL.** Indicates the priority station navigational state. This is the state of the weapon's internal guidance alignment status. Weapon INS alignment quality takes time to improve. This cue consists of a numeric value from 01 (best) to 10 (worst) and a plain language cue of UNST, MARG or GOOD. All weapons initialize in the 10 UNST state.

- Time 10:00 to 9:15: ALN QUAL 10 to 7, UNST
- Time 9:15 to 8:30: ALN QUAL 6 to 3, MARG
- Time 8:30 to 7:40: ALN QUAL 2 to 0, GOOD

**ARM/SAFE Cue.** The status of the master arm logic is continuously displayed in 200% size letters as:

- **SAFE.** The weapon is disarmed

- ARM. The weapon is armed, but not necessarily RDY
- SIM. The weapon is disarmed, in Simulation (SIM) mode. When simulation mode is selected, SIM is displayed in this location in place of SAFE or ARM

**STEP Option.** Provided when the SMS determines that more than one weapon of the selected type is available for release and the quantity is greater than 1. Each successive depression of the STEP option causes the SMS to change the priority station indication to the next available station in the station priority sequence. If a release quantity of more than one is selected for a given conventional, laser-guided, or GPS-guided bomb, the SMS will automatically step to the next available priority station before releasing the next weapon in the salvo. The first weapon released in a quantity release is always from the station which is currently selected. The priority station the SMS chooses in quantity releases is prioritized based on loading priority to reduce to a minimum the lateral moments created by asymmetrical loads. For example, if a weapon is released from an outer wing pylon, the SMS will select the matching opposite pylon (if available) for the next station in the priority sequence.

**Range Status.** The Range Status cues refer to the weapon at the priority station:

- ## TMR. If the aircraft is outside the Launch Acceptability Region (LAR) and the target is within the forward hemisphere of the aircraft, this cue will read ## TMR indicating the time in seconds (99 max) until the aircraft is within the maximum range of the weapon at the current (no launch zone specified), or reference (LZ specified) altitude.
- IN RNG. If the aircraft is within the aerodynamic range of the weapon, but is not yet within the LAR, IN RNG will be displayed here. Generally speaking, and at least in terms of the current simulation, IN RNG will be transient, as IN ZONE will occur almost immediately following IN RNG.
- IN ZONE. This cue indicates the aircraft is within the LAR and the weapon should be released.

**A/G Ready.** When a weapon of any type other than the gun is selected, the corresponding A/G menu acronym will be boxed just as it is under the individual stations. The status for the weapon is also echoed here. Pressing a boxed weapon option will deselect that weapon and select no weapon. Likewise, selecting an unboxed weapon will select that weapon, and the SMS will automatically provide the selected station based on the priority sequencing algorithm.

**Fuzing Status.** The EFUZ or MFUZ fuze status due indicates the armed or safe status of the fuzes for the selected JDAM.



Figure 181. GPS Weapon SMS Format

**Weapon Mode.** [PB5] selects the GPS targeting mode for the priority station.

- Pre-Planned (PP). Instructs the priority weapon to execute the selected pre-planned mission, if valid.
- Target of Opportunity (TOO). Instructs the priority weapon to cue to the sensor-designated target, if any.

**ERASE JDAM/JSOW.** This option immediately clears all GPS weapons of the selected variant of all previously entered pre-planned (PP) mission data. JDAM/JSOW ERASE is boxed when selected and remains boxed for 5 seconds. JDAM/JSOW ERASE cannot be undone. If JSOW is the selected weapon, ERASE JSOW is displayed.

**Electrical Fuzing.** Located at pushbutton 3 when an electrical fuze is mounted to the selected JDAM or JSOW. Upon selection, pushbutton 5 displays OFF, pushbutton 3 displays INST, and pushbutton 2 displays VT1 or DLY1 for FMU-139 fuze.

- If DSU-33 is present = VT1
- If DSU-33 not present = DLY1

**Priority Station.** The currently selected priority station. If A/G Ready is false (e.g., weapon is warming up, Master Arm false, or no valid target exists, or the label is X'd out). This is shown as STA (station number). For example, STA7. To the right is the status of the selected station and can be:

- RDY, ready
- RDY-D, ready but degraded
- FAIL, failed

- TEST, in BIT
- XFER, transferring target data in MUMI page
- STBY, standby

**JDAM/JSOW DSPLY Format Select.** This option, at pushbutton invokes the JDAM/JSOW Format for mission data entry.

Upon selecting the JDAM/JSOW Display Format at pushbutton 11, the following page functions and information is available:



Figure 182. GPS Weapon SMS Format

**HSI Declutter.** When boxed, this option removes any weapon specific HSI symbology which lies outside of IRLAR circle (see HSI Symbology, below). Later in early access.

**Quantity Release (QTY).** Pressing this option at pushbutton 15 displays stations loaded with the JDAM or JSOW type as selected from pushbutton 11 to 14. Only stations loaded with JDAM or JSOW are displayed.

- Pushbutton 11 = STA2
- Pushbutton 12 = STA3
- Pushbutton 13 = STA7
- Pushbutton 14 = STA8

Selecting a station boxes it and adds it to the QTY value. RTN exits the quantity release selection. 4 is the maximum allowable quantity. Each selected station will be cued to release on the selected target in PP or TOO mode.

**Release Type.** This cue lists the selected release mode for the selected weapon: MAN (Manual), AUTO LOFT, and FD (Flight Director). Manual is mode is implemented at this time in the early access. Upon selection of the release mode, the selection displayed to the left of the release quantity.

**Mission Select (MSN).** Located at pushbutton 4, selecting the mission displays the mission format page for either PP or TOO modes.



**Mission Options.** This page allows the player to create Target Data Sets (TDS) for the selected JDAM against the selected target. The Mission Data (MSN) format is accessed by pressing the MSN option at pushbutton 4. The Mission Data format is used to select and program one of the 6 available PP missions. A mission is selected by depressing one of the PP# options at [PB6]-[PB11]. One of the various UFC options along the lower right side of the format is then selected to begin program data entry. Note that program data may be pre-programmed in the Mission Editor. If TOO mode is selected, mission data for the selected Target (TGT) is displayed.

### *Pre-Planned (PP) Missions SMS Format*

Pre-Planned allows entry of specific target coordinates. This option is what is referred to as a *Pre-planned* (PP) Mission. In the current early access, this is done through coordinate entry via the UFC. There is a total of six PP missions available for programming and each weapon station may be assigned to any one of these missions. The MC then determines the maximum range of the weapon at the current altitude and airspeed. A PP mission is selected by boxing one of the 6 available PP mission pushbuttons located along the top of the MSN display.



Figure 183. GPS Weapon SMS Format

**Mission Select Number Options.** Pre-Planned (PP) mission targets are set either in the Mission Editor or via the UFC and up to six can be selected from pushbutton 6 to 11. The selected PP mission is boxed. If a PP mission does not contain valid coordinates and elevation, the PP(x) legend is X'd out. PP missions are not displayed when in TOO mode.

**Target Data.** The target coordinates and elevation for the selected PP mission may be specified via the UFC, and if valid, are displayed here. They may also be set as a preplanned target created in the Mission Editor. If the target is an OAP (an offset was specified), the *TGT* label becomes *OAP*, and the *OAP* relative bearing and distance are displayed to the right of the *OAP* data area. The latitude and longitude of the target are displayed in this data block, as well as target elevation.

**Target Data Entry.** Upon selecting the Target Data UFC Entry pushbutton 14, you will use the UFC to enter the target coordinate and elevation for the selected PP mission.



**POSN** is the lat / long coordinate of the target. This is entered as longitude and longitude in degrees, minutes, and seconds.

**ELEV** can be entered in FEET or MTRS (meters). Valid range for FEET is -328 to 32808 and MTRS is -100 to 10000. We will skip MSL or WGS selection as pictured below.

Once a valid elevation and target coordinate have been entered and saved, the selected PP mission will no longer have an "X" through it and the TGT (target) information on the MSN screen will be complete.

**Terminal Phase Options** are entered as the weapon impact angle, weapon impact heading, and weapon impact velocity. Selecting TERM displays three options on the UFC for:



- HDG. Heading of weapon at time of impact. Valid range if from 0° to 359°.
- ANG. This is the impact angle of the weapon. Valid range is 0° to 90°.
- VEL. Velocity at impact. Valid range is 100 to 26800 feet per second.

### *Target of Opportunity (TOO) Missions*

TOO initializes the selected weapon with the current ground target. Currently, this is set as the designated waypoint (WPDSG). Any subsequent weapons in the same salvo (using QTY) which are also using TOO will receive the same coordinates. The primary difference from PP mode is the ability to set a target point (TGT) using a waypoint or sensor.

Upon selecting MSN at pushbutton 4, the TOO mission page will display the elevation and coordinates of the target. At this stage in the early access, this will be a designated waypoint. As with PP mode, the target elevation and coordinate are displayed on the SMS TOO mission format.

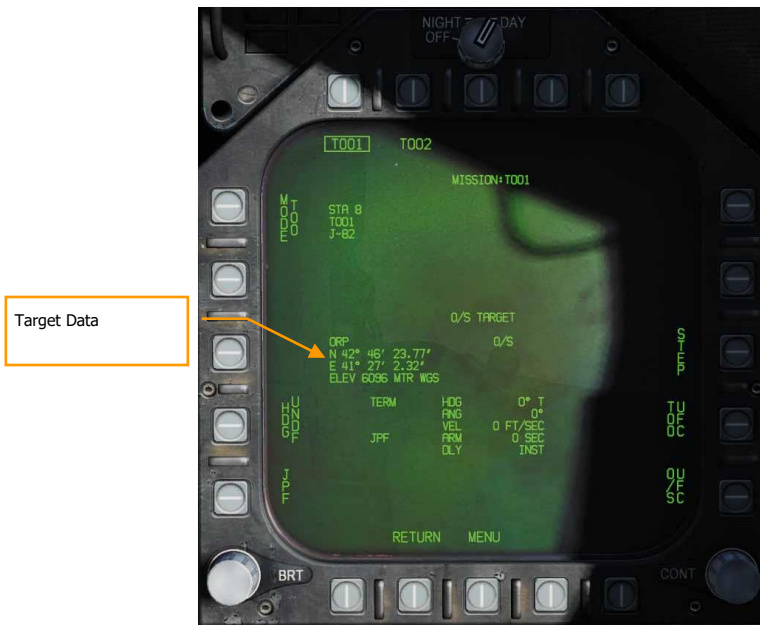

Figure 184. GPS Weapon TOO SMS Format

### JDAM and JSOW HSI Format

When a TOO target or PP mission has been created with a valid elevation and coordinate, the target/mission location is displayed on the HSI, along with the minimum range, in range launch acceptable region (LAR), and predictive maximum range bar. There are provided to better visualize target/mission location regarding weapon range.

**JDAM/JSOW Target.** This is a solid triangle symbol at the location of the PP target location, or a solid diamond if a TOO target location. The symbol shows the last selected PP or TOO mission.

**Minimum Range.** This is a circle that is centered on the target and indicates the minimum acceptable launch radius of the selected JDAM or JSOW. This cue is not displayed when the aircraft is within the IZLAR.

**In Range LAR (IRLAR).** This larger circle is also centered on the target and represents the range at which the selected JDAM or JSOW can be launched under current flight conditions (heading, altitude, and airspeed) and provide a minimum impact angle of 35° and a minimum impact velocity of 300 feet per second. This cue is removed when the aircraft is within the IRLAR.





Figure 185. GPS Weapon HSI Format

**Predictive Max Range.** This dashed line indicates the absolute maximum launch range to the target, not accounting for impact angle and speed. This will always be greater than the IRLAR. The line will run from the target and through the ownship. At the end of the dashed line is a bar. This bar should always be at 60 nm which is the best-case maximum range for a JSOW.

### *JDAM and JSOW Manual Mode HUD*

With a TOO target or PP mission created, steering commands, distance, and release zone indications are provided on the HUD when in manual mode. For manual mode, there is no azimuth steering line or release cue as normal for AUTO modes. Instead, target/mission bearing is indicated and an in range (IN RNG) cue is provide when the weapon is between minimum and maximum range.

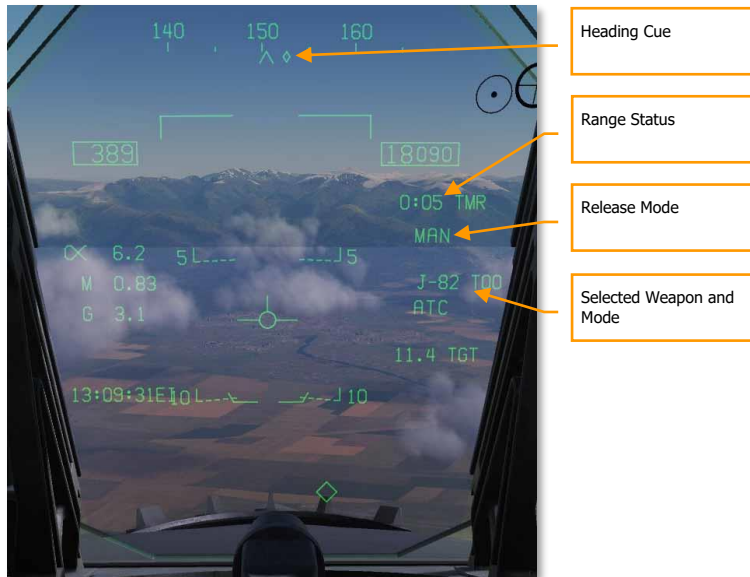

Figure 186. GPS Weapon MAN HUD

**Heading Cue.** This cue on the heading tape provides steering direction to the IZLAR. If a release quantity of more than 1 is selected, this cue is not displayed and the waypoint or TACAN cue is displayed instead.

**Range Status.** The Time to Maximum Range (TMR) is visible when the aircraft is within 10 minutes of reaching the IZLAR. It will then start at 9:59 and count down as range closes. Once the aircraft is within the IRLAR, the cue changes from TMR to IN RNG. The IN RNG will flash if the aircraft is within 5 seconds of flying outside the INLAR or inside the minimum range zone. If the aircraft is inside the IZLAR zone, then the cue changes to IN ZONE.

**Release Mode.** Shown as MANUAL when in manual mode. If not in MAN, AUTO LFT is displayed.

**Selected Weapon and Mode.** Displays the name of the selected weapon type (J-83, J-84, J-109, or 154A) and either TOO or PP based on mode selection.

# AIR-TO-GROUND GUN AND ROCKETS

Two modes for the A/G gun and rockets are available from the A/G Stores page: CCIP and MAN. These can be enabled by selecting the weapon from the A/G SMS page and then selecting the desired delivery mode. They feature either a "point and shoot" CCIP reticle or a manually adjusted manual sight based on a manual mil setting. Both the A/G Gun and Rockets are very similar in their programming, HUD, and delivery modes.

## Weapons Practice: F/A-18C A/G Gun and F/A-18C Rockets

### *How to Use A/G Guns*

1. Master Mode switch to A/G
2. Select/box GUN on the A/G SMS page with no other weapon selected
3. Select Mode as CCIP
4. Fly to place the pipper in the center of the Reticle over the target and hold down the trigger when the IN RNG cue appears on the HUD

### *How to Use Rockets*

1. Master Mode switch to A/G
2. Select rockets at the top of the A/G SMS page
3. Select Mode as CCIP Mode
4. Fly to place the pipper in the center of the Reticle over the target and hold down the trigger when the IN RNG cue appears on the HUD

## A/G Gun SMS Page



Figure 187. A/G Guns SMS Page

1. **A/G Gun Option.** The A/G gun is selected by pressing the GUN Option Select Button on the A/G SMS page. If another weapon is selected, the gun will operate in Hot Gun mode (fixed 2,000 ft gun cross). When selected, the GUN legend is boxed and an RDY (Ready) indication is displayed to the left of the box.
2. **Mode Selection.** Separate buttons are available for CCIP and MAN modes. Selecting a mode boxes the legend.
3. **Gun Ammunition Type.** Gun ammunition can be selected between M50 and PGU-28B 20mm rounds. The selected gun round type is boxed.
4. **Gun Fire Rate.** HI (High) and LO (Low) gun fire rates can be selected with the selection being boxed.
5. **UFC.** When the Mode is set to MAN (Manual), the UFC Option Select Button is displayed. Pressing this button boxes the legend and allows the pilot to manually enter the gun reticle depression on the UFC. The value can range from 0 to 270 mils. Once complete, the ENTER button on the UFC is pressed to save the value. Note that this value is not saved to a program.
6. **Reticle Setting.** Next to the RTCL is the entered reticle setting in mils.
7. **Gun Rounds Remaining.** At the top of the wingform, the number of gun round remaining is displayed, with a full load being 578 rounds.

## Rockets SMS Page



Figure 188. Rockets SMS Page

1. **Rocket Selection.** The top row of options is used to select the desired A/G weapon. One option is provided for each displayed weapon type (maximum 5). An abbreviation of the selected weapon type is displayed below the push tile. When a weapon is selected, the abbreviation is boxed. Pressing the button again will unselect the weapon. If the A/G weapon is in a release condition, "RDY" is displayed below the weapon box. Otherwise, an "X" is displayed through the weapon box.
2. **Wingform Indication.** When a rocket pod is selected, its indication on the Wingform will be boxed. Next to the rocket type abbreviation, the number of remaining rockets in the pod on the station is indicated. Successive presses of the STEP button will cycle the selected weapon station of rockets of the same type.
3. **Mode Selection.** Separate buttons are available for CCIP and MAN modes. Selecting a mode boxes the legend.
4. **Firing Mode.** Options for SGL (single) and SAL (salvo) are displayed when more than one rocket pod of the same type is loaded on the aircraft. When SGL is selected, one rocket will be launched with each press of the Weapon Release Button. When SAL is selected, two rockets will be launched with each press of the Weapon Release Button, from different rocket pods.

When SAL is selected, the weapon STEP option is not available.

5. **MTR (Motor) Type.** Most rockets can have one of two motor types: M4 or M66. Presses of the MTR Option Select Button cycles between the two types with the selected being boxed.
6. **UFC.** When the Mode is set to MAN (Manual), the UFC Option Select Button is displayed. Pressing this button boxes the legend and allows the pilot to manually enter the rocket reticle depression on the UFC. The value can range from 0 to 270 mils. Once complete, the ENTER button on the UFC is pressed to save the value.
7. **Reticle Setting.** Next to the RTCL is the entered reticle setting in mils.

## A/G Gun and Rocket HUD

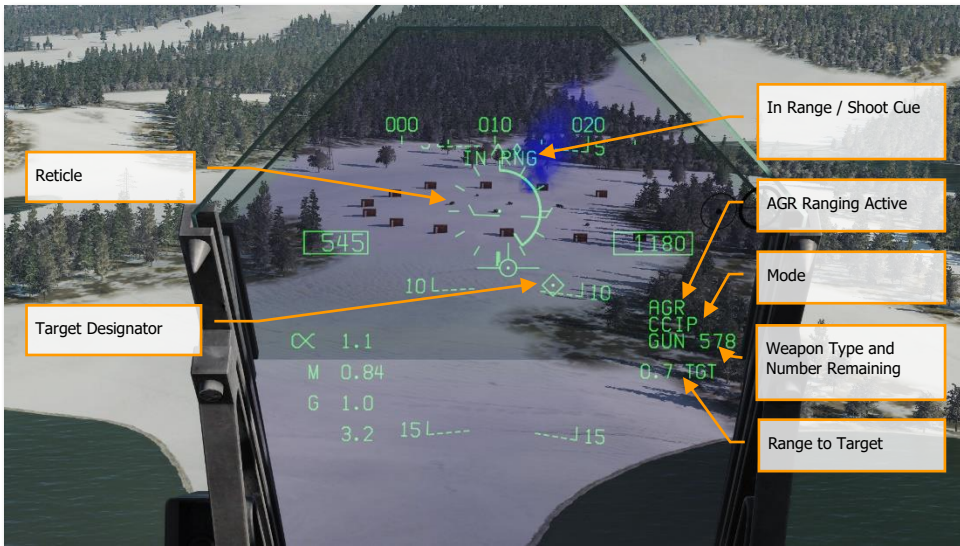

Figure 189. A/G Gun HUD

**Reticle.** This Reticle consists of tic marks in 50-mil diameter circle with a pipper in the center. When in CCIP mode, the Reticle indicates the calculated impact point of the gun rounds/rocket. When in MAN mode, the reticle is adjusted based on the depressible mils setting from the SMS page/UFC.

When in CCIP mode, an analog range bar is inscribed within the reticle. Slant range is provided by the radar via Air to Ground Ranging (AGR) and barometric altitude. Each tic mark on the reticle represents 1,000 feet of slant range and can indicate ranges from 0 to 23,000 feet. The bar will rotate clockwise to indicate increasing range and rotate counterclockwise to indicate decreasing range.

**In Range / Shoot Cue.** When in CCIP mode and the gun/rocket is within maximum slant range of the pipper's aim point, the "IN RNG" cue is provided. If, however, there is a designated ground target, the "SHOOT" cue will be displayed if the gun/rocket is within range of the target.

**Mode.** The selected delivery mode for the gun/rocket is indicated as either CCIP or MAN based on the SMS page program setting.

**AGR Ranging Active.** When in CCIP mode and the radar is using AGR to determine range, the RDR indication is displayed. (Coming later in Open Beta)

**Weapon Type and Number Remaining.** The selected weapon name and the number of remaining rounds/rockets are displayed and updated as weapons are expended. This will display either GUN or RKT (rockets).

**Range to Target.** When a target has been designated and in CCIP mode is enabled, the range to the target is displayed in miles.

**Target Designator.** When the TDC is assigned to the HUD, the TD is displayed as a diamond within the HUD field of view with a pipper in the center. The TDC can then slew the TD within the HUD field of view.

When in MAN mode, true airspeed is displayed below the calibrated airspeed box.

Pressing the Cage/Uncage Button will fix the CCIP Reticle to 5,000 feet slant range.

NOTE: In the Mission Editor, there is an Aircraft Properties tab in the Aircraft/Payload menu. This can be used to set rocket pods on the inboard and outboard stations to ripple or single release.

# AGM-65 MAVERICK

## Mission Practice: AGM-65E Laser Maverick

The F/A-18C can carry two versions of the AGM-65 Maverick air-to-ground missile: a laser guided version (AGM-65E) and the infrared guided AGM-65F. These missiles are carried on the LAU-117A(V)2/A single rail launcher, which is attached directly to the BRU-32/A racks on wing stations 2, 3, 7, and 8. The F/A-18C does not support multiple carriage of AGM-65s on a single station.

- **AGM-65E Laser Maverick:** This is a 641-pound missile containing a laser-guidance system and solid fuel rocket motor. The guidance system automatically locks-on and tracks targets being illuminated by a properly coded laser illuminator (from a targeting pod or JTAC). For this example, we will use JTAC laser designation.
- **AGM-65F IR Maverick:** This is a 675-pound missile containing an infrared detector system and solid fuel rocket motor. The missiles provide infrared raster video to allow lock-on and tracking of targets which provide sufficient temperature contrast.

These Mavericks are automatically displayed on the Stores Management System page when a Maverick weapon is selected, and the SMS is set to a Maverick weapon station. The Maverick formats can also be selected through the TAC MENU, which contains an option (MAV for the AGM-65E or MAVF for the AGM-65F) when a Maverick weapon station is selected.

### *How to Employ the AGM-65E*

1. Master Arm to ARM and Master Mode switch to A/G
2. Select MAV from the Stores TAC page
3. Contact the JTAC radio and input directed laser code
4. Fly to place target within 40 degrees off nose and press Cage/Uncage button **[C]** to scan for laser designation
5. Press and hold the Weapon Release button **[RAIt] + [Space]** to launch the missile when laser designation is locked and within 8 nautical miles

## AGM-65E Laser-Maverick on SMS Page

When an AGM-65E is loaded on the aircraft, its MAV code is displayed beneath the station is loaded on. The selected station for launch has the MAV indication boxed. Selection of the Maverick station can be cycled with the STEP option on pushbutton 13. Beneath each station is the four-digit laser-code. This code can be changed by pressing PB 14, labeled "UFC."

MAV is listed below one of the top pushbuttons (6 to 10) and is boxed when selected. It will be crossed-out when the Maverick has not reached launch criteria.



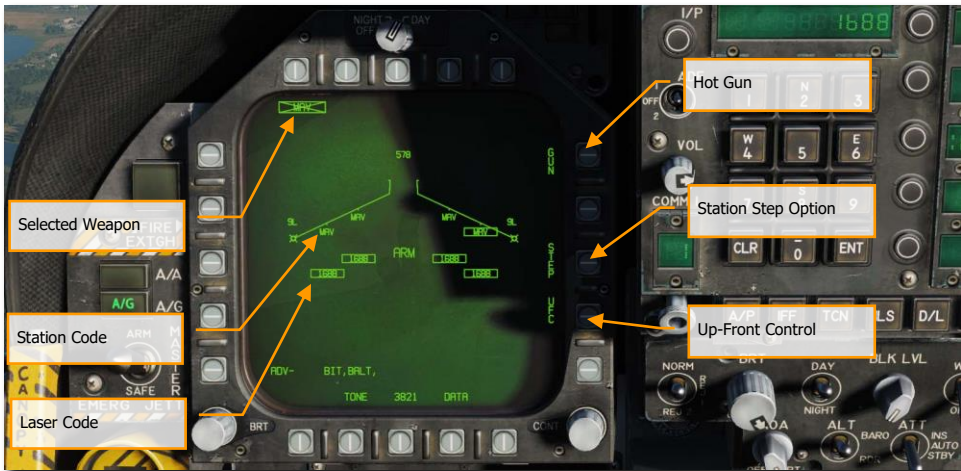

Figure 190. AGM-65E Stores Page

**Up-Front Control.** This option is selected to enable the Up-Front Control for entry of the laser code. Separate laser codes may be entered for each Laser Maverick on board, and do not have to be the same as the laser code for the Laser Spot Tracker or FLIR LTD/R.

**Station Step Option** -This option is provided when the SMS determines that weapons of the selected type are available for release from more than one weapon station. Each successive selection of the STEP option causes the SMS to change the priority station indication to the next available station in the normal station priority sequence which contains the selected weapon. The station priority sequence for the Laser Maverick is 8, 2, 7, 3

**Laser Code.** The entered code of the selected AGM-65E station.

**Station Code.** Station loaded with AGM-65E laser Maverick with MAV code.

**Selected Weapon.** Below pushbuttons 6 through 10 are listed the weapons detected as loaded. AGM-65E appears as MAV. The selected weapon for employment will have its code boxed. If the weapon is not in launch constraints, the code will be X'd through. Pressing the MAV will display the AGM-65E weapon format page.

## AGM-65E Laser-Maverick Format Page, Unlocked

Upon selecting MAV from the SMS page, the AGM-65E Laser Maverick symbology is displayed on the DDI. The Laser Maverick format is shown below.

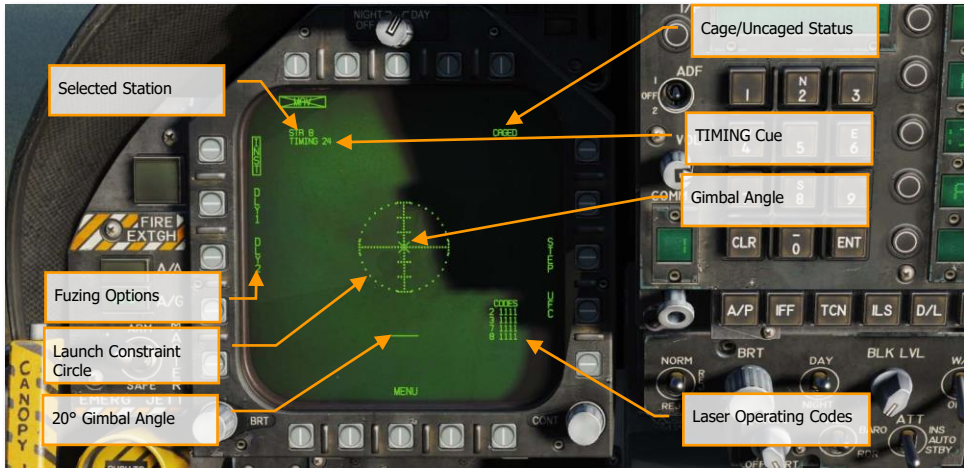

Figure 191. AGM-65E Format Page

**Selected Station.** The Laser Maverick can be carried on stations 2, 3, 7, and 8. The weapon station selected by the SMS is indicated beneath the weapon selection status. The priority sequence is 8, 2, 7, 3.

**TIMING Cue.** When the Laser Maverick weapon is selected, the SMS applies power (AGM-65 Select signal) to all LAU-117A(V)2/A launchers attached to Laser Mavericks and provides a timing signal to the MC for display on the Maverick format. To ensure that the Laser Maverick is ready for launch, the SMS sends a 30 second countdown timer to the MC, which is displayed as an advisory cue, **TIMING ##**. The time **##** decrements from 30 seconds to allow for worst-case gyro spin-up time and is removed at 0 seconds.

**Fuzing Options.** Three mutually exclusive fuzing options, instantaneous (INST) and two delay (DLL1, DLL2) options, are selectable for Laser Maverick electrical fuzing control. The selected fuzing is provided to the SMS for electrical fuse control via the AN/AWW-4(V) Fuse Function Control Set.

**Launch Constraint Circle.** The dotted launch constraint circle is part of the Maverick video. The radius of the circle is 15°. The horizontal tick marks represent 5° in elevation.

**Gimbal Angle.** The Maverick gimbal angle with respect to missile boresight is indicated by the "X" symbol which is part of the Maverick video. The "X" changes to a solid square symbol to indicate Maverick lock-on.

**20° Gimbal Angle** -The 20° gimbal angle position is indicated by the short horizontal line which is part of the Maverick video.

**Laser Operating Codes** -The current laser operating codes (entered via the UFC) are displayed for each Laser Maverick on board.

**Caged/Uncaged Status** -The caged/uncaged status of the weapon is continuously provided on the Maverick format. when the weapon is initially selected with no existing designation, CAGED is displayed. When an uncage signal is commanded to the missile (by depression of the uncage switch, action slewing of the TDC, moving the

Sensor Control switch to the Laser Maverick format to command track, or by making a designation), UNCAGED is provided on the format.

## AGM-65E Laser-Maverick Format Page, Locked

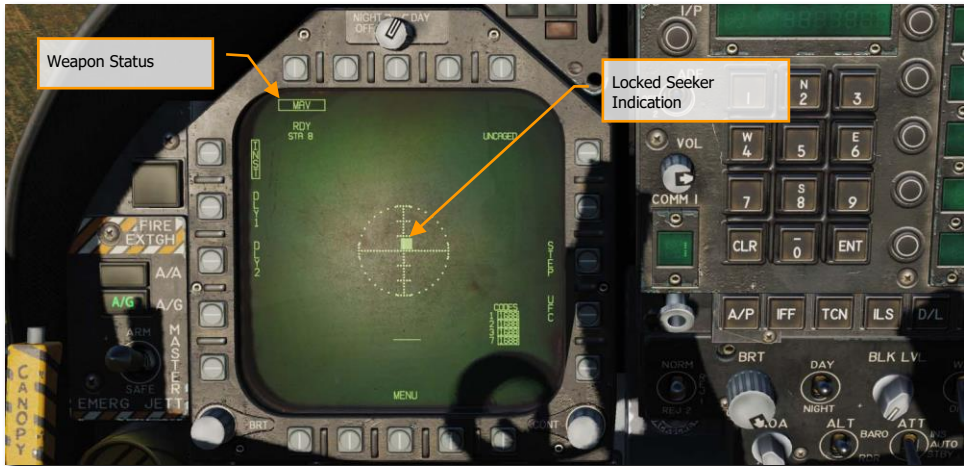

Figure 192. AGM-65E Format Page, Locked

**Weapon Status.** An indication of weapon selection status is provided which is identical to that provided on the Stores format. when an A/G release ready condition exists, RDY is displayed beneath the weapon selection box. Otherwise, an "X" is displayed through the IR Maverick acronym (IMAV). If the weapon selection option is selected as shown below, the IR Maverick is deselected, and the IR Maverick format automatically reverts to the Stores format.

**Locked Seeker Indication.** When the laser Maverick achieves a positive track on the laser designation, the Gimbal Angle "X" changes to a solid square and still indicates the weapon seeker angle.

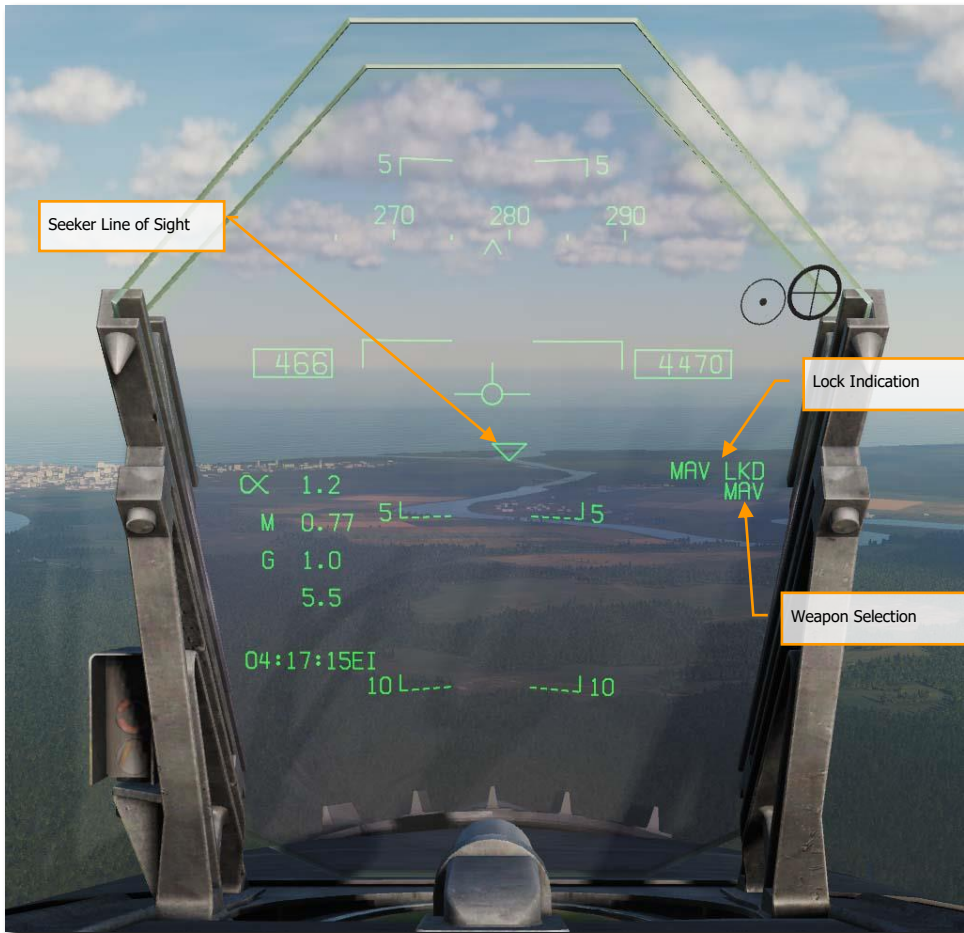

Figure 193. AGM-65E HUD

**Seeker Line of Sight.** This triangle symbol is centered in the HUD when the AGM-65E is selected as the active weapon. Upon seeker uncage, the symbol will perform a raster scan pattern across the field of view of the HUD in search of the laser designation matching the selected laser Maverick station. Upon detection and lock, the symbol is locked to the designated target and provides a line-of-sight reference.

**Locked Seeker Indication.** When the laser Maverick achieves a positive track on the laser designation, a MAV LKD (Maverick Locked) indication is displayed on the HUD.

**Weapon Selection.** When an AGM-65E is selected, MAV is displayed on the HUD.

## AGM-65E Format and Setting Laser Codes

From the laser Maverick format page, it is possible to enter laser codes for the Laser Mavericks, the Laser Spot Tracker, and the Laser Target Designator/Ranger using the UFC option. The laser codes are displayed on the wingform below the weapon wingform. When "UFC" is selected from the Stores format, all of the laser codes are boxed, and a single code may be entered for all laser stations using the UFC scratchpad, or the selected station may be cycled through the laser stations using the UFC option on the display (Sequence = all stations, 2, 3, 4, 6, 7, 8, all stations, 2, 3, etc.).

Depression of "ENTER" on the UFC enters a valid laser code if one was in the scratchpad and boxes the laser code(s) for the next laser station(s) in the sequence.

From the Laser Maverick format, it is possible to enter laser codes for all four Laser Mavericks using the UFC option. The laser codes can be displayed in a list on the right side of the format, with each Laser Maverick station and its associated code. When "UFC" is selected from the Laser Maverick format, all of the laser codes are boxed, and a single code can be entered for all laser stations using the UFC scratchpad, or the selected station can be cycled through the Laser Maverick stations using the UFC option on the display. Depression of "ENTER" on the UFC will enter a valid laser code if one was in the scratchpad and will box the laser code(s) for the next laser station(s) in the sequence.

## How to Launch an AGM-65E

At aircraft start-up the SMS applies power to all Laser Maverick weapon stations. When the Laser Maverick is selected in A/G master mode, the SMS automatically selects the first available weapon in the station priority sequence. (The priority station sequence is 8, 2, 7, 3). At the same time the SMS commands gyro spin-up of all available Laser Maverick missiles. After a 5-second delay, the SMS provides the code data to all Laser Mavericks aboard by simultaneously selecting each Laser Maverick station and applying the code signals to the weapon. When a designation does not exist, the selected weapon is initially caged, and the caged status is indicated at the upper right corner of the display. The priority station selected, and the Laser Maverick launcher timing indication are displayed in the upper left corner of the display. When time-out is complete (after 30 seconds), the "TIMING ##" indication disappears.

When the Laser Maverick is placed into the scan mode by assigning the TDC to the Laser Maverick and depressing and releasing the TDC or uncaging the missile [C]. The SMS then provides both the uncage and slew enable commands to the selected weapon. While the TDC is depressed, forces may be applied to the TDC to adjust the azimuth and/or elevation angle at which the Laser Maverick is scanning. When the Laser Maverick is uncaged and the cage/uncage switch on the throttle is depressed, the SMS applies the uncage command to the Maverick launcher which results in caging the selected weapon. The weapon must then have the slew or slave command applied to enable scan or slave mode, and subsequent lock-on.

The HUD format indicating a Laser Maverick selected in A/G mode is shown above. This format includes the triangle symbol which indicates the Maverick LOS. The symbol sweeps back and forth across the HUD when the Maverick is scanning and is limited at the HUD FOV limits and flashed when the Maverick LOS exceeds these limits. A/G ready is indicated on the HUD by the absence of the "X" through the MAV acronym.

The Laser Maverick automatically locks onto a target illuminated with a correctly coded laser from scan and slew modes. If the missile is caged at boresight, the gimbal angle "X" will flash indicating that the seeker senses correctly coded laser energy. The TDC must be depressed, uncage signal applied, sensor control switch moved, or a target designated to lock on (these commands slew, which allows lock-on). The gimbal angle symbol on the Laser Maverick format is replaced by a solid square, as shown above, to indicate lock-on. Also, MAV LKD will be displayed on the right side of the HUD. The aircraft is maneuvered to satisfy the launch constraint and in-range criteria and the weapon release button is depressed for launch of the Maverick.

## AGM-65F Infrared-Guided Maverick on SMS Page

### Weapons Practice - AGM-65F Maverick Practice

#### *How to Employ the AGM-65F*

1. Master Arm to ARM and Master Mode switch to A/G
2. Select MAVF from the SMS page
3. Set TDC control to the Maverick page
4. Fly to place the triangle on the HUD near the target location
5. Slew the crosshairs over the target on the Maverick display and release the TDC switch to lock the target.
6. Press the weapon release button or **[RAlt] + [Space]** to launch the missile.

When an AGM-65F is loaded on the aircraft, its MAV code is displayed beneath the station is loaded on. The selected station from which to launch the laser-Maverick has the MAVF indication boxed. Selection of the Maverick station can be cycled with the STEP option on pushbutton 13. Beneath each station is the four-digit laser-code that can be edited with the UFC option on pushbutton 14.

MAVF is listed below one of the top pushbuttons (6 to 10) and is boxed when selected. It will be crossed-out when the Maverick has not reached launch criteria, such as tracking a target.

When an AGM-65F is loaded on the aircraft, it is listed below each loaded station on the wingform as MAVF. The selected station is boxed, but the selected station can be cycles with consecutive presses of STEP on pushbutton 13.

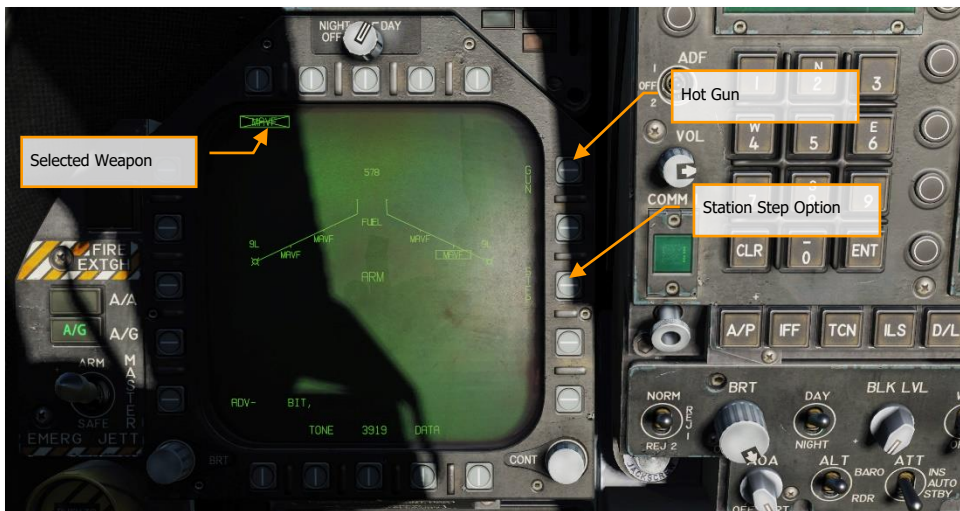

Figure 194. AGM-65F Stores Page

**Station Step Option** -This option is provided when the SMS determines that weapons of the selected type are available for release from more than one weapon station. Each successive selection of the STEP option causes the SMS to change the priority station indication to the next available station in the normal station priority sequence which contains the selected weapon. The station priority sequence for the infrared Maverick is 8, 2, 7, 3

**Selected Weapon.** Below pushbuttons 6 through 10 are listed the weapons detected as loaded. AGM-65F appears as MAVF. If the weapon is not locked to a target, MAVF will be X'd through. Pressing the MAVF will display the AGM-65F weapon format page.

*AGM-65F Infrared Maverick Format Page, TIMING*

If a mission is started on the ground or on the carrier, the AGM-65F will first need to spin up its gyro and cool down its seeker upon takeoff and selection of MAVF from the SMS. Upon which, the TIMING cue will decrement from 3-minutes. During this period, no video is displayed to the MAVF format page. Once the 3-minutes period has elapsed, Maverick symbology is displayed on the DDI.

If you were to land and re-arm with AGM-65F Mavericks, this timing period would need to be repeated.

If a mission starts airborne, the timing will have already been accomplished.

Elements of the MAVF page while in TIMING mode include:



Figure 195. AGM-65 Format Page

**Station Select.** The IR Maverick can be carried on stations 2, 3, 7 and 8. The weapon station selected by the SMS is indicated beneath the weapon selection status. The priority sequence is 8, 2, 7 then 3.

**TIMING Cue.** When the infrared Maverick weapon is selected, the SMS applies power (AGM-65 Select signal) to all LAU-117A(V)2/A launchers attached to IR Mavericks and provides a timing signal to the MC for display on the Maverick format. To ensure that the IR Maverick is ready for launch, the SMS sends a 3-minute countdown timer to the MC, which is displayed as an advisory cue, "TIMING ##". The time ## decrements from 180 seconds to allow for worst-case gyro spin-up time and is removed at 0 seconds.

**Fuzing Options.** Three mutually exclusive fuzing options, instantaneous (INST) and two delay (DLL1, DLL2) options, are selectable for IR Maverick electrical fuzing control. The selected fuzing is provided to the SMS for electrical fuse control via the AN/AWW-4(V) Fuse Function Control Set.

**Ship Track.** Selection of this option will set the Maverick seeker guidance and control to optimize for a ship target and offset the impact point to the ship's waterline. The Maverick horizontal tracking gate will widen to twice the length of the vertical tracking gate while the Maverick is in "SHIP TRACK" mode and is not in the TRACK mode.

**Tracking Polarity.** Track polarity is indicated by the label displayed at this option. While the missile not in Track mode, either "TRACK WHT", or "TRACK BLK" may be selected. The Maverick composite video is only displayed in White Hot mode. Therefore, when the display indicates "TRACK WHT", the missile will track on the hot (white) target when it is commanded to track. When the format indicates "TRACKL BLK", the missile will track on the cold (black) targets. The missile will reflect the selected tracking polarity by displaying the Maverick crosshairs and the pointing cross in either back for "TRACK BLK" or white for "TRACK WHT". The tracking polarity will initially be set to "TRACK WHT" (hot on cold). The TRACK option will not be displayed Forced Correlate track is selected.

**Caged/Uncaged Status.** The caged/uncaged status of the weapon is continuously provided on the Maverick format. when the weapon is initially selected with no existing designation, CAGED is displayed. When an uncage signal is commanded to the missile by depression of the CAGE/UNCAGE button on the right throttle, UNCAGED is provided on the format. The Maverick will automatically uncage if the TDC is depressed or if a waypoint is designated as a target.

**Station Step (STEP)** -This option is provided when the SMS determines that weapons of the selected type are available for release from more than one weapon station. Each successive selection of the STEP option causes the SMS to change the priority station indication to the next available station in the normal station priority sequence which contains the selected weapon. The station priority sequence for the Laser Maverick is 8, 2, 7, 3.

**Field of View.** The IR Maverick will place four corner brackets within the wide FOV indicating what area will be encompassed in narrow FOV. The corner brackets are not displayed in narrow FOV. The IR Maverick will initialize to wide FOV. While the IR Maverick is not in Track mode, the FOV (FOV) options can be toggled via two methods. The FOV can be changed by selecting the FOV option on the Maverick display page, or by the throttle outboard switch (HARM Sequence/FLIR FOV/Raid).

## AGM-65F Infrared Maverick Format Page

Once the TIMING has been completed after 3-minutes, infrared video is displayed on the MAVF format page. To slew the MAVF seeker, the TDC must be assigned to the DDI that is assigned the Maverick format page. To do so, move the Sensor Control Switch in the direction of the DDI assigned to the Maverick. Upon TDC assignment, the TDC-control diamond is displayed in the top right corner of the Maverick format.



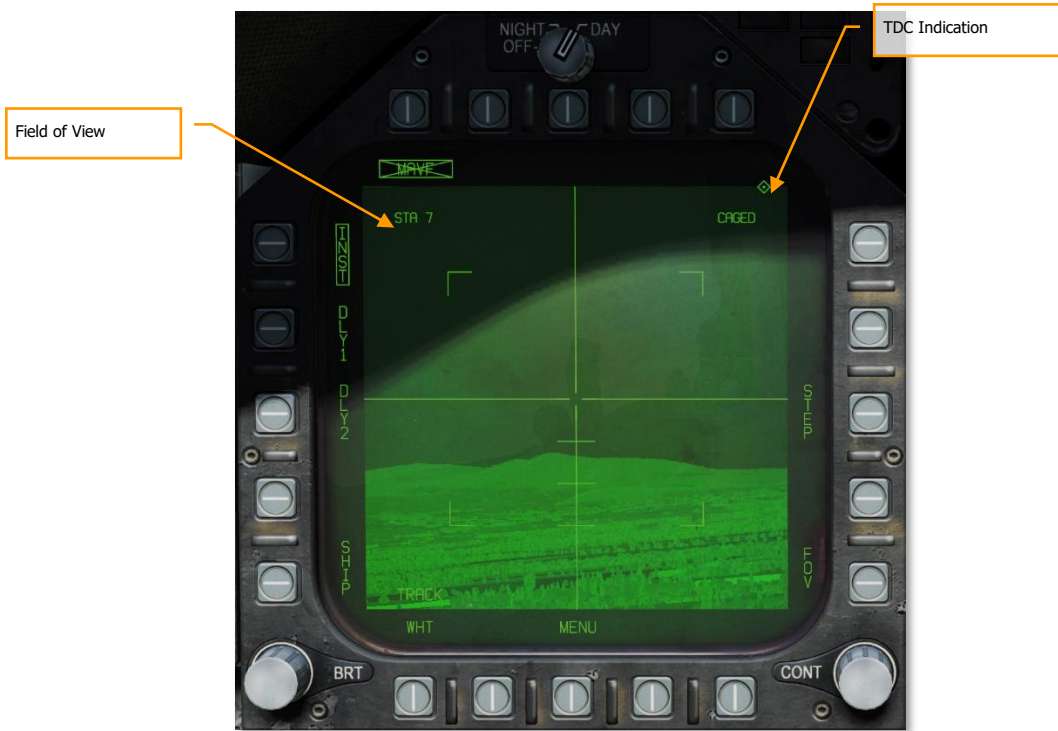

Figure 196. AGM-65F Video

**TDC Indication.** This diamond-shaped symbol appears in the upper right corner of the display whenever the TDC is assigned to the IR Maverick.

**Field of View.** The IR Maverick will place four corner brackets within the wide FOV indicating what area will be encompassed in narrow FOV. The corner brackets are not displayed in narrow FOV. The IR Maverick will initialize to wide FOV. While the IR Maverick is not in Track mode, the FOV (FOV) options can be toggled via two methods. The FOV can be changed by selecting FOV option on the Maverick display page, or by the right throttle's FLIR/RAID FOV button. Press **[I]**.

## AGM-65F Infrared Maverick Targeting

With the TDC assigned to the Maverick format page, the seeker may be slewed within the gimbal limits of the seeker. This can be done in one of two ways based on the selection of the Options / Special Tab / F/A-18C: Realistic TDC Slew option.

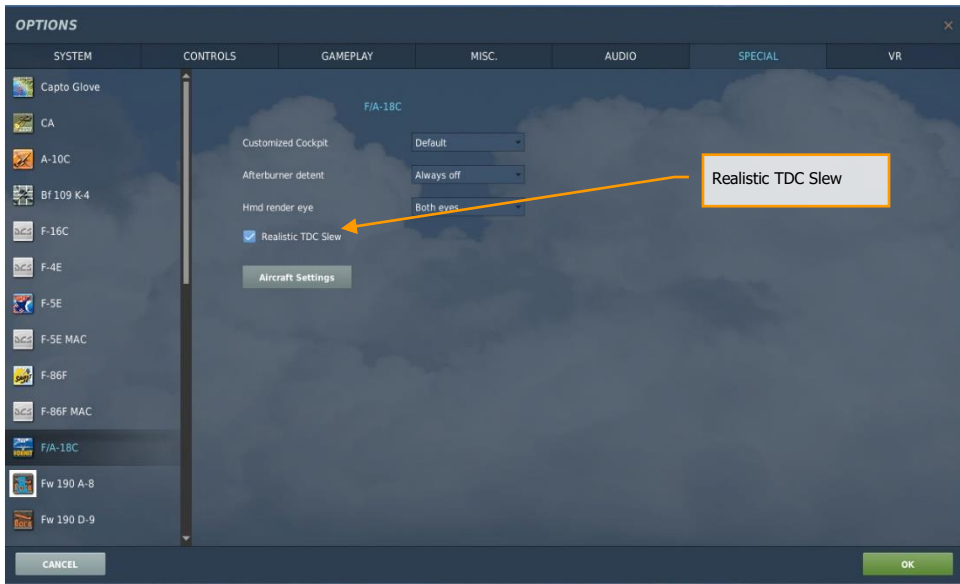

Figure 197. OPTIONS/SPECIAL TDC Slew

- Realistic TDC Slew Option Enabled.** To slew the seeker with the TDC, the TDC must be depressed **[Enter]** while at the same time slewing the seeker **[,]**, **[.]**, **[/]**, and **[;]**. Slew the crosshairs in the center of the display over the desired target and release the TDC switch depress to command a lock of the target. If successful, the crosshairs will collapse around the target and track it in stabilized mode. If unsuccessful, the seeker will not lock and go to break lock mode in which the crosshairs expand.
- Realistic TDC Slew Option Disabled.** Some controllers may have difficulty recognizing multiple inputs at once. If you have trouble with the realistic option, please disable it and try this. Instead of requiring the TDC to be depressed while slewing the seeker, you can instead simply slew the seeker with **[,]**, **[.]**, **[/]**, and **[;]** with no TDC depress. Slew the center of the crosshairs over the desired target and cease slew movement. Wait up to two seconds to allow the seeker to lock on to the target. If successful, the crosshairs will collapse around the target. If unsuccessful, the crosshairs will expand out.

When slewing the seeker, the center of the vertical horizontal bars (crosshair) marks the location where the seeker will attempt to lock a target. When slewed off boresight, the pointing cross provides a reference of the seeker line of sight offset from boresight.

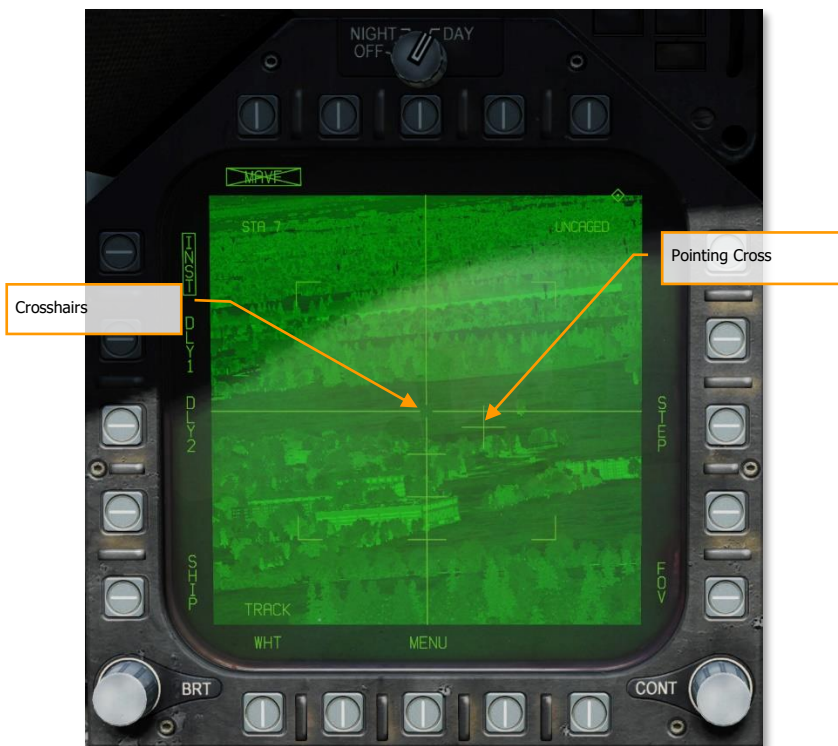

Figure 198. AGM-65F Track Video

**Pointing Cross.** The seeker position will be indicated by a small pointing cross. The pointing cross position relative to the large crosshairs will indicate the seeker position. Relative to missile boresight the tick marks along the vertical crosshair are spaced by  $5^\circ$ , thereby indicating the depression angle and the scale. When the IR Maverick is in track and either the target is not within the launch constraint window or the tracking performance is poor, the small pointing cross will flash. A steady pointing cross will indicate a good lock.

### *Slave Maverick to Target (TG)*

In addition to manually slewing the seeker to locate and lock onto a target, the seeker may also be slaved to a target (TGT). This could be a waypoint designated target (WPDSG) or a target created with a sensor. With a TGT created, the Maverick seeker will automatically uncage and slew to the target location. To slew the seeker away from the designated target location, press the Undesignate [S] button to allow manual slew.

On the HUD, we have indications for the Maverick line of sight and the status of the seeker tracking.



Figure 199. AGM-65 HUD

**Seeker State.** With the AGM-65F selected, MAVF is displayed along the right side of the HUD with an X through it, indicating it is not in track mode.

**Seeker Line-of-Sight.** This triangle on the HUD indicates the seeker line-of-sight through the HUD. This can be a useful cue to visually slew the seeker to the target location.

## AGM-65F Infrared Maverick Tracking

Once the Maverick seeker has locked to a target, new information is presented on the Maverick format and the HUD.

On the HUD, the triangle line-of-sight indicator will be stabilized to the target location and the MAVF indication will no longer have an X through it.

On the Maverick format page, RDY will be displayed below the MAVF weapon indication, and the crosshairs collapsed on the target.

Pressing the weapon release button or **[RAlt] + [Space]** will launch the missile. Once launched, the video will cease from the missile just fired and move to the next Maverick in priority if one is loaded.



Figure 200. AGM-65 Video and HUD

# AGM-88 HARM

The AGM-88C High-Speed Anti-Radiation Missile (HARM) is an air-launched weapon that homes in on and destroys radar emitters. This is most often used to suppress and destroy Surface-to-Air Missile (SAM) units to allow other air units to enter a contested area. The HARM replaced the older AGM-45 Shrike with faster speed, longer range, a larger warhead, and more capable guidance.

The HARM can fly at speeds exceeding Mach 2 by means of low-smoke solid rocket booster. Depending on the launch altitude, the HARM can reach targets out to 80 nm. Behind the Texas Instruments passive seeker is a WDU-21/B blast fragmentation warhead. The warhead is armed with a proximity device that allows the warhead to detonate near the radar antenna dish to increase the fragmentation area.

The HARM can be employed in three modes:

- Self-Protection (SP) with Pull Back option
- Target of Opportunity (TOO)
- Pre-Briefed (PB)

## Loading

The HARM is suspended from the LAU-118/A launch rail, which is connected to BRU-32/A pylons. Four HARMs can be loaded on stations 2, 3, 7, and 8.

## HOTAS

Momentary pushbutton switch which controls the forward looking infrared (FLIR) field of view (FOV). Switch controls high speed anti-radiation missile (HARM) target sequencing [I]. Switch output is a discrete input to the armament computer. When pressed, provides manual stepping of HARM priority targets by way of the command launch computer with HARM weapons selected.

## HARM Select

With A/G or NAV Master Mode selected, no weight on wheels, and at least one HARM loaded on the aircraft:

1. On the AG SMS page, HARM is selected via the pushbutton (6 to 10) on the with the legend "HARM". At that time, the HARM format is displayed by replacing the SMS page.
2. On the TAC page, the "HARM DSPLY" legend is displayed below pushbutton 9. Upon selecting HARM from the TAC page, the HARM format page is displayed.



*Figure 201. TAC Page*

When the HARM is selected in either manner, it will first default to the Self-Protect (SP) mode or the last selected mode. From the SP mode, the other two modes can also be selected: Target of Opportunity (TOO) mode and Pre-Briefed (PB) mode.

On the SMS page, the HARM wingform station will indicate "STBY" if no target has been handed off (H-OFF) to the missile. Once the selected HARM missile has been handed off to a target, the indication changes from "STBY" to "RDY".

After launch, the next HARM missile in priority is selected automatically. The weapon priority list is: 8 → 2 → 7 → 3



Figure 202. SMS Page

**Weapon Select.** When at least one AGM-88 is loaded, HARM will appear below pushbuttons 6 to 10. Pressing the HARM pushbutton will box the legend and display the HARM format page.

**Station Indicator.** HARM is listed below each station that a HARM is attached to. The selected HARM to launch next is boxed.

**HARM Status.** The launch status of the selected (boxed) HARM is indicated below the station indicator. This can be either STBY or RDY. When the selected HARM is handed off to a target and ready to launch, RDY is displayed.

**HARM Override.** When boxed, the self-protect pullback mode is inhibited. When unboxed, self-protect pullback mode will activate when a critical threat is detected. Boxed by default. See Self-Protect Pullback Mode, below.



## Self-Protect (SP) Mode

### Weapons Practice - AGM-88C HARM

#### *How to Employ the AGM-88C HARM in SP Mode*

1. Master Arm to ARM and Master Mode switch to A/G
2. Select HARM from the SMS page
3. Press HARM Sequence [I] to select / cycle detected radar emitters
4. With threat emitter boxed on EW Page or EW HUD, press the Weapon Release Button [RAlt] + [Space] to launch the missile



Figure 203. HARM SP SMS Format

**Mode Select.** Pushbuttons 3, 4, and 5 are mutually exclusive and used to select the HARM mode. Selecting a mode boxes the legend and an X through the legend indicates that the mode is not available.

**Station.** The station number of the selected HARM.

**STEP.** Successive presses of pushbutton 13 cycles through all stations loaded with a HARM.

**RSET.** Pressing pushbutton 15 cues the HARM to the highest radar threat.

### Threat Selection and HUD Indications

If there is more than one lethal or critical SAM or AAA threat detected, pressing and releasing the HARM Sequence button [I] on the throttle allows the player to cycle through them. Re-select the highest threat emitter by pressing pushbutton 15 (RSET) or the Cage/Uncage Button on the throttle.

The selected radar target on the EW displays is indicated as having a box around it. There is no locked target indication on the HARM format page in SP mode.

Once the HARM is launched toward the selected SP target, the next HARM in priority sequence is automatically selected and default to the highest priority threat.

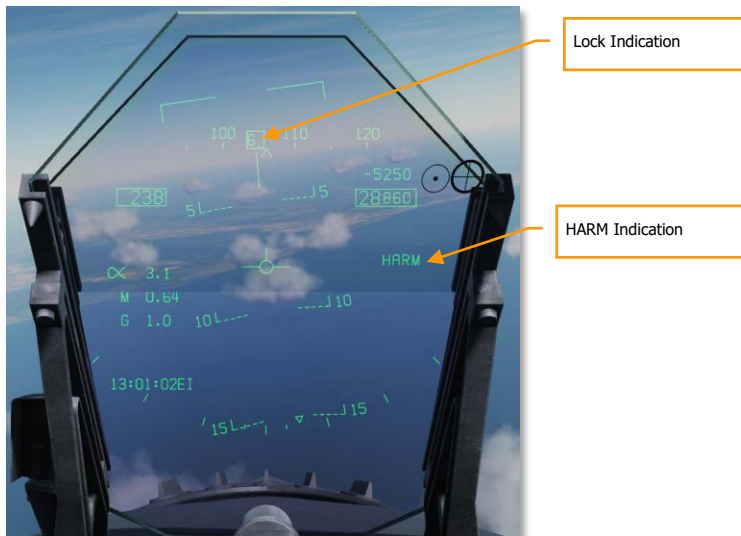

Figure 204. HARM SP HUD

**Lock Indication.** When the HARM has been cued to an EW detection, a box is drawn around the EW emitter code on the HUD, EW Page, and Azimuth Indicator.

**HARM Indication.** When HARM is selected, HARM is displayed along the right side of the HUD.

### Self-Protect Pullback Mode

When the RWR detects a critical threat (either a tracking radar lock, active missile radar lock, or semiactive radar illumination), the Self-Protect Pullback mode will automatically select and prepare a HARM for launch against the detected threat. Note that this functionality is inhibited by default and must be enabled by unboxing the HRM OVRD option on the Stores format.

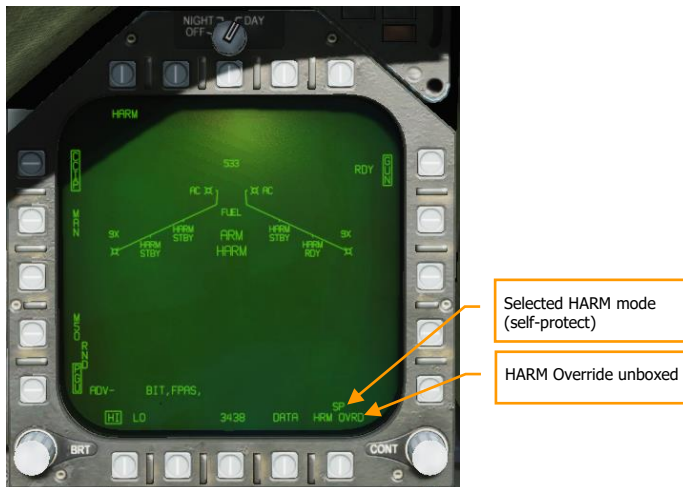

Figure 205. HRM OVRD inactive, Pullback mode active

With HRM OVRD unboxed and a critical threat detected, Pullback mode will activate, and the text "HARM" will appear on the HUD and Stores format. If "HARM" is displayed with no X, then pressing the pickle button will immediately launch a HARM against the threat.



Figure 206. "HARM" displayed on Stores page and HUD.

The "HARM" label will be crossed out if the missile is not ready for launch (not powered on, MASTER ARM off, etc.).



Figure 207. "HARM" Label Crossed Out.

Pullback mode will activate regardless of master mode (A/A or A/G) if the HRM OVRD option is unboxed. If in A/A mode when Pullback is activated, a trigger press will still launch the selected air-to-air weapon.

If the HRM OVRD option is boxed, and Pullback mode is disabled, the text "PLBK" will be displayed instead, and no change will be made to the selected weapon.



Figure 208. "PLBK" label displayed when Pullback is inhibited.

### Notes

- Because the HARM has no ranging capability and is not slewed with another sensor in SP mode, there is no range to target provided.
- The HARM is best used at 30,000 feet AGL and above to maximize range.
- If the targeted radar turns off, the HARM will lose guidance and will likely not hit the target.

## Target Of Opportunity (TOO) Mode

### Weapons Practice - AGM-88C HARM

#### *How to Employ the AGM-88C HARM in TOO Mode*

1. Master Arm to ARM and Master Mode switch to A/G
2. Select HARM from the SMS page
3. Set TDC to the HARM format page
4. Press **[I]** to select / cycle detected radar emitters
5. Hand-off target to HARM by pressing Cage/Uncage button or **[C]**
6. With threat emitter boxed on EW Page or EW HUD with H-OFF indication, press weapon release button or **[RAlt] + [Space]** to launch the missile

Unlike SP mode in which targeting is automatic, TOO mode allows the pilot to select a specific target radar, based Class and Type filtering.

The HARM acts as its own sensor and can display up to 15 targets on the TOO HARM display (format). To select a target, the player can cycle through displayed targets via the HARM Sequence button **[I]** on the throttle. This is indicated as a box around the target. Once the target has been selected, pressing the cage/uncage button **[C]** is used to hand off the Target to the HARM, indicated at a H-OFF above to the Target box. A second press of the cage/uncage button cancels the hand off.

With the target in hand-off, all other Targets on the HARM TOO display are not displayed.

With a correct hand off, the HARM on the SMS wingform will change from STBY to RDY and the X through the HARM indication will be removed.

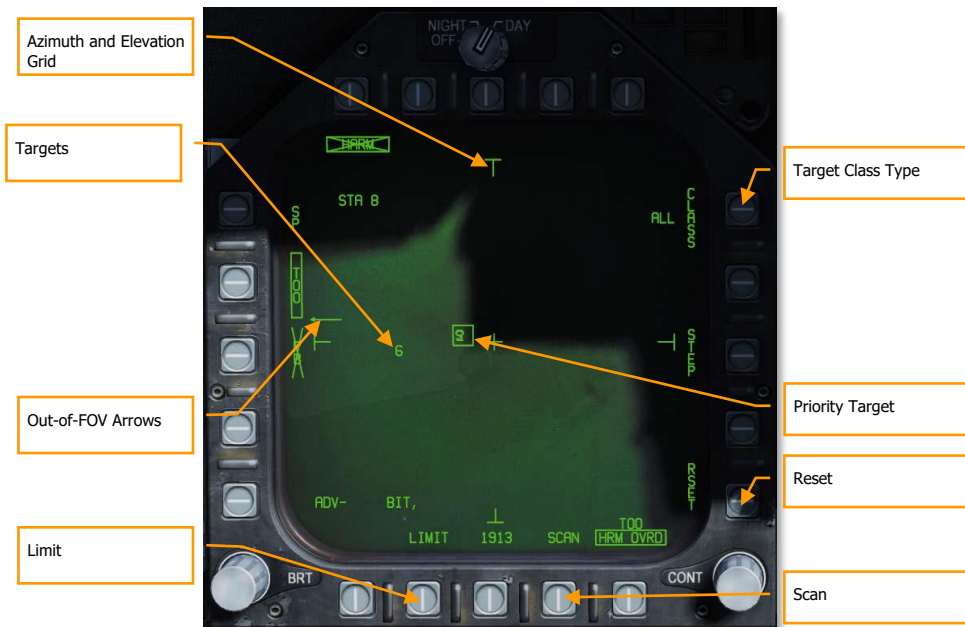

Figure 209. HARM TOO SMS

**Out-of-FOV Arrows.** When targets are detected outside the field of view of the HARM TOO display, arrows are displayed that point in the direction of the unseen targets. Arrows are only at the up, down, left, and right locations.

**Azimuth and Elevation Grid.** These four "T" markers mark the 30° field of view in azimuth and elevation and are placed near the left, right, top, and bottom of the TOO display.

**Targets.** All detected targets of the selected target class are displayed in the TOO display as numeric identifiers. Targets are *not* space stabilized are in reference to the HARM seeker FOV. An "F" preceding a numeric indicates a friendly radar. A half-circle below a target indicates a naval radar, and a horizontal line above the numeric indicates a radar that has locked the player aircraft.

**Limit.** When selected and boxed, only the 5 highest priority targets are displayed instead of 15.

**Scan.** When selected and boxed, the HARM Scan sub-level page is displayed and allows the player to view all Classes on the TOO display.

**Reset.** When pressed, the highest priority target will automatically be selected. This will cancel a target handoff.

**Priority Target.** The priority target has a box around it, and the priority target can be cycled using the HARM Sequence switch on the throttle. This will initially default to the first target detected of the selected target type.

**Target Class Type.** To the left of the CLASS legend, the Class selection is indicated from the Scan sub-level page. TT in the image below. When pressed, the Type sub-level page is displayed.



Figure 210. HARM TOO as Sensor

### TOO HUD

When a target has been designated on the HARM TOO display, a line of sight to the target box is displayed on the HUD. Once the target is handed off to the HARM, H-OFF appears above the box. A second press of the cage/uncage button [C] cancels the hand off.

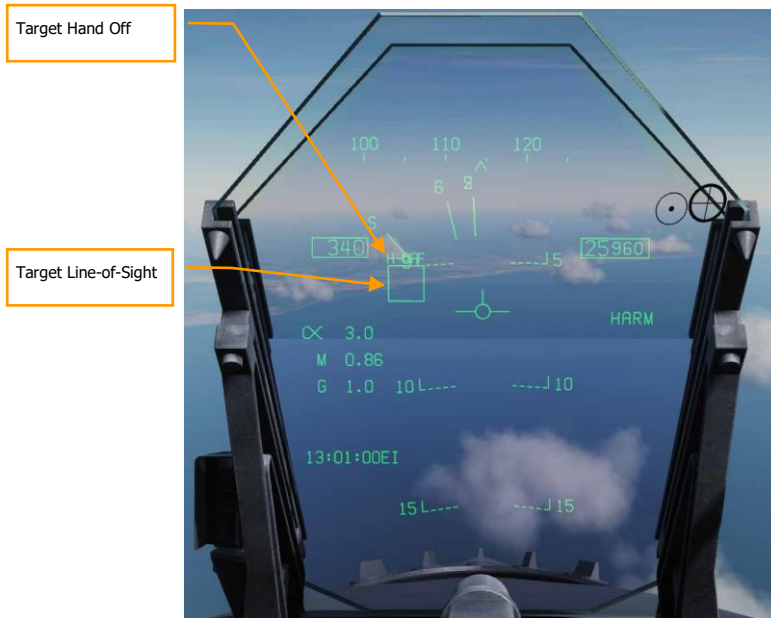

Figure 211. HARM TOO HUD

### *EW Indication*

When a Target has been designated, the Target symbol on both the EW DDI page and the EW HUD will also have a box around the indication.

### *Class Sub-level Page*

The Class sub-level page (pushbutton 11) allows the player to filter the Class of targets that are displayed in the TOO display. From the right, top, and left DDI pushbuttons, the player can select any of these. When one is selected, the page is automatically changed back to the TOO page with the selected Class code is displayed to the left of the Class legend.

On the Class page, all detected targets of all classes are listed as filled circles and their Class code is displayed to the left. If the target is right or left of the HARM FOV, arrows are drawn to show the direction of the target outside the HARM FOV.





Figure 212. HARM Classes

- Class Legend. Indicates the selected Class.
- Class Selections. Along the left, top, and right DDI pushbuttons are 15 Class selections. These are each two or three-digit codes. DCS uses the following substitutes:
  - ALL. All classes of radars
  - FRD. Friendly radars
  - HOS. Hostile radars
  - FN. Friendly naval radars
  - HN. Hostile naval radars
  - F1. Old friendly radars
  - F2. New friendly radars
  - H1. Old hostile radars
  - H2. New hostile radars
  - FAA. Friendly AAA
  - HAA. Hostile AAA
  - FS. Friendly search radars
  - HS. Hostile search radars
  - UKN. Unknown radars
  - PRI. Radars locked to player aircraft

Each Class can have multiple radars that fall within the Class. For a list of classes that apply to each radar, see **Fehler! Verweisquelle konnte nicht gefunden werden.**

### Scan Sub-Level Page

When Scan is boxed from pushbutton 17, the Scan sub-level page is displayed. This will display all Classes and each Class that is currently being detected by the radar warning receiver. Each detected class is indicated by a filled circle with its class code to the right. If the Class is detected outside of the HARM field of view, then arrows will be to the left or right of the filled circle to indicate off-FOV direction.



Figure 213. HARM SCAN

As with the Class sub-level page, the user can also select a Class from this page. In so doing, it will also revert to the HARM TOO page.

Pressing the Scan button will return the display to the TOO page.

## Pre-Briefed (PB) Mode

### Weapons Practice - AGM-88C HARM

#### *How to Employ the AGM-88C HARM in PB Mode*

1. Master Arm to ARM and Master Mode switch to A/G
2. Select HARM from the SMS page
3. Box "PB" on the HARM format to enable PB mode (pushbutton 3)
4. Press "UFC" on the HARM format (PB 14).
5. On the UFC, select line 4 (TGT), enter the three-digit code for the emitter type, and press ENT.
6. Select either aircraft pull-up (PB 2) or HARM pull-up (PB 1).
7. Select and designate the waypoint over the target location.
8. Press and hold the weapon release button or **[RAlt] + [Space]** while following the HUD cues. When the FPM intersects the launch cue within 1° of the azimuth steering line, the missile will launch.

Pre-briefed mode is used when the location of the enemy emitter is known, and a waypoint has been placed in the vicinity of that location. In pre-briefed mode, the missile will loft and fly to the location of the emitter, then turn on its receiver and home on the target.

Activate pre-briefed mode by boxing "PB" (pushbutton 3) on the HARM format. The pre-briefed mode symbology will be displayed.

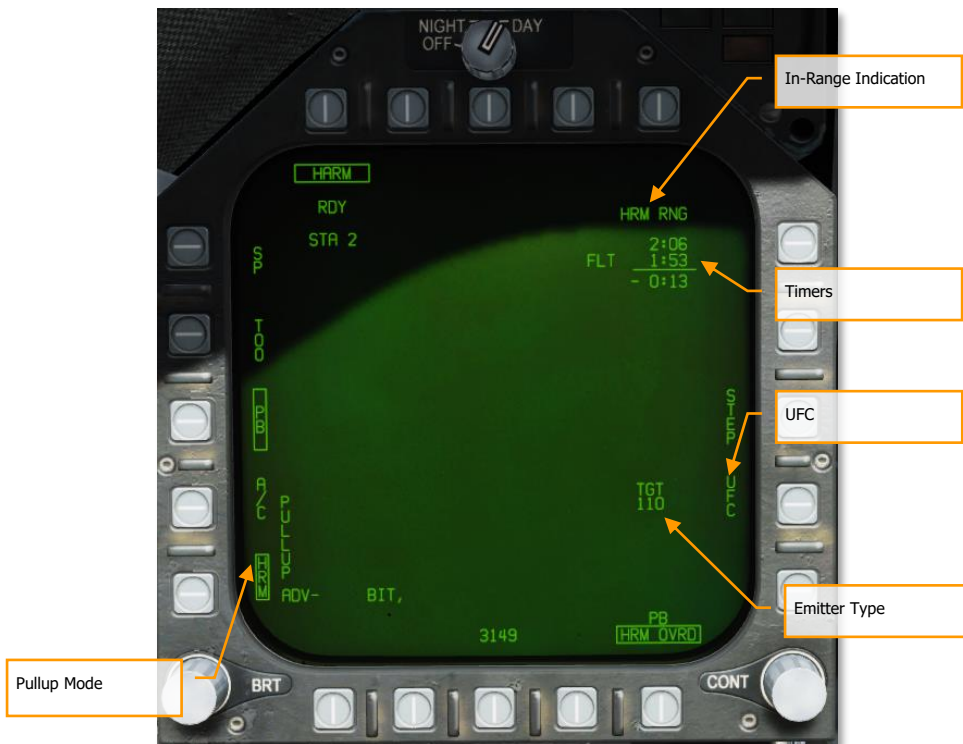

Figure 214. HARM Pre-Briefed Mode

**Pullup Mode.** When "HRM" is boxed, the HARM will do all maneuvering (including lofting) to reach the target. The aircraft will have to be close enough that the HARM will have sufficient energy to do all the necessary maneuvering. When "A/C" is boxed, it is expected that the pilot will perform the loft maneuver, increasing the HARM's range.

**In-Range Indication.** Displays "A/C RNG" when the aircraft is in-range for an A/C pullup shot. Displays "HRM RNG" when the aircraft is in-range for a HARM pullup shot.

**Timers.** The top line displays the time-of-flight of the next HARM, if launched now. The second line displays the time-to-impact of the in-flight HARM. The bottom line displays the difference between the two; in other words, how much later the second impact would be after the first.

**UFC.** Pressing this pushbutton allows the pilot to set the emitter type on the UFC.

**Emitter Type.** Displayed once an emitter type has been set. Emitter types are listed in **Fehler! Verweisquelle konnte nicht gefunden werden.**

Initially, with no target type set, the HARM moniker will be crossed out and no launch will be possible. The pilot must first enter a target type before HARMs can be employed in pre-briefed mode.

To enter an emitter type, press the "UFC" pushbutton (PB 14), and select line 4 on the UFC:



Figure 215. HARM PB UFC options

After selecting line 4, enter the 3-digit emitter type code and press ENT.

After entering a target type and choosing a pullup mode, use the HSI format to select the waypoint at or near your target location, and box "WPDSG" to designate it. You should then see the timer block at the upper-right. The HUD will provide steering cues to the launch zone.

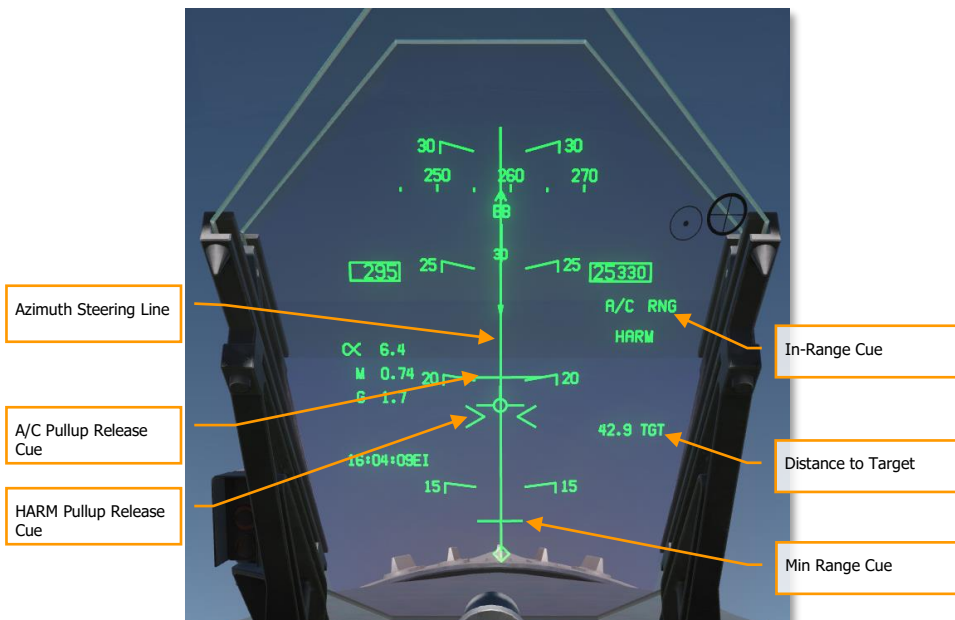

Figure 216. HARM PB HUD symbology

If you are performing an aircraft pullup, fly towards the target according to the azimuth steering line (ASL) until "A/C RNG" appears on the HUD and DDI. Then, begin your loft maneuver. While holding down the Weapon Release button, raise the nose to 45° and climb until the flight path marker intersects with the A/C pullup release cue. Once it does, the HARM will come off the rail. You can release the Weapon Release button at this point.

If you are performing a HARM pullup, fly towards the target according to the ASL until "HRM RNG" appears on the HUD and DDI. Then press and hold the Weapon Release button. Raise the nose until the FPM intersects with the HARM pullup release cue. (A small amount of loft may be required.) The HARM will come off the rail, and you can release the Weapon Release button.

The missile will not fire unless the FPM intersects with the appropriate range cue and the flight path marker is within 1° laterally of the azimuth steering line.

When the FPM intersects the min-range cue, the aircraft is too close to the target. The HARM missile will not be able to perform the required pull-down to reach the target.

# AGM-84D HARPOON

The AGM-84D Harpoon is the primary anti-ship weapon for the F/A-18C. It is a big, heavy weapon with a large warhead, sophisticated guidance system, and a long range. It has two primary release modes: Range / Bearing Launch (R/BL) and Bearing Only Launch (BOL). R/BL is the most accurate of the two but requires you to know the bearing and range to the target before firing. This is done using the SEA mode of the radar on AG mode. BOL is a less accurate, but you only need to know the approximate bearing of the target. For this initial release of the Harpoon, BOL will be available. Once the SEA mode of the radar is ready, we will add R/BL mode.

The weapon release button **[RAIt] + [Space]** is used to launch a Harpoon.

## Harpoon SMS Format

Upon selection of the AGM-84D Harpoon from the top row of the SMS page, the Harpoon format page is displayed. Options this page will vary based on BOL or R/BL mode and if a Harpoon Turnpoint (HPTP) is used.

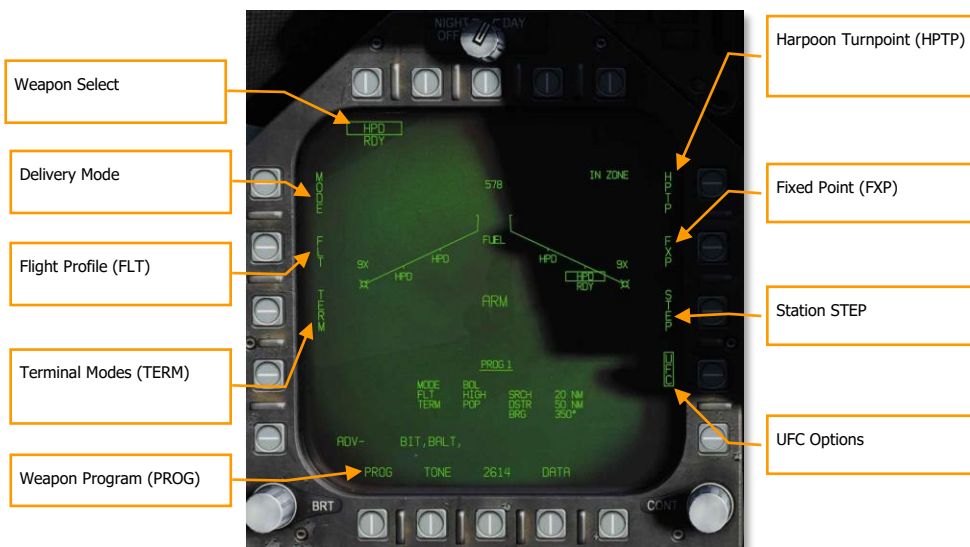

Figure 217. Harpoon Main Page

The unique and primary functions of the page are:

**Weapon Select.** Harpoons are listed as HPD and will first have a 20-second TIMING cue when first selected. Once the 20-second count-down has expired, RDY is displayed below the HPD indication. Prior to being ready, the boxed HPS will have an X through it.

**Delivery MODE.** There are two modes that the Harpoon can be fired in:

- BOL. Bearing Only Launch (BOL) allows the missile to be launched and fly along a set bearing and the missile will attempt to search for ship targets according to the set criteria.
- R/BL. Range / Bearing Launch (R/BOL) requires a ship target to first be designated (using A/G radar SEA mode).

**Flight Profile (FLT).** The FLT option provides three flight profiles, HIGH, MED, and LOW. These are used to change the flight profile setting.

- HIGH: The Harpoon cruises to the target at high altitude. A high-altitude profile provides the maximum range for the weapon and increases the effective search area of the seeker; however, the weapon is detectable at longer range and more susceptible to countermeasures. Cruise altitude is 35,000 feet.
- MED: The Harpoon cruises to the target at medium altitude. Medium altitude provides a compromise between the HIGH and LOW profiles. Maximum range and search area is greater than LOW, but less than HIGH. Similarly, enemy detection typically occurs later than HIGH, but sooner than LOW. Cruise altitude is 15,000 feet.
- LOW: The Harpoon cruises to the target at low (sea skimming) altitude. Low altitude is also known as a sea skimming profile because the Harpoon travels to the target area at very low altitude. While maximum range is reduced, enemy reaction time is also greatly reduced. Cruise altitude is 5,000 feet.

**Terminal Modes (TERM).** Two terminal mode options, SKIM and POP, are available. These are used to change the terminal mode option.

- SKIM: After acquiring a target with its onboard radar, the Harpoon flies a minimum altitude approach to the target (25 feet).
- POP: After target acquisition, the missile commences a pop-up attack on the target. This begins at 5 nm from the target and climbs to 500 feet before diving on the target.

**Seek Mode (SEEK).** This is only available in R/BL mode and not pictured above. Upon pressing SEEK, three options are presented that determine when the seeker begins searching for the target at the designated location:

- SML. 10,000 meters before target location
- MED. 20,000 meters before target location
- LRG. 30,000 meters before target location
  - LEFT
  - RIGHT
  - NORM
  - NEAR
  - FAR

This will offset the search based on the selection.

**Harpoon Turnpoint (HPTP).** Allows the selection of a waypoint or markpoint to be used as an intermediate turnpoint between ownship and the target/search area. With a turnpoint selected, the Harpoon will first fly to the turnpoint, then turn towards the final bearing (BOL), or target (R/BL). Boxing the HPTP option copies the currently selected (via HSI) waypoint/markpoint into the selected Harpoon delivery program. To change the turnpoint, the HPTP option is unboxed, the waypoint is changed via the HSI, and then the HPTP option is re-boxed. The HPTP option is applicable to both the R/BL and BOL modes, however in BOL mode, the search distance becomes relative to the turnpoint rather than ownship. If a HPTP is selected in BOL mode, the Fixed-point option is blanked, since the two modes are incompatible.



**Fixed-Point (FXP).** The Fixpoint option allows the ability to fix the search pattern of the BOL mode about a NAV stabilized mid-point. The mid-point is located halfway between the search and destruct ranges. This essentially creates a fixed derived "target" area allowing multiple Harpoons to be deployed into the same area without an actual designated target. The fixpoint option is not available when a turnpoint (HPTP) is selected.

**Station STEP.** Actuation of the Step PB cycles through loaded Harpoons on the wing stations. A selected and TIMED Harpoon will have its HPD label boxed on the wingform with RDY below. Non-selected stations are not boxed and have STBY below.

**Weapon Program (PROG).** This option cycles between the available programs in sequence. You can modify the current program by using the MODE, FLT, TERM, SEEK, SRCH, and BRG settings. There can be up to five programs and each Harpoon can be set to a different program.

**TTMR.** The Time to Maximum Range (TTMR) is displayed only in R/BL mode when the target is locked and indicates time remaining until the target will be at maximum launch range. When target is within maximum range, the TTMR is replaced with IN ZONE. This is displayed in the top left corner of the Harpoon format page.

### UFC Options



Figure 218. Harpoon UFC Options

**Active Search Range (SRCH):** (BOL mode only) This option adjusts the range from the launch point that the Harpoon begins its active search. To adjust, the player will press the UFC pushbutton and then select the SRCH button on the UFC. The player can then enter a value on the keypad and then press the UFC ENT button to save it. Valid search range is from 0 to 105 nm.

**Missile Destruct Range (DSTR).** Upon selection from the UFC Option Select Window, the player can enter a range in nautical miles on the keypad to determine when the Harpoon will self-destruct. Valid range is from the entered search range plus 172 nm.

**Flight Bearing (BRG):** (BOL mode only). As with the SRCH function, the player will select the BRG option on the UFC. The magnetic or true bearing relative to ownship that the Harpoon will launch along. If a Harpoon Turnpoint (HPTP) is selected, the bearing will be relative to the turnpoint. If Fixpoint (FXP) is selected, the BRG will become irrelevant. Valid bearing is 0 to 359.

## Harpoon HSI

Once the search, destruct, and bearing information has been entered the program for a Harpoon, a graphic of its flight plan is displayed on the HSI.

When no Harpoon Turnpoint is selected, the HSI will display a line based on the entered bearing, a small hash mark on the bearing line that indicates the start of the search, and an "X" at its self-destruct point.

With a Harpoon Turnpoint, the bearing, search, and destruct symbols are in relation to the selected waypoint that acts as the Harpoon Turnpoint.



Figure 219. Harpoon HSI page



Figure 220. Harpoon Turnpoint

## Harpoon HUD

When a Harpoon is selected, the HUD symbology reflects the weapon and mode selected.

When BOL mode is selected, only the mode, BOL, and the weapon identification, HPD, are listed along the right side of the HUD. As there is no designated target, there is no TGT indication like range and bearing to target.

If the weapon is with a valid launch zone to reach its programed search and destruction zone, an IN ZONE indication is displayed. If, however, the missile is out of valid launch parameters, an OFF AXIS message is displayed.

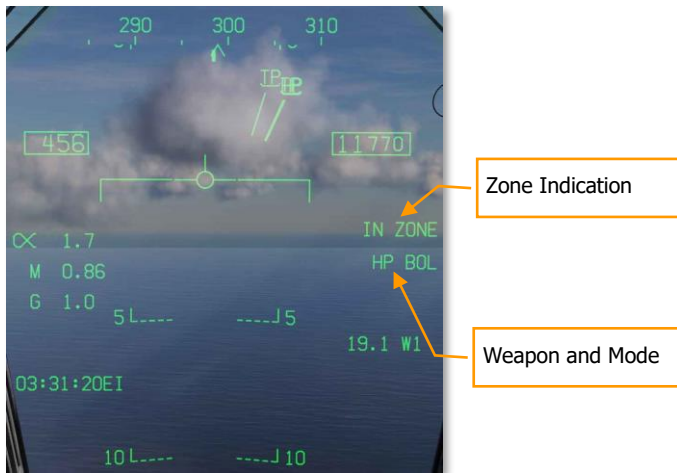

Figure 221. Harpoon HUD

# AGM-84E STAND-OFF LAND ATTACK MISSILE (SLAM)

The AGM-84E SLAM is a derivative of the AGM-84D Harpoon anti-ship missile that is designed for precision attack against fixed ground locations. It is a sub-sonic (0.7 Mach) cruise missile with an operational range of 50 miles that uses INS and GPS navigation. It is armed with the same warhead as in a Tomahawk land attack missile (TLAM). Like the AGM-62 Walleye that preceded it, it interfaces with the AN/AWW-13 datalink pod that allows live video from its AGM-65F seeker to be transmitted to the pilot while the missile is in flight. Using the TDC slew control, the pilot can fly the missile to the target with pinpoint accuracy. Like other GPS-guided weapons of the F/A-18C, the SLAM can be launched in both Pre-Planned (PP) and Target of Opportunity (TOO) modes.

The AN/AWW-13 Advanced Datalink Pod is used to communicate with the SLAM. It allows for guidance of the SLAM seeker after it has been launched by transmitting and receiving post-launch slew and lock-on commands. The AN/AWW-13 provides man-in-the-loop guidance.

The weapon release button **[RAIt] + [Space]** is used to launch a SLAM.

## Weapon Selection

Upon initial weapon selection and timing is complete (2:30), all currently inventoried weapons of the same variant are placed into STBY (standby) status as indicated under their respective weapon acronyms. All weapons simultaneously begin warming up and will remain initialized if at least one weapon station of the same type is selected.

Deselecting SLAM will likewise cause all weapons of the same type to spin down, requiring at least 2.5 minutes for warmup to complete again. Consideration should therefore be given to this warmup cycle when mission planning. The status of this warmup cycle is indicated on the STORES and SLAM formats as a TIMING cue which is initialized to 10:00 minutes and counts down. The TIMING cue is removed when the Time-to-Go (TTG) reaches 7:30 (warmup complete after 2:30).

When a GPS weapon is initially selected, all stations of the same store type are simultaneously placed in STBY until the TIMING cue is removed, at which point the priority station will either remain in STBY or transition to RDY (ready), depending on A/G Ready status (e.g., warmup complete, designation exists and is valid). All additional stores of the same type will remain in STBY until selected (RDY cue), explicitly deselected, or indirectly deselected by the selection of a different weapon type or upon transition to A/A master mode.

## SLAM Stores Format

As with other A/G stores, all GPS weapons including SLAM may be selected in NAV or A/G master modes by boxing the applicable weapon acronym from weapon selection menu across the top row of push buttons from the STORES planform format. It should be possible to program SLAM while on the ground with master arm to SAFE and in NAV master mode.

SLAM is listed as SLAM

Selection of any GPS weapon on the STORES format applies power to every inventoried GPS weapon of the same type. Power remains applied to the GPS weapons until deselected. A GPS variant is deselected only when the associated weapon select option is unboxed explicitly, or another weapon type is selected. When operational power is first applied, warm-up and transfer alignment begin. As soon as warmup is complete (2.5 minutes from initial power up), the weapon may be armed for release. Note that the alignment quality is not a prerequisite for release interlocks and achieving an alignment quality of GOOD may take as long as 10 minutes.

## SLAM and Datalink SMS Page

Because of the possible combinations of loading SLAM and the AN/AWW-13 datalink pod, there are three possible format pages. These formats replace the standard wingform format when selected.

- Only datalink pod
- Only SLAM
- Both datalink pod and SLAM

From the TAC page SLAM DSPLY is available when only at least one SLAM is loaded but not AN/AWW-13 datalink pod. SLAM-13 DSPLY is shown when both a SLAM and the datalink pod are loaded, and DL13 DSPLY when only the datalink pod is loaded.

When both SLAM and the datalink pod are selected, only the top 80% of the displays has video with stroke symbology over the entire display.

### *AN/AWW-13 Datalink Pod Only Selected*

When the datalink pod is selected and a SLAM is not, the top 80% of the display should be static because the datalink pod has not been linked to a SLAM. Elements of the datalink only page include:



1. **Weapon Selection Status.** If the AWW-13 is being used in conjunction with a SLAM, both SLAM and DL13 should be boxed. When conditions do not permit release of a SLAM (e.g., out of LAR), "SLAM" is crossed out.
2. **Pod Antenna Option.** The A ANT option selects the aft antenna of the datalink pod. It is boxed when selected. Although it can be selected, it will have no game function.

3. **Weapon Selection.** The Weapon option links the datalink pod to the selected datalink-capable weapon. When linked, the option is boxed.
4. **TDC Assignment Indication.** This diamond indicates that the TDC is assigned to the display. In order to slew the seeker head, TDC must be assigned to the DL13 format.
5. **UFC Pod Channel Selection Option.** This option is used to select one of the pre-set pod datalink channels. Pressing PB 14 displays CHNL on the top Open Select Window on the UFC. Upon colonizing the window, the channel is entered using the keypad and ENT is pressed. If a valid channel is entered (2, 3, 7 or 8), the channel number is listed after CH on the datalink format. The channel number will correspond to the SLAM station number.

### *SLAM Employment with No Datalink Pod*

When used without the AN/AWW-13 datalink pod, the SLAM acts in a very similar manner to other INS/GPS-guided weapons like JDAM and JSOW, in both TOO and PP modes. The terminal infrared imager cannot be used without a datalink pod.

### *SLAM SMS Format with No Datalink Pod*

Upon selection of the AGM-84E SLAM from the top row of the SMS page, the SLAM format with AN/AWW-13 datalink pod page is displayed.

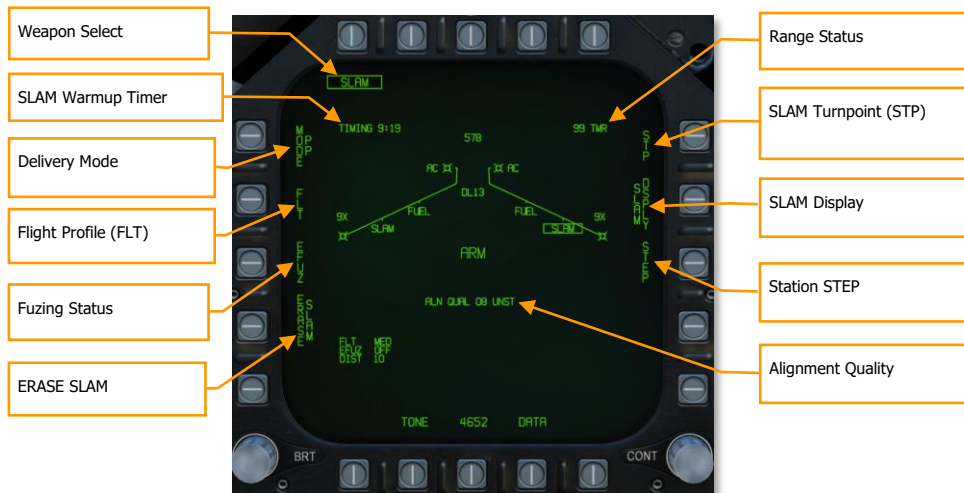

The unique and primary functions of the page are:

**Delivery Mode.** Selects the GPS delivery mode for the priority station.

- Pre-Planned (PP). Instructs the priority weapon to execute the selected pre-planned mission, if valid.
- Target of Opportunity (TOO). Instructs the priority weapon to cue to the sensor-designated target, if any.

**Weapon Select.** SLAMs are listed as "SLAM" and will have a 2 minutes and 30 seconds TIMING cue when first selected. It will start at 10:00 and countdown to 7:30 until GOOD alignment is reached. Once at 7:30, RDY is displayed below the SLAM indication. Prior to being ready, the boxed SLAM will have an X through it.

**SLAM Warmup Timer.** The TIMING SLAM warmup timer cue initializes at 10:00 minutes and counts down to 7:30 when SLAM warmup is complete, at which time the cue is removed.

**Flight Profile (FLT).** The FLT option provides three flight profiles, HIGH, MED, and LOW. These are used to change the flight profile setting.

- HIGH: The SLAM cruises to the target at high altitude. Cruise altitude is 35,000 feet.
- MED: The SLAM cruises to the target at medium altitude. Cruise altitude is 15,000 feet.
- LOW: The SLAM cruises to the target at low (sea skimming) altitude. Cruise altitude is 5,000 feet.

The default Flight Profile setting will be Medium (MED), and the selected Flight Profile is listed in the bottom left portion of the page.

**Fuzing Status.** The EFUZ or MFUZ fuze status cue indicates the armed or safe status of the fuzes for the selected SLAM. The fuze status is displayed in the bottom left corner of the display.

**ERASE SLAM.** This option immediately clears all GPS weapons of the selected variant of all previously entered pre-planned (PP) mission data. SLAM ERASE is boxed when selected and remains boxed for 5 seconds. SLAM ERASE cannot be undone.

**SLAM Turnpoint (STP).** Allows the selection of a waypoint or markpoint to be used as an intermediate turnpoint between ownship and the target/search area. With a turnpoint selected, the SLAM will first fly to the turnpoint, then turn towards TOO or PP target location. Boxing the STP option copies the currently selected (via HSI) waypoint/markpoint into the selected SLAM mid-course guidance program. To change the turnpoint, the STP option is unboxed, the waypoint is changed via the HSI, and then the STP option is re-boxed.

**Station STEP.** Actuation of the Step PB cycles through loaded SLAMs on the wing stations. A selected and TIMED SLAM will have its SLAM label boxed on the wingform with RDY below. Non-selected stations are not boxed and have STBY below.

**Range Status.** The Range Status cues refer to the weapon at the priority station:

- ## TMR. If the aircraft is outside the Launch Acceptability Region (LAR) and the target is within the forward hemisphere of the aircraft, this cue will read ## TMR indicating the time in seconds (99 max) until the aircraft is within the maximum range of the weapon at the current (no launch zone specified), or reference (LZ specified) altitude.
- IN RNG. If the aircraft is within the aerodynamic range of the weapon, but is not yet within the LAR, IN RNG will be displayed here. Generally speaking, and at least in terms of the current simulation, IN RNG will be transient, as IN ZONE will occur almost immediately following IN RNG.
- IN ZONE. This cue indicates the aircraft is within the LAR and the weapon should be released.

**Alignment Quality.** Indicates the priority station navigational state. This is the state of the weapon's internal guidance alignment status. Weapon INS alignment quality takes time to improve. This cue consists of a numeric value from 01 (best) to 10 (worst) and a plain language cue of UNST, MARG or GOOD. All weapons initialize in the 10 UNST state.

- Time 10:00 to 9:15: ALN QUAL 10 to 7, UNST
- Time 9:15 to 8:30: ALN QUAL 6 to 3, MARG
- Time 8:30 to 7:40: ALN QUAL 2 to 0, GOOD

**TTMR.** The Time to Maximum Range (TTMR) is displayed only when a TOO or PP target has been set for the selected SLAM. It indicates time remaining until the target will be at maximum launch range. When target is

within maximum range, the TTMR is replaced with IN ZONE. This is displayed in the top left corner of the SLAM format page.

**SLAM DSPLY.** Selecting SLAM Display changes the SLAM format page to Quantity page.

### *Weapon Quantity and Mission Option Sub-Level*

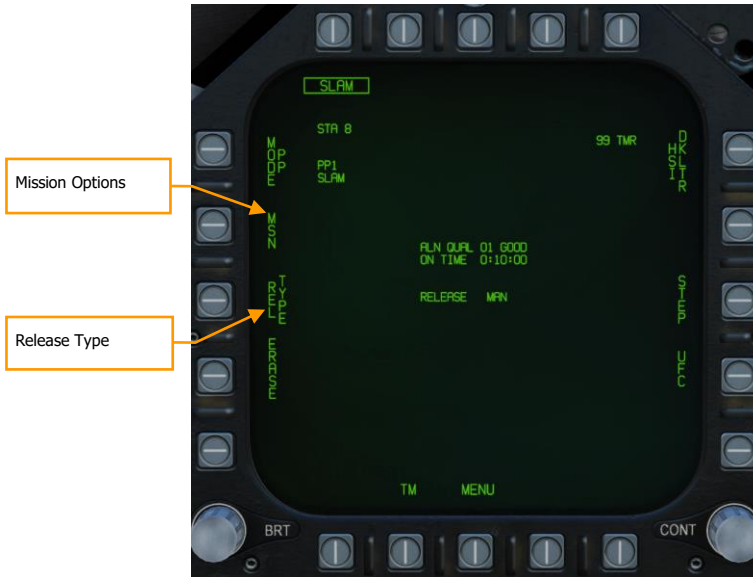

**Mission Options.** This page allows the player to create Target Data Sets (TDS) for the selected SLAM against the selected target. The Mission Data (MSN) format is accessed by pressing the MSN option on pushbutton 4. The Mission Data format is used to select and program one of the 6 available PP missions or a TOO target. A mission is selected by depressing one of the PP# options at [PB6]-[PB11] if PP mode is selected. If in TOO mode, the target is based on designated target location. One of the various UFC options along the lower right side of the format is then selected to begin program data entry. Note that program data may be pre-programmed in the Mission Editor.

**Release Type.** This cue lists the selected release mode for the selected weapon:

- AUTO LOFT: N/I
- MAN: Weapon release is initiated manually by the pilot.
- FD: N/I

### *Pre-Planned Mission Programing Sub-Level*

Once the Mission Option is selected for a PP or TOO attack, the mission programming page is displayed.

Pre-Planned allows entry of specific target coordinates as well as optional offset coordinates and/or Launch Point parameters. These options are combined into what is referred to as a *Pre-planned* (PP) Mission. There is a total of 6 PP missions available for programming and each weapon station may be assigned to any one of these missions. The *Launch Point* (LP) for any given mission is optional and is automatically calculated based on pilot-



entered bearing, altitude, and ground speed. The MC then determines the maximum range of the weapon at the reference altitude and converts the resulting point into LP coordinates. The aircraft is then flown to the LP along the LP bearing line to deliver the weapons at a specific bearing to the target(s). A PP mission is selected by boxing one of the 6 available PP mission pushbuttons located along the top of the MSN display. Unboxing a currently boxed PP mission, selects the TOO mode.



**Mission Identifier.** This area displays the currently selected mission type (PP or TOO), and in the case of a PP mission, the mission index. For example, PP4.

**Target Data.** The target coordinates and elevation for the selected PP mission may be specified via the UFC, and if valid, are displayed here. They may also be set as a preplanned target created in the Mission Editor. If the target is an OAP (an offset was specified), the *TGT* label becomes *OAP*, and the *OAP* relative bearing and distance are displayed to the right of the *OAP* data area. The latitude and longitude of the target are displayed in this data block, as well as target elevation.

**Target Data UFC Format.** Upon selecting the Target Data UFC Entry pushbutton 14, you will use the UFC to enter the target coordinate and elevation for the selected PP mission.

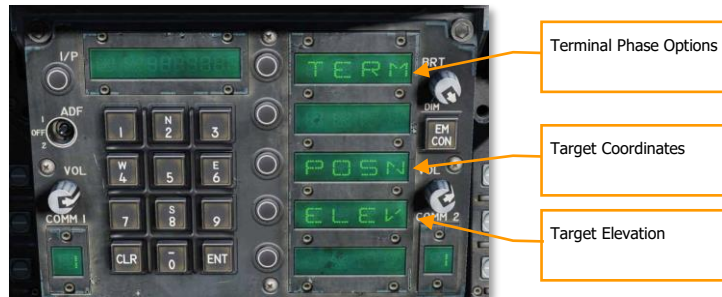

**POSN** is the lat / long coordinate of the target. This is entered as longitude and longitude in degrees, minutes, and seconds.

**ELEV** can be entered in FEET or MTRS (meters). Valid range for FEET is -328 to 32808 and MTRS is -100 to 10000. We will skip MSL or WGS selection as pictured below.

Once a valid elevation and target coordinate have been entered and saved, the selected PP mission will no longer have an "X" through it and the TGT (target) information on the MSN screen will be complete.

**Terminal Phase Options** are entered as the weapon impact angle, weapon impact heading, and weapon impact velocity. Selecting TERM displays three options on the UFC for:



- HDG. Heading of weapon at time of impact. Valid range if from 0° to 359°.
- ANG. This is the impact angle of the weapon. Valid range is 0° to 90°.
- VEL. Velocity at impact. Valid range is 100 to 26800 feet per second.

### *Target of Opportunity Mission Programing Sub-Level*

When the mission option is set to TOO, the mission planning screen regarding the target being the designated location (designated waypoint or target point). The page options are like that of the PP mission planning screen, but with the following changes:

- No programable pre-planned missions
- No target UFC option; only terminal phase as described above

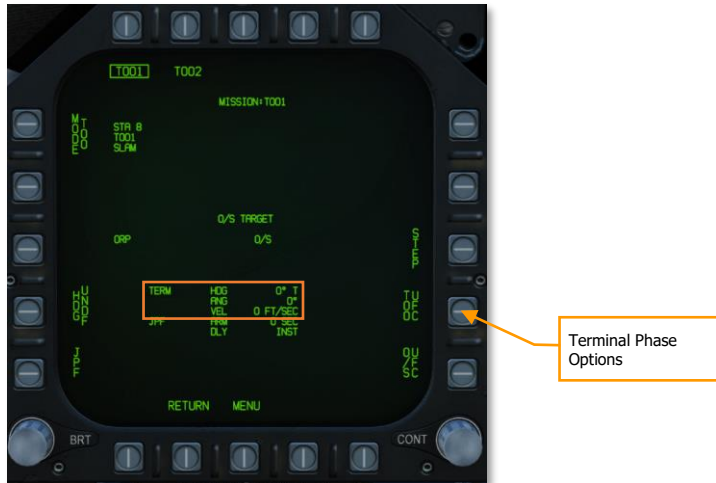

## SLAM and Datalink Pod Combined Employment

When the AN/AWW-13 datalink pod is paired with the SLAM in combined form, it provides use of the infrared imager. This entails minor changes to the format pages but adds video display.

Upon selection of the AGM-84E SLAM from the top row of the SMS page, the SLAM format without AN/AWW-13 datalink pod page is displayed. Each SLAM needs to be individually paired with the datalink pod:

1. From the SLAM format page, both SLAM and DL13 (datalink) pod must be selected and boxed from pushbuttons 6 to 10.
2. With SLAM and the DL13 selected, pressing WEP at pushbutton 15 boxes the option and displays up to four SLAMs next to pushbuttons 2 to 5.
3. Selected the displayed SLAM within pushbuttons 2 to 5 pairs that SLAM to the DL13, and SLAM is displayed below DL13 at pushbutton 8. Once paired, WEP becomes unboxed.

New elements of the combined SLAM DL13 format page include:



**Weapon Assignment.** Pressing pushbutton 15 selects (boxes) the option and will display available SLAMs available for pairing to the datalink pod.

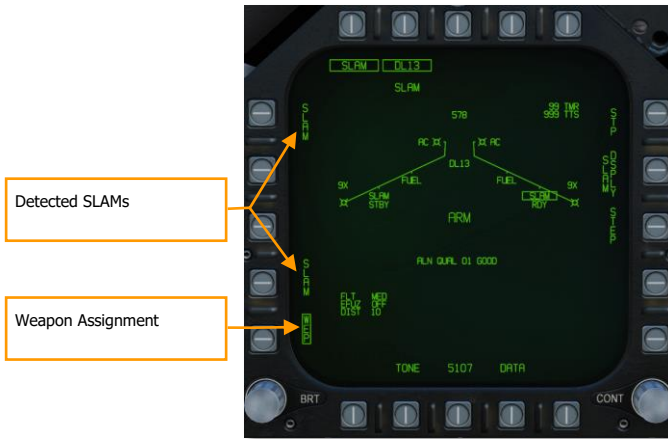

**Time to Seeker (TTS).** Once a SLAM has been paired to the datalink pod, a valid PP or TOO target has been set, and a seeker activation distance has been entered, a TTS field is displayed that counts down in seconds the time to the time the seeker will activate. This can range between 001 and 999.



**Seeker Distance.** Once the missile and the datalink pod have been paired, the seeker activation distance is displayed in the bottom left corner of the display. The default value is 10 nm.

### *Weapon Quantity and Mission Option Sub-Level*

This sub-level page functions the same as the SLAM without datalink pod except it adds a Seeker Activation UFC option that determines the range from target that the terminal seeker will activate.



**Mission Options.** This page allows the player to create Target Data Sets (TDS) for the selected SLAM against the selected target. The Mission Data (MSN) format is accessed by pressing the MSN option at pushbutton 4. The Mission Data format is used to select and program one of the 6 available PP missions or a TOO target. A mission is selected by depressing one of the PP# options at [PB6]-[PB11] if PP mode is selected. If in TOO mode, the target is based on designated target location. One of the various UFC options along the lower right side of the format is then selected to begin program data entry. Note that program data may be pre-programmed in the Mission Editor.

**Release Type.** This cue lists the selected release mode for the selected weapon: AUTO or MAN.

**Seeker Activation Distance UFC.** This enables entry of the distance from target at which the seeker display activates.



## SLAM Terminal Seeker

Once the Time to Seeker time reaches zero and the DDI is set to the SLAM format page, the page will be replaced by the video image from the SLAM terminal seeker. This is a modified version of the infrared seeker as used for the AGM-65F. Upon the seeker video being displayed, the pilot may uncage the seeker and lock it to a contrasting target. Upon seeker lock, the SLAM will steer to intercept the target.

Seeker video is displayed over the entire SLAM display, with stroke written symbology displayed over the weapon video. The video display format includes the following:



**Weapon Video.** Composite Video will be routed to displays with the video format selected. In addition to the IR scene, missile video shall include symbology for seeker position, a good lock indication, tracking polarity indication, FOV indication, and seeker depression indication. If the missile loses track or does not manage to lock-on to a target, a break-lock condition will occur. The missile will then go into correlation track (video crosshairs will retract to the edge of the display) and will remain there until either a cage/uncage or a TDC action slew. Note also when the missile is in track mode, an exclusion window is placed around the target, within which the large crosshairs and the pointing cross will not be displayed. If the pointing cross should fall within this tracking window, then the portions of the cross that fall within the region will be blanked.

**Pointing Cross.** The seeker position will be indicated by a small pointing cross. The pointing cross position relative to the large crosshairs will indicate the seeker position. Relative to missile boresight the tick marks along the vertical crosshair are spaced by  $5^\circ$ , thereby indicating the depression angle and the scale. When the seeker is in track and either the target is not within the launch constraint window or the tracking performance is poor, the small pointing cross will flash. A steady pointing cross will indicate a good lock.

**TDC Assignment.** This diamond-shaped symbol appears in the upper right corner of the display whenever the TDC is assigned to the SLAM.

**Field of View.** The IR video will initialize to wide FOV. While the seeker is not in Track mode, the FOV (FOV) options can be toggled via two methods. The FOV can be changed by selecting FOV option on the Maverick format, or by the throttle outboard switch (HARM Sequence/FLIR FOV/RAID).

**Field-of-View Brackets.** The video display will place four corner brackets within the wide FOV indicating what area will be encompassed in narrow FOV. The corner brackets are not displayed in narrow FOV.

**Caged/Uncaged Status.** The caged/uncaged status of the weapon is continuously provided on the video format. when the weapon is initially selected with no existing designation, CAGED is displayed. when an uncage signal is commanded to the missile (by depression of the uncage switch, selection of the Forced Correlate option, action slewing of the TDC, or by making a designation), UNCAGED is provided on the format.

## SLAM HSI Format



**SLAM Target.** This is a solid triangle symbol at the location of the PP target location, or a solid diamond if a TOO target location. The symbol shows the last selected PP or TOO mission.

**Minimum Range.** This is a circle that is centered on the target and indicates the minimum acceptable launch radius of the selected SLAM. This cue is not displayed when the aircraft is within the IZLAR.

**In Range LAR (IRLAR).** This larger circle is also centered on the target and represents the range at which the selected SLAM can be launched under current flight conditions (heading, altitude, and airspeed) and provide a minimum impact angle of 35° and a minimum impact velocity of 300 feet per second. This cue is removed when the aircraft is within the IRLAR.

**Predictive Max Range.** This dashed line indicates the absolute maximum launch range to the target, not accounting for impact angle and speed. This will always be greater than the IRLAR. The line will run from the target and through the ownship. At the end of the dashed line is a bar. This bar should always be at the best-case maximum range for a SLAM.



## SLAM HUD

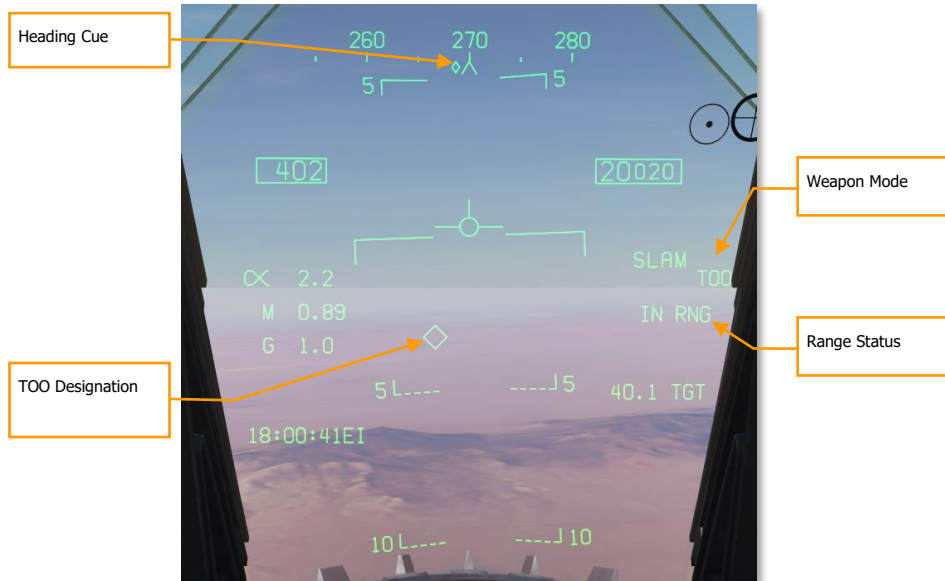

**Heading Cue.** This cue on the heading tape provides steering direction to the IZLAR. If a release quantity of more than 1 is selected, this cue is not displayed and the waypoint or TACAN cue is displayed instead.

**TOO Designation.** Diamond system that indicates the line-of-sight location to the TOO TGT. When in PP mode, the diamond symbol is also displayed.

**Weapon Mode.** Displays the name of the selected weapon type (SLAM) and either TOO or PP based on mode selection.

**Range Status.** The Time to Maximum Range (TMR) is visible when the aircraft is within 10 minutes of reaching the IZLAR. It will then start at 9:59 and count down as range closes. Once the aircraft is within the IRLAR, the cue changes from TMR to IN RNG. The IN RNG will flash if the aircraft is within 5 seconds of flying outside the INLAR or inside the minimum range zone. If the aircraft is inside the IZLAR zone, then the cue changes to IN ZONE.

# AGM-84H SLAM-ER (EXPANDED RESPONSE)

The AGM-84H SLAM-ER is a further development of the SLAM that extends the range to 150 nautical miles and improves the missile's terminal guidance. Employment of the SLAM-ER is nearly identical to that of the SLAM; see the previous section for information on how to use the SLAM-ER.

The SLAM-ER will appear as "SLMR" on the Stores format. It works with the same AWW-13 Datalink Pod as the SLAM.

## Creating a SLAM-ER Turn Points (STPs)

The SLAM-ER can follow a sequence of up to five STPs to the target. You can use this sequence to specify the route that the SLAM-ER should follow to the target.

To specify an STP sequence, box PB11 (labeled "STP") on the Stores format. The STP label appears when you have boxed SLAM-ER (SLMR).



Figure 222. SLAM-ER STP List

Select the pushbutton next to "STP1" on the UFC to set STP 1.



Figure 223. SLAM-ER STP Creation

**VEL.** Specifies the velocity the missile should achieve upon reaching the STP, in knots.

**WYPT.** Sets the STP location to a waypoint. Enter the waypoint number and press ENT.

**POSN.** Sets the STP location to a latitude/longitude or an MGRS grid.

**ALT.** Sets the altitude the missile should achieve upon reaching the STP, in feet.

**DEL.** Deletes this STP. Any successive STPs will be shifted up.

After creating STP1, "STP2" will appear on the UFC list, allowing you to add a second STP if you wish.

## AWW-13 Datalink Format

SLAM-ER datalink video can be set to activate a certain distance from the target in the same manner as the SLAM. To pair the SLAM-ER with the AWW-13 Datalink Pod, select both the SLMR and DL13 options from the Stores format. Press the pushbutton labeled "WPN" and select a SLAM-ER from the list to pair the Datalink Pod to it. You will then see the combined SLAM-ER + AWW-13 video format:

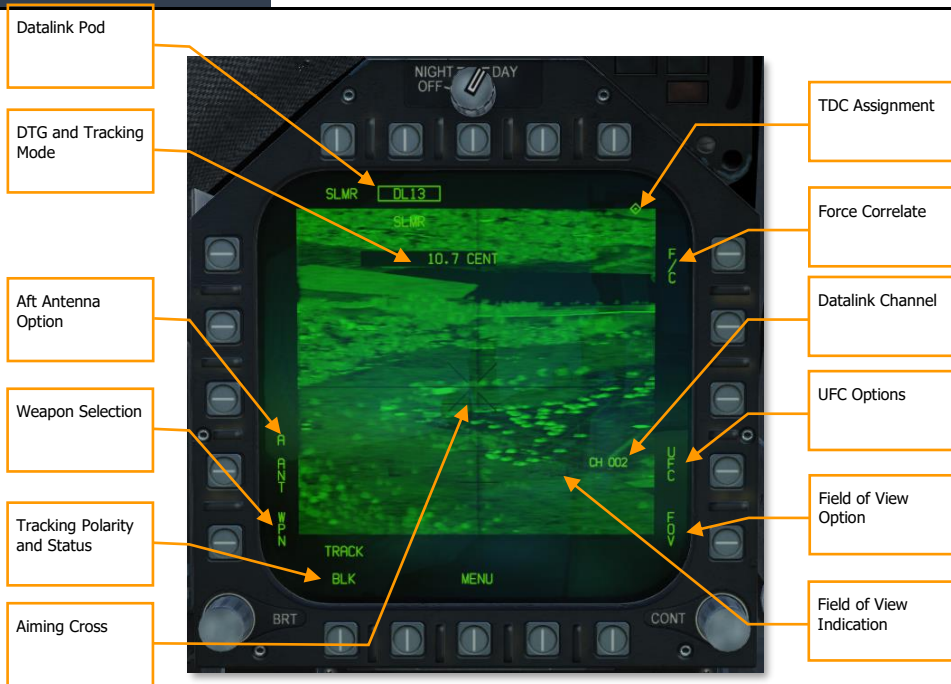

Figure 224. SLAM-ER Datalink Video

**Datalink Pod.** Boxed when the AWW-13 is selected as the active Stores sub-page.

**DTG and Tracking Mode.** Displays the distance to the target in nautical miles and the seeker tracking mode: "CENT" for centroid tracking and "F/C" for forced correlation. Distance to go is not displayed if the SLAM-ER was not launched with a target waypoint.

**Aft Antenna.** When boxed, the AWW-13 will use its aft antenna instead of its forward antenna. If you lose signal as you turn away from the missile, use the aft antenna.

**Weapon Selection.** Pressing this PB will allow you to select which weapon to link the AWW-13 to (if you have multiple SLAM-ERs loaded).

**Tracking Polarity and Status.** Cycles through centroid tracking polarity options. Displays "BLK" when tracking dark objects and "WHT" when tracking bright objects. "TRACK" is displayed when the SLAM-ER is tracking an object.

**Aiming Cross.** This cross represents the aimpoint of the missile. To slew the aiming cross, hold down the TDC. The image will freeze. While holding down the TDC, use the TDC to reposition the aiming cross to a new location, and release the TDC. The missile will attempt a new track and steer to the new aimpoint.

**TDC Assignment.** Shown when TDC is assigned to this display. TDC must be assigned to the SLAM-ER/AWW-13 video display to move the aiming cross.

**Force Correlate.** Cycles between centroid tracking and forced correlation. Centroid tracking attempts to track bright or dark shapes in the image and is more effective against moving vehicles. Forced correlation attempts to track part of an image and is more effective when pinpointing part of a larger structure.

**Datalink Channel.** Displays the radio channel that the AWW-13 is tuned to. Each missile is assigned a datalink channel based on its station number (e.g., the SLAM-ER loaded at station 2 will transmit over datalink channel 002). Pressing the adjacent PB (PB 14) allows you to specify which channel to tune the AWW-13 to using the UFC.

**UFC Options.** Pressing this PB displays options on the UFC (see below).

**Field of View Option.** Pressing this PB cycles between wide and narrow field of view.

**Field of View Indication.** The square brackets indicate the extent of the narrow field of view. The horizontal lines indicate depression from boresight and are spaced 5° apart.

# AGM-62 WALLEYE II ER/DL WITH AN/AWW-13 DATALINK POD

The AGM-62 Walleye II ER/DL (Guided Weapon Mk. 5, nicknamed "Fat Albert") is an air-to-surface, homing glide bomb that incorporates television guidance. It has a 2,000-pound warhead with a maximum glide range of approximately 40 miles. Using HOTAS controls, the pilot can slew the seeker to have it lock on to a target with enough visual contrast. The seeker will then self-track the target even after weapon release. Using the AN/AWW-13 datalink pod, video from the television seeker can then be displayed on the Walleye format page. Using the datalink, the pilot may redirect the bomb to a different target while in flight. The ER/DL in the name indicates Extended Range / Datalink.

The Walleye is designed to attack large, static targets like buildings and bridges, and it can only be mounted on stations 2 and 8 as singles on BRU-32/A bomb racks.

The AN/AWW-13 Advanced Datalink Pod is used to communicate with the Walleye II ER/DL. It allows for retargeting of the weapon after it has been launched by transmitting and receiving post-launch slew and lock-on commands. The AN/AWW-13 provides man-in-the-loop guidance.

The AN/AWW-13 datalink pod can be held on stations 2, 3, 5, 7, and 8.



Figure 225. Walleye II ER/DL



Figure 226. AN/AWW--13

## Walleye SMS Page

Because of the possible combination of loading Walleyes and the AN/AWW-13 datalink pod, there are three possible format pages. These formats replace the standard wingform format when selected.

- Only datalink pod
- Only Walleye
- Both datalink pod and Walleye

When both Walleye and the datalink pod are selected, only the top 80% of the displays has video with stroke symbology over the entire display.

### AN/AWW-13 Datalink Pod Only Selected



Figure 227. Datalink Only Format

When the datalink pod is selected and a Walleye is not, the top 80% of the display is static because the datalink pod has not been linked to a Walleye seeker. Elements of the datalink only page include:

1. **Datalink Pod Selection Option.** If a datalink pod is loaded, this option allows selection of the pod. This is indicated as DL13 for the AN/AWW-13 pod.
2. **Weapon Selection Status.** An indication of weapon selection status is provided which is like that provided in the Stores format. When an A/G release ready condition exists, RDY is displayed beneath the weapon selection box.
3. **Pod Antenna Option.** The A ANT option selects the aft antenna of the datalink pod. It is boxed when selected. The selection allows forward and aft antenna control of the datalink pod. This can be useful when self-guiding (aft antenna) or potentially guiding for another aircraft (forward antenna).
4. **Weapon Selection.** The Weapon option links the datalink pod to the selected datalink capable weapon. When linked, the option is boxed.
5. **TDC Assignment Indication.** This diamond indicates that the TDC is assigned to the display. To slew the seeker, the TDC must be assigned to the weapon video page.
6. **UFC Pod Channel Selection Option.** This option is used to select one of the two pre-set pod datalink channels, channel 2 if the Walleye is on station 2, or channel 8 if the Walleye is on station 8. Pressing PB 14 displays CHNL on the top Open Select Window on the UFC. Upon colonizing the window, the channel is entered using the keypad and ENT is pressed. If a valid channel is entered (2 or 8), the channel number is listed after CH on the datalink format (002 or 008).

## Walleye Only Selected

When a Walleye has been selected but the datalink pod has not, the format page provides functionality to conduct a Walleye attack without datalink. In such a situation, the Walleye can be locked to the target before launch, and there would be no seeker video update once launched. In many ways, it behaves like an infrared-guided Maverick.

Elements of the format include:

1. **Weapon Selection Status.** An indication of weapon selection status is provided which is like that provided in the Stores format. When an A/G release ready condition exists, RDY is displayed beneath the weapon selection box. Otherwise, an "X" is displayed through the WEDL acronym.
2. **Station Select Indication.** The Walleye can be carried on stations 2 and 8. The weapon station selected is indicated beneath the weapon selection status. Station 8 is the default priority station. This can be useful when setting up the correct datalink channel.
3. **Selected Station.** Walleye 2 ER/DL is displayed as WEDL.
4. **Electrical Fuzing Options.** The Walleye has two mutually exclusive fuzing options, instantaneous (INST) and delay (DLY). Pushbutton 5 is used to select instantaneous mode and pushbutton 4 is used to select delay mode.
5. **Caging Retention and Boresight (CRAB).** When the Walleye seeker has been slewed off boresight, this option is displayed. Pressing and holding the pushbutton returns the seeker to boresight.
6. **Station Step (STEP) Option.** Pressing the STEP option toggles the selected Walleye station. If less than two Walleye are loaded, this option is removed from the format.



7. **Video Crosshairs.** The Walleye crosshairs are a part of the weapon video and are colored white.
8. **Missile Axis Position (MAP) Indicator.** The MAP indicator is displayed in the weapon video. Its boresight axis is relative to the guidance head position, and therefore provides an indication of the angle of attack when the weapon is in flight. The MAP indicator is not displayed when it is inside the tracking gate (intersection of the crosshairs). The MAP indicator is displayed at one-half size vertically while the guidance head position is being slewed using the datalink (after the weapon has launched).
9. **Cage/Uncage Status.** The caged/uncaged status of the weapon is provided on the format. When the weapon is initially selected, CAGED is displayed. When the cage/uncage button is pressed to allow the seeker to be slewed, UNCAGED is displayed.
10. **TDC Assignment Indication.** This diamond in the top right concern of the format indicates that the TDC is assigned to the display.

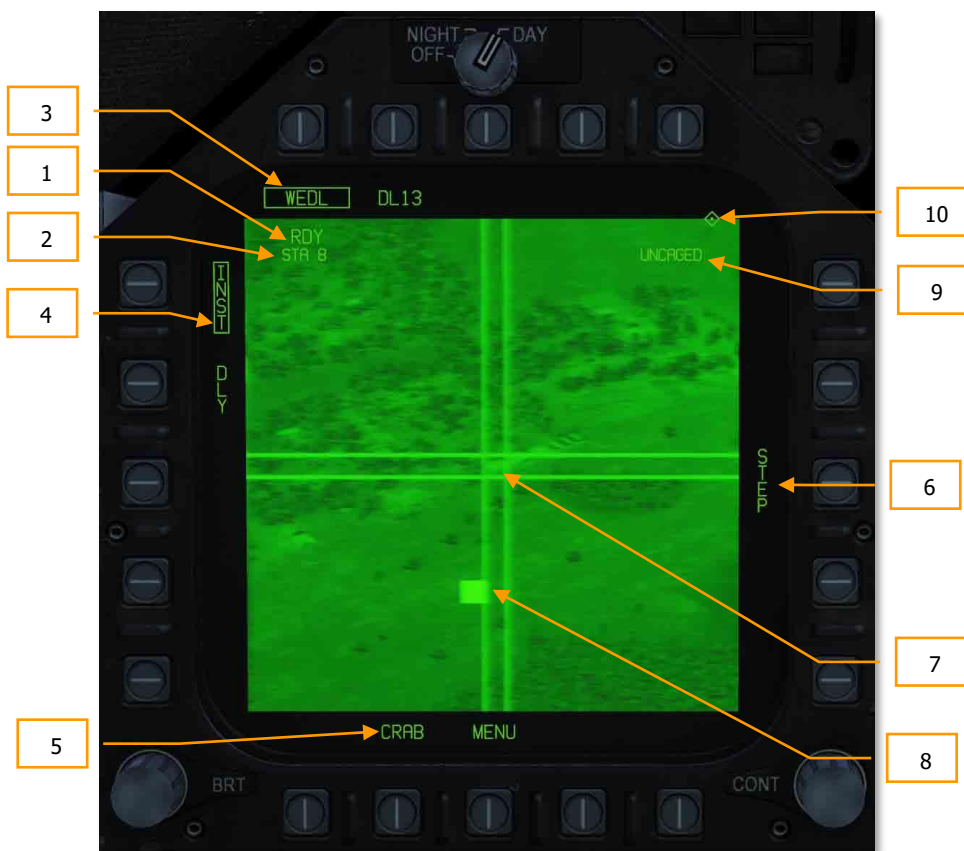

Figure 228. Walleye Only Format

## Weapons Practice: AGM-62 Walleye

*How to Employ the AGM-62 Without Data Link*

1. Master Arm to ARM and Master Mode switch to A/G
2. Select WEDL twice from the SMS page
3. Set TDC to the Walleye format page
4. Uncage the seeker by pressing Cage/Uncage button or **[C]**.
5. Slew the crosshair center over a larger target and wait for the seeker to lock on. Indicated by the RDY indication and WE crossed out on the HUD.
6. Press the weapons release button **[LAlt] + [Space Bar]** to release the weapon.

## Walleye and Datalink Pod Both Selected

The Walleye is most effective when paired with the datalink pod. To pair the two systems:

1. Select (box) both the Walleye and datalink pod. This will show the combined Walleye / datalink pod format.
2. From pushbutton 1, select WPN (weapon). This informs the datalink pod that it is to be paired with a datalink-capable weapon. Available datalink weapons will now be listed as options for pushbuttons 1 to 4. Walleye (WEDL) will appear on pushbutton 5.
3. From pushbutton 5, select WEDL to pair the Walleye and datalink pod. If successful, WEDL will appear below DL13 at pushbutton 8.

Note: if you are not then receiving seeker video, you probably need to set the datalink to the other channel (either channel 2 or 8).



Figure 229. Combined Walleye and Datalink Format

## Walleye HUD



The Walleye HUD consists of the following elements:

1. **Walleye Reticle.** This reticle that duplicates the AG rocket and gun reticle, is positioned 3° below the waterline by default. As the Walleye seeker is slewed, this reticle will reflect seeker slew. In the center of the reticle is an aiming pipper.
2. **Weapon Name.** Walleye II is displayed as WE.

# DEFENSIVE SYSTEMS



# INTEGRATED COUNTERMEASURES CONTROL PANEL (ICMCP)

## Mission Practice: F/A-18C Defensive Systems

As this is Digital COMBAT Simulator, you will often find yourself as the target of enemy weapon systems. The F/A-18C includes several defensive systems to assist you in your fight to keep alive that includes expendable countermeasures of chaff and flares and Electronic Countermeasures (ECM).

The lower console instrument group is dominated by the countermeasures dispensing system. This system provides protection against tracking radar, air-to-air and surface-to-air missiles. Protection is provided by ejecting chaff, flare, or jammer payloads (GEN-X).

The ALQ-165 Airborne Self Protection Jammer (ASPJ) is the onboard Electronic Countermeasure (ECM) system. The ALQ-165 detects and deceives threat pulse fire control and guidance radars and has four operating modes: standby, receive, transmit, and built-in test. This ECM system detects, processes, and transmits a simulated target echo for deception when a radar signal is received. The simulated echoes are recognized by the enemy radar as true target returns. Tracking radar then tracks a false target and breaks lock from the true target. Threat radar indications are indicated as both lights and the Radar Warning Receiver.

The ICMCP replaces the old ALR-39 panel and moves many of the control functions to the DDI EW page.

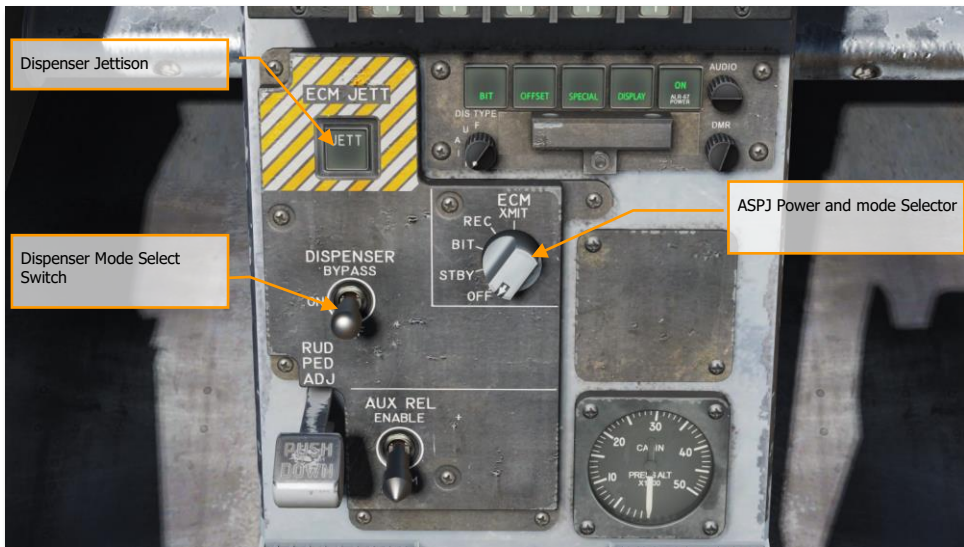

Figure 230. Integrated Countermeasures Control Panel

Elements of the ICMCP include:

**Dispenser Jettison Button.** Pressing this button releases all chaff and flares onboard. This switch only works with no weight on wheels and the button will illuminate when pressed.

**Dispenser Mode Select Switch.** This switch has three positions:

- **OFF:** Turns the CMDS power off and ALE-47 legend on the EW page has an X through it. However, the ECM JETT button will still function.
- **BYPASS.** This selection bypasses the EW system entirely. When the throttle dispense switch is pressed forward, two chaff are released; when pressed aft, two flares are released, regardless of the selected program. When mode is set to BYPASS, the ALE-47 indication on the DDI EW page will have an "X" through it, and the EW page BIT element will indicate NOT RDY.
- **ON:** When set to ON, there is a five second warm up period and a BIT is conducted. After five seconds, it is ready for operation. When in ON mode, the release modes of STBY, MAN, SEMI, and AUTO can be selected.

When first set to ON, SF TEST will appear for five seconds below the EW legends on the DDI EW page. After which, PBIT GO will be displayed for ten seconds. Once that is complete, OFF or the selected mode will be displayed.

# EW PAGE



Figure 231. EW Page

At the bottom of the countermeasure panel is the control indicator. This panel has the following functions:

**ASPJ Power and Mode Indicator.** Based on the setting of the ALQ-165 ASPJ Power and Mode Selector, the ASPJ legend will be OFF below it when the ASPJ is set to OFF. When set to one of the other four modes, the mode is displayed below the ASPJ legend: XMIT, REC, STBY, or BIT. (N/I)

**Chaff Indicator.** This field indicates the number of chaff bundles remaining. A box is placed over the number when a chaff bundle is released.

**Flare Indicator.** This field indicates the number of flares remaining. A box is placed over the number when a flare is released.

**ALE-47 Power and Program Indicator.** When the dispenser switch is set to ON, the selected release program type is displayed below the ALE-47 legend. There are 6 manual (MAN) programs that can be stored and edited. Semi-Automatic (S/A) and Automatic modes (AUTO) are also available that will select a program to match the threat and allow the pilot to initiate a program (S/A) or have the CMDS initiate a program automatically (AUTO). To select manual (MAN) programs, successive presses of the STEP OSB will cycle through the programs and the name of the selected program will be displayed below the ALE-47 legend (i.e. MAN 5). If semi-automatic mode is selected, S/A will be displayed and if automatic mode is selected AUTO will be displayed.

If the ALE-47 is powered off from the ICMCP panel, then OFF will be displayed below the ALE-47 legend.

When first set to ON, SF TEST will appear for five seconds below the EW legends on the DDI BIT page. After which, PBIT GO will be displayed (EW BIT complete). Once the BIT is completed, the OFF legend is removed.

Pressing the ALE-47 OSB should box the ALE-47 legend and the C, F, O1, and O2 indications should appear on the along the top of the EW DDI page with the following values: C 14, F 18, O1 14, and O2 14.



When the dispensers are set to Bypass, the legend will have a dash through it.

**EW Power.** Indicates power status of the ALR-67(V) system based on the Control Indicator Panel power button. When un-powered, the EW legend has OFF below it. Also, when disabled, the EW mode, offset, limit, and HUD status indications on the EW page are removed.

**HUD EW.** Displays EW contact symbols to the HUD when boxed.

**EW MODE.** Successive presses of the mode OSB will cycle through the EW mode options:

- **STBY.** The CMDS has power but cannot dispense countermeasures except for EW JETT.
- **MAN.** Up to six manual programs can be selected and programmed using the PROG sub-level. Only on MAN mode are the STEP and PROG OSB options visible.
- **S/A.** The CMDS will choose from a library to select the best program against the primary threat. The pilot though must consent to initiate the program. (Coming later in Open Beta)
- **AUTO.** The CMDS will choose from a library to select the best program against the primary threat. The CMDS will automatically initiate the program. (Coming later in Open Beta)



**ARM.** When the ALE-47 OSB is pressed and boxed, the ARM legend is displayed. When the ARM OSB is pressed, the SAVE OSB will appear next to the STEP OSB. Additionally, new manual programming options will appear. To create a manual program, pressing the ARM OSB displays the CMDS PROG sub-level. Successive presses of the STEP OSB will cycle through the five, manual programs. The selected program can be seen in the center of the page (CMDS PROG x). Along the left side of the page, OSBs to select chaff (CHAF), flares (FLAR), GEN-X decoys (OTH1 and OTH2), release repeat (RRT), and release internal (INT) parameters are displayed. Pressing one of these OSBs will box the legend and thereby select it for programming. Using the up and down arrows on the right side of the page, you may adjust the value of the selected program element. The value for each program element is displayed in the center of the page. Once complete, pressing the SAVE OSB will have the parameters to the selected program and pressing the RTN (return) OSB will return to the main EW page.

Figure 232. EW Programs

**ALE-47 Program STEP.** Manual programs can be cycles through (1-6) with successive presses of the STEP OSB. The selected program number is indicated below the ALE-47 legend at the top of the page. The primary means for dispensing chaff and flares is with the countermeasures dispense switch on the throttle.

- **Flare / Rear.** Releases one flare from each of the left and right dispensers that contain a flare in a group of 10.
- **Chaff / Forward.** Released one chaff burst.

## EW Symbols

The EW page displays different symbols for air and ground radars, as well as hostile and friendly radars:



**Airborne radar, Friendly.** Radar signal detected from a friendly air-to-air radar.



**Airborne radar, Unknown.** Radar signal detected from an air-to-air radar of unknown affiliation.



**Airborne radar, Friendly.** Radar signal detected from a hostile air-to-air radar.



**Air defense radar, SAM.** Radar signal detected from an air defense radar associated with a surface-to-air missile (SAM) system.



**Air defense radar, AAA.** Radar signal detected from an air defense radar associated with an anti-aircraft artillery (AAA) system.



**Air defense radar, Naval.** Radar signal detected from a naval vessel, usually associated with an air defense (SAM/AAA) system.



**Surveillance/Early Warning Radar.** Radar signal detected from a surveillance or early warning radar system.

## EW BIT

When conducting an EW BIT, both graphical and audio tests will be run.

On both the EW page and azimuth indicator, the following test images will be displayed with three seconds between each.

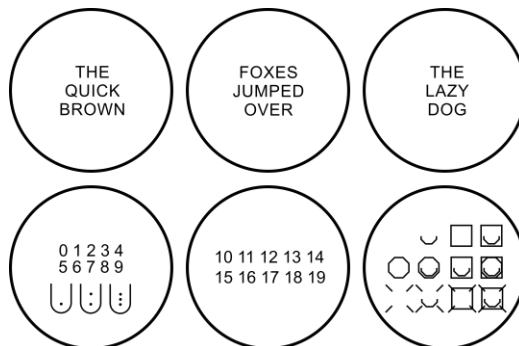

*Figure 233. EW BIT Images*

In parallel, each of the ALR-67 tones would be played. These include:

- New Contact (waterfall)
- AAA
- Missile Launch
- Radar Lock
- Power Up

# ALR-67(V) AZIMUTH INDICATOR

Detected radars by the ALR-67(V) are displayed on the Azimuth Indicator (aka Radar Warning Receiver) and on the HUD when enabled.

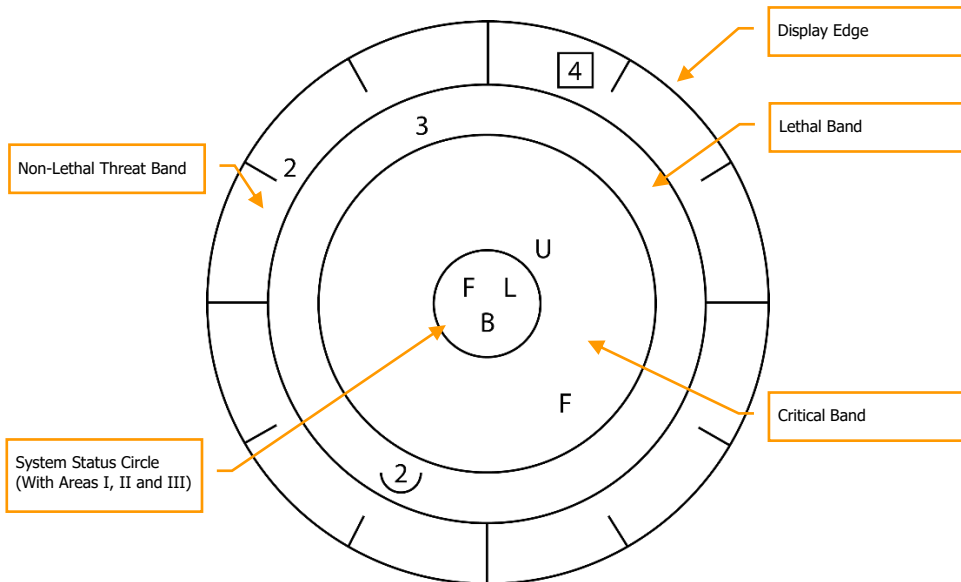

Figure 234. Azimuth Indicator

When a radar emitter is detected, the ALR-67(V) Azimuth Indicator visually indicates the radar signal source with a coded symbol. The coded symbol indicates the type of emitter detected, and its position on the azimuth indicator indicates the relative bearing to the emitter. The ALR-67(V) system detects multiple emitters and provides relative bearing to each emitter. Audio tones are produced as an advisory for emitter, or BIT status change. This will mirror the DDI EW page.

The emitter and status display is shown on the azimuth indicator when power is applied to the ALR-67(V) system. When an emitter is detected and analyzed by the ALR-67 system, an alphanumeric symbol representing the emitter is displayed. Certain types of emitters, when detected, are assigned unique alphanumeric symbols for display.

The azimuth position of the displayed emitter symbol represents the relative bearing of the emitter with respect to the nose of the aircraft. As an example, the image above shows a naval threat enhancement (boat symbol) at 40°.

The display area of the azimuth indicator is divided into four unique areas listed below:

- Critical band
- Lethal band
- Nonlethal band

- Status circle

The critical band is the outermost band in which specific threats or modes of lethal threats are displayed. Azimuthic marks are engraved in the outer most portion of the critical band. The tic marks are in 30° increments. The lethal band is the second band in from the outer most portion of the display. Emitters displayed in the lethal band are threats that have been determined to be lethal. The nonlethal band is the innermost band of the display. Emitter symbols in the nonlethal band represent unknown and friendly emitters. Known emitters that have been determined to be nonlethal are also displayed in the nonlethal band.

The status circle is in the center of the azimuth indicator and displays ALR-67(V) system status. The status circle is divided into three areas of display:

- Upper left quadrant of circle (area I)
- Upper right quadrant of circle (area II)
- Bottom half of circle (area III)

Area I displays the priority setting of the EW Mode as set on the EW page (**N, I, A, U, or F**).

Area II is either blank when ALR-67(V) system is operating in the full display mode or displays the character **L** when operating in the display limit mode.

Area III displays current ALR-67(V) Built-In Test (BIT) status. Area III is blank when there are no ALR-67(V) system failures. The character **B** is displayed when a failure is detected. The character **T** is displayed when a thermal overload has been detected in Countermeasures Computer or Radar Receiver.

Any time a new emitter symbol is displayed on the azimuth indicator, or an emitter symbol goes from a less lethal to a more lethal band, a status change tone is generated by the ALR-67(V) system. Special tones are also generated for specific threats or critical threat modes of operation. Threats no longer transmitting or going from a more lethal to a less lethal band do not cause a status change tone.

## ALR-67(V) Control Indicator Panel

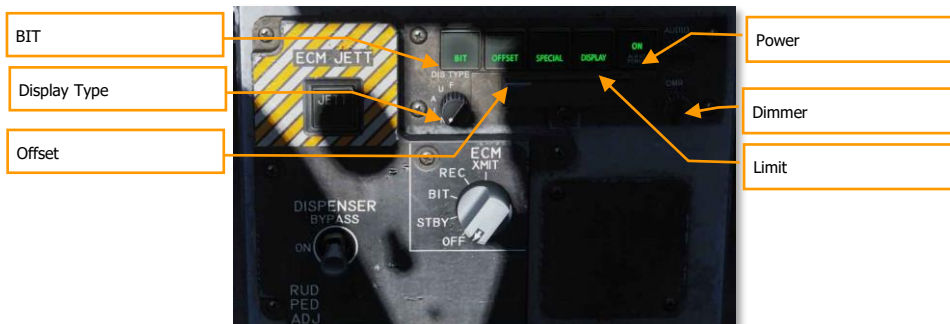

*Figure 235. Control Indicator Panel*

At the bottom of the countermeasure panel is the control indicator. This panel duplicates the functions on the DDI EW page. This panel has the following functions:

**POWER.** Turns the ALR-67(V) system on and off. When pressed to the on position, the POWER, DISPLAY, SPECIAL, OFFSET AND BIT light will illuminate.

**LIMIT.** When pressed, LIMIT light on DISPLAY pushbutton switch comes on and emitter display is limited to the six highest priority emitters. An "L" will be displayed in status circle area II on azimuth indicator. Pressing again deselects the option.

**OFFSET.** When pressed, ENABLE light on OFFSET pushbutton switch comes on, and overlapping symbols on azimuth indicator are separated to ease reading of display. Pressing again deselects the option. (Coming later in Open Beta)

**BIT.** When pressed, enables current BIT status to be displayed on the azimuth indicator. FAIL light on BIT pushbutton switch will come on whenever periodic BIT detects a failure. Pressing again deselects the option.

**Dimmer.** Controls brightness of the lamps on the control-indicator. Clockwise rotation increases brightness, counterclockwise rotation decreases brightness.

## Right Instrument Panel Warning / Advisory / Threat Display Panel



Figure 236. Right Instrument Panel Warning / Advisory / Threat Display Panel

Working as part of the ALR-67, green warning lights at the top of the right instrument panel alert the pilot of the type of radar energy painting the aircraft:

- **AI:** Hostile air intercept radar in lock mode (lethal band)
- **CW:** Hostile radar in continuous wave mode and probably guiding a missile (critical band)
- **SAM:** Surface-to-Air Missile radar that has locked on (critical band)
- **AAA:** Radar directed anti-aircraft artillery.
- **DISP.** The ALE-47 has a program ready for the detected threat and is waiting for start consent. In addition, a DISPENSE cue will be displayed on the HUD. (Coming later in Open Beta)
- **GO and NO.** BIT result from when the Dispense switch is set to ON or BYPASS. BIT will take five seconds.

# AIRBORNE SELF-PROTECTION JAMMER (ASPJ)

The Lot 20 F/A-18C is equipped with the AN/ALQ-165 Airborne Self-Protection Jammer, or ASPJ. The ASPJ is an integrated electronic countermeasures system that can detect and analyzing inbound radar locks and selecting appropriate electronic countermeasures (jamming programs) to counter the lock.

The ASPJ is a "gate-stealing" jammer. In contrast to a noise jammer, which attempts to deny the enemy a target lock by overloading his radar receiver with radio noise, a gate-stealing jammer lures the radar into tracking a "cover pulse," a false echo generated by the jammer that is much more intense than the actual echo. Once the enemy radar is tracking the cover pulse, the jammer can modulate the signal to walk the range or velocity gate off the actual aircraft, then break the radar lock by ceasing its transmissions.

The ASPJ is itself capable of detecting inbound radar locks and can also use data from the AN/ALR-67 radar warning receiver to determine when to run jamming programs.

The ASPJ mode is controlled with the ECM knob on the lower center console.

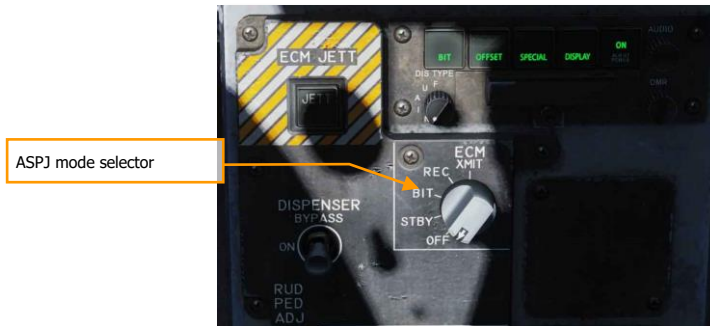

The mode is indicated on the EW page adjacent PB8:



**OFF.** The ASPJ is powered down. The “ASPJ” moniker will be crossed out on the EW page.

**STBY.** The ASPJ powers on and completes its warmup and built-in tests (BIT). It will not transmit or receive. The warm-up period takes approximately five minutes to complete. When the BIT is complete, the STBY light on the left alert panel will illuminate.

**BIT:** Not implemented.

**REC:** The ASPJ is powered on and will detect and alert for inbound radar locks.

**XMIT:** The ASPJ has consent to jam. It will automatically initiate jamming when a radar lock is detected.



When the ASPJ detects a radar lock, the REC light will illuminate on the left alert panel. If the ASPJ is in XMIT mode, the XMIT light will also illuminate during jamming. A “JAMMER ON” indication will display on the attack radar format during transmission.



## Employing the ASPJ

The ASPJ should be powered on in STBY mode prior to entering the combat area. The warmup period takes up to four minutes, during which BITs are run. If all BITs pass, the GO and STBY lights will illuminate. The ASPJ should be placed into REC mode when enemy radar activity is expected.

The jammer should be placed in XMIT mode as needed during engagements. Jamming creates a great deal of radar energy, which makes it easier for enemy radars to determine the azimuth of your aircraft, while denying them range information or a radar lock. The jammer could potentially alert enemy aircraft of your azimuth before they would normally detect you, so it should be left off until the enemy is already aware of your presence. The jammer can then be used deny radar lock.

At closer ranges, the jammer will be unable to generate cover pulses of sufficient intensity to mask actual radar returns. This is called "burn-through," and closer than this point, the jammer will be less effective at breaking lock. In addition, some missiles, such as the AIM-7 Sparrow and AIM-120 AMRAAM, have a home-on-jam (HOJ) mode, where the missile switches to passive radar guidance and homes in on the radar energy from your jammer. For these reasons, the jammer should be switched off during medium- to close-range engagements.



# HOTAS CONTROLS

On the throttle, there is a three-place switch for countermeasures.

- **Center.** This is the OFF position and no dispense action is taken.
- **Aft.** When in BYPASS mode, this will release one flare. If not in BYPASS mode or OFF, AUTO, S/A, or MAN mode will initiate the program.
- **Forward.** When in BYPASS mode, this will release one chaff bundle. If not in BYPASS mode or OFF, it will initiate manual program 5.

# APPENDICES



# ALIC CODES & RWR SYMBOLS APPENDIX

The Aircraft Launcher Interface Computer (ALIC) codes listed under the "ID" column in the Air Defense and Naval Radar Systems tables can be used to program the AGM-88 HARM missile in [Pre-Briefed \(PB\) mode](#).

The Class codes listed under the "CLASS" column in the Air Defense and Naval Radar Systems tables can be used to filter emitter types for the AGM-88 HARM missile in [Target Of Opportunity \(TOO\) mode](#).

The threat radar codes under the "RWR" column correspond with how the threat radar will appear on the [ALR-67\(V\) Azimuth Indicator](#) or the DDI when the AGM-88 TOO mode is selected.

Air defense radar systems are further identified by their type. The table below lists the definition of each "Type" abbreviation to identify the radar's function within their respective air defense units.

TYPE	DESCRIPTION	TYPE	DESCRIPTION
<b>CWAR</b>	Continuous-Wave Acquisition Radar	<b>STR</b>	Search and Tracking Radar
<b>EWR</b>	Early Warning Radar	<b>TAR</b>	Target Acquisition Radar
<b>FCR</b>	Fire Control Radar	<b>TI</b>	Target Illumination
<b>RR</b>	Ranging Radar	<b>TTR</b>	Target Tracking Radar
<b>SR</b>	Surveillance Radar		

## Air Defense Radar Systems

ID	CLASS	RWR	NATO SYSTEM	SYSTEM	RADAR DESIGNATION	TYPE
-	-				1L13 "BOX SPRING"	SR / EWR
-	-				5G66 "TALL RACK"	SR / EWR
<b>122</b>	<b>H1</b>		SA-2 / SA-3 / SA-5	S-75 / S-125 / S-200	P-19 "FLAT FACE B"	SR / TAR
<b>126</b>			SA-2 "GUIDELINE"	S-75	SNR-75 "FAN SONG"	TTR
			SA-2 "GUIDELINE"	S-75	RD-75 "Amazonka"	RR
<b>123</b>	<b>H1</b>		SA-3 "GOA"	S-125	SNR-125 "LOW BLOW"	TTR
<b>130</b>			SA-5 "GAMMON"	S-200	ST-68U "TIN SHIELD"	TAR
<b>129</b>			SA-5 "GAMMON"	S-200	5N62 "SQUARE PAIR"	TTR / TI
<b>108</b>	<b>H1</b>		SA-6 "GAINFUL"	2K12 Kub	1S91 "STRAIGHT FLUSH"	TAR / TI
<b>117</b>	<b>H1</b>		SA-8 "GECKO"	9K33 Osa	"LAND ROLL"	TAR / TTR
<b>104</b>	<b>H2</b>		SA-10 "GRUMBLE"	S-300PS	64N6E "BIG BIRD"	TAR
<b>103</b>	<b>H2</b>		SA-10 "GRUMBLE"	S-300PS	5N66M "CLAM SHELL"	TAR
<b>110</b>	<b>H2</b>		SA-10 "GRUMBLE"	S-300PS	30N6E "FLAP LID"	TTR
<b>107</b>	<b>H2</b>		SA-11 "GADFLY"	9K37M Buk-M1	9S18M1 "SNOW DRIFT"	TAR
<b>115</b>	<b>H2</b>		SA-11 "GADFLY"	9K37M Buk-M1	9S35 "FIRE DOME"	TTR
<b>109</b>	<b>HS</b>			PPRU-M1	9S80M1 "DOG EAR"	TAR

118			SA-13 "GOPHER"	9K35 Strela-10M3	9S86 "SNAP SHOT"	RR
119	H2		SA-15 "GAUNTLET"	9K331 Tor-M1	"SCRUM HALF"	TAR / TTR
120	H2		SA-19 "GRISON"	2S6M Tunguska	1RL144 "HOT SHOT"	TAR / TTR
121	HAA			ZSU-23-4 Shilka	RPK-2 "GUN DISH"	FCR
131				S-60 / KS-19	SON-9 "FIRE CAN"	FCR
128			CSA-7 / HQ-7B	Hóng Qí-7	HQ-7 ACU	TAR
127			CSA-7 / HQ-7B	Hóng Qí-7	Type 345	TTR
-	-				AN/FPS-117 "SEEK IGLOO"	SR / EWR
203	H1		MIM-23B I-Hawk		AN/MPQ-50	TAR
204	H1		MIM-23B I-Hawk		AN/MPQ-46	TTR
206	H1		MIM-23B I-Hawk		AN/MPQ-55	CWAR
202	H2		MIM-104C Patriot PAC-2		AN/MPQ-53	STR
209			NASAMS 2		AN/MPQ-64F1 "Sentinel"	STR
208	HAA		M163 Vulcan ADS		AN/VPS-2	RR
124			Rapier FSA		DN 181 "Blindfire"	TTR
125			Rapier FSA		Rapier PU	SR
205	H1		Roland TÜR		MPDR-3002S	SR
201	H1		Marder Roland		MPDR-16 / DOMINO-30	TAR / TTR
207	HAA		Flakpanzer Gepard		MPDR-12 / Albis	TAR / FCR

## Naval Radar Systems

ID	CLASS	RWR	SHIP CLASS	TYPE	DESIGNATION
301	HN		Kuznetsov class	Heavy Aircraft Cruiser	Project 1143.5 (Admiral Kuznetsov)
320	HN		Kuznetsov class	Heavy Aircraft Cruiser	Project 1143.5 [2017 SC revision]
313	HN		Kirov class	Guided Missile Cruiser	Project 1144.2 (Piotr Velikiy)
303	HN		Slava class	Guided Missile Cruiser	Project 1164 (Moskva)
319	HN		Neutrashimy class	Guided Missile Frigate	Project 11540 (Neutrashimy)
309	HN		Krivak II class	Frigate / Guard Ship	Project 1135M (Rezky)
306	HN		Grisha class	Anti-Submarine Corvette	Project 1124.4 (Grisha)
312	HN		Tarantul III class	Missile Corvette	Project 1241.1 (Molniya)
321	HN		Ropucha I class	Large Landing Ship	Project 775
410	HN		Luyang II class	Guided Missile Destroyer	Type 052C (PLAN)
409	HN		Luyang I class	Guided Missile Destroyer	Type 052B (PLAN)
411	HN		Jiangkai II class	Guided Missile Frigate	Type 054A (PLAN)
408	HN		Yuzhao class	Amphibious Transport Dock	Type 071 (PLAN)

403	HN	SS	Nimitz class	Aircraft Carrier	CVN-71 (USS Theodore Roosevelt)
404	HN	SS	Nimitz class	Aircraft Carrier	CVN-72 (USS Abraham Lincoln)
405	HN	SS	Nimitz class	Aircraft Carrier	CVN-73 (USS George Washington)
406	HN	SS	Nimitz class	Aircraft Carrier	CVN-74 (USS John C. Stennis)
413	HN	SS	Nimitz class	Aircraft Carrier	CVN-75 (USS Harry S. Truman)
	HN	U	Forrestal class	Aircraft Carrier	CV-59 (USS Forrestal)
407	HN	49	Tarawa class	Amphibious Assault Ship	LHA-1 (USS Tarawa)
315	HN	AE	Ticonderoga class	Guided Missile Cruiser	CG (USS)
412	HN	AE	Arleigh Burke class	Guided Missile Destroyer	DDG (USS)
401	HN	49	Oliver Hazard Perry class	Guided Missile Frigate	FFG (USS)
	HN	U	Invincible class	Light Aircraft Carrier	R05 (HMS)
	HN	U	Leander class	Frigate	F12, F57, F72 (HMS)
	HN	U	Castle class	Patrol Class	P258, P265 (HMS)
	HN	U	Condell class	Frigate	PFG-06, PFG-07 (CNS)

## Airborne Radar Systems

RWR	AIRCRAFT	RWR	AIRCRAFT	RWR	AIRCRAFT
19	MiG-19	JF	JF-17	F4	F-4
21	MiG-21	29	J-11	F5	F-5
23	MiG-23	50	KJ-2000	14	F-14
24	Su-24			15	F-15
25	MiG-25	F1	Mirage F1	16	F-16
29	MiG-29	M2	Mirage 2000	18	F/A-18
29	Su-27	F2	Tornado GR4	E2	E-2
29	Su-33	U	Tornado IDS	E3	E-3
30	Su-30	U	AJS37		
31	MiG-31				
34	Su-34				
50	A-50				

## Other Threat Symbols

RWR	TYPE	THREATS
M	Missile radar seeker detected	Active radar-homing missiles (ARH)

# FORMULAS APPENDIX

Use these calculation and conversion formulas for pre-mission planning or while in flight. Desired resultants are bolded.

## Fuel/Endurance Calculations

**Bingo Fuel (lbs)** = (Time of Flight ÷ 60) × Fuel LB/HR

**Objective Time (mins)** = ([Total Fuel – Bingo Fuel] ÷ Fuel LB/HR) × 60

## Speed/Time/Distance Calculations

**Ground Speed Required (knots)** = (Distance ÷ Minutes) × 60

**Time of Flight (mins)** = (Distance ÷ Ground Speed) × 60

## Fuel/Range Calculations

**Specific Range Factor** = Ground Speed ÷ Fuel LB/HR

**Flight Range (NM)** = Specific Range Factor × Total Fuel

## Distance Conversion

NM to **Km** = [NM] × 1.85

Km to **NM** = [Km] ÷ 1.85

## Altitude/Elevation Conversion

Feet to **Meters** = [ft] ÷ 3.281

Meters to **Feet** = [m] × 3.281

## Latitude/Longitude Conversion

DDD-MM-SS.SS to **DDD-MM.MMM**  
 $SS.SS \div 60 = .MMM$

DDD-MM.MMM to **DDD-MM-SS.SS**  
 $.MMM \times 60 = SS.SS$

**Good hunting!**

**The Eagle Dynamics SA team**

**EAGLE DYNAMICS SA © 2020**

